

21ST CENTURY KILNS

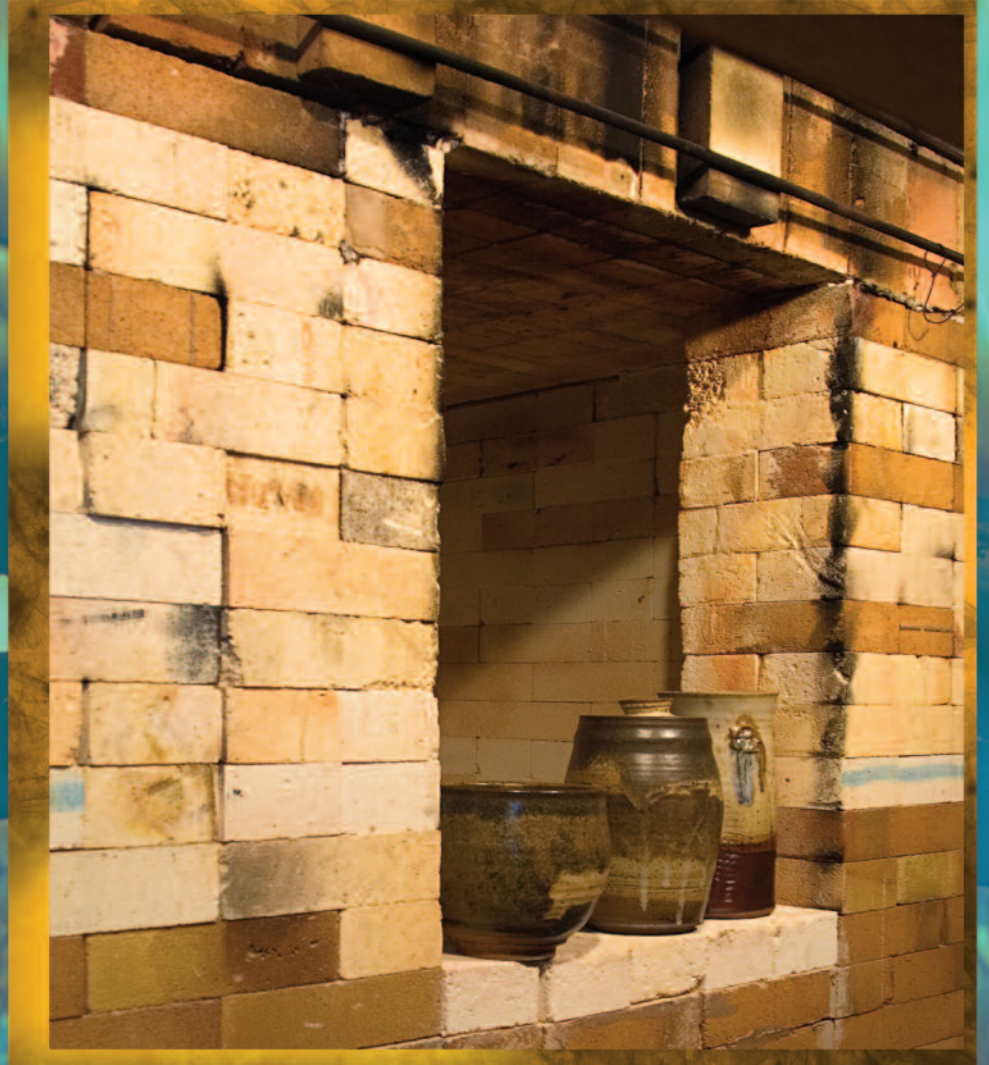

Mel Jacobson & Friends

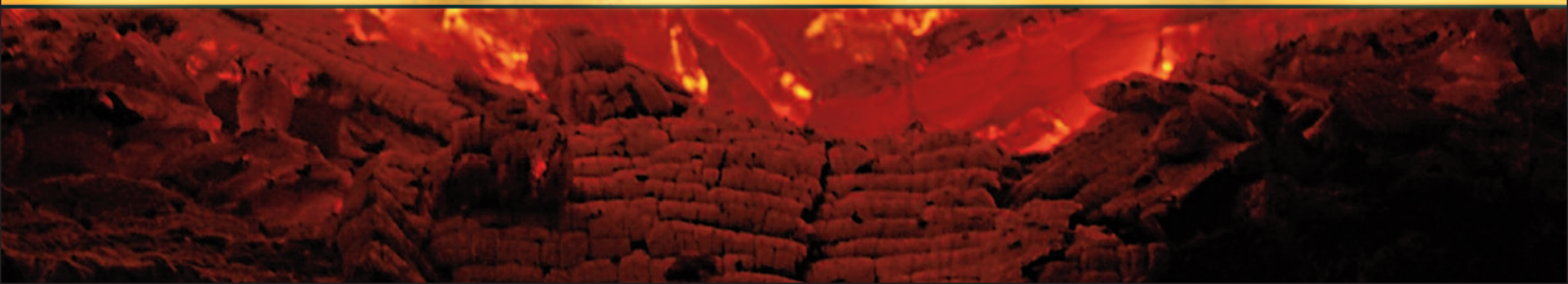



Mel Jacobson
melpots@visi.com
www.21stCenturyKilns.com

© 2010 Mel Jacobson

CONTENTS

1	MAKE A PLAN	3
2	BASIC KILN BUILDING STEPS	21
3	KILN STORIES: FLAT-TOPS	59
4	KILN STORIES: ARCH-TOPS	77
5	KILN STORIES: AN ARCH-TOP SODA KILN	91
6	KILN STORIES: KILNS WITH MOVABLE TOPS	111
7	KILN STORIES: ABERNATHY STYLE KILNS	123
8	KILN STORIES: CAR KILNS	133
9	KILN STORIES: SMALL WOOD-FIRED KILNS	143
10	KILN STORIES: LARGE WOOD-FIRED KILNS	173
11	KILN STORIES: A GAS/ELECTRIC KILN	189
12	FIRING SAFETY TIPS FOR GAS KILNS	193
13	FIRING TIPS FOR GAS KILNS	201
14	ELECTRIC KILN SETUP AND FIRING	217

FOREWORD

by Nils Lou

When potters gather in groups of two or more, the subject of kilns and firing and clay bodies and glazes often flavors the conversation. It's as if “real” life is centered on mud and how to play with it, harden it and change it from one state into another. We are fascinated with the alchemy that describes our addiction/profession.

I am particularly interested in the premise of this book because it addresses the extraordinary creativity of clay folk in solving the rigors and dilemma of constructing a custom firing solution while establishing the smallest possible footprint in the carbon environment. These are only some solutions to the infinite number of ways kiln architecture can be interpreted and expressed. They should especially interest readers who are presently considering “building their own.”

Mel Jacobson has gifted us with this compilation of firing practices and kiln designs demonstrating the wide and creative range of approaches and solutions to urban/suburban constraints on fuel-fired kilns. While bureaucratic regulations are less obstructive for rural potters, they face their own limitations—with

fuel solutions that demand researching unique firing practices, some even invented in ancient times. The re-emergence of wood firing is an important development having, perhaps, the longest history of any fuel for pottery making. As fossil fuels become less available—as they eventually will—reliance on renewable carbon/hydrogen energy forms will become necessary. Wood is just one possibility. Methane gas production from established landfill operations is already in the works. Co-generation of energy from recycling organics, like tires, will play a part. Solar energy has been used in limited form to fire small kilns. Surprisingly, natural gas may develop as a considerable resource as technology is finding creative ways to extract it from difficult geologic sources.

In the compendium that follows we find both traditional and unconventional solutions for building and firing one's own kiln. These are innovative designs that will inspire and surprise. All are successful to some degree—the success may be that of simply accepting the limitations of the design as the process is experienced when the first product emerges.

As potters embark on the idea of building their own kilns they often begin by exploring and researching existing designs. Some start with the idea of stacking bricks—an architectural approach. Some begin by anticipating what fuel is available and how to use it efficiently, i.e., how to focus the heat where you want it. Others may think first about what they want the product to become and work backward from there. It's not just heat being controlled, but atmosphere—and carbon. These are all valid approaches—they tend to reflect the individual nature of the kiln designer/builder.

John Neely has postulated that all the kilns we potters fire on any given day introduce less carbon dioxide into the atmosphere than one airliner making a cross-continent trip. But even so, our judicious use of carbon-based fuel does count. We can be stewards of our profession by learning how to efficiently monitor combustion to more precise needs. Kilns with carbon black that tattoo their exteriors still proliferate. It is not a sign of an educated potter. It should embarrass us. The kilns illustrated here in Mel's book inspire me—I hope they will inspire you.

While the book is about kilns, we must realize it is also about the magic that transpires when clay is heated. Molecules of carbon, oxygen, hydrogen, silica, aluminum and numerous others are stirred, agitated and metamorphosed—all by simply heating the ceramic in a controlled atmosphere and managing the process. Put in the BTUs, stir and exhaust with a taste of control. That's all there is to it.

CONTRIBUTING AUTHORS

Bob Anderson
 Reg Behrends
 Kerry Brooks
 Bill Burgert
 Ellen Currans
 Tim Frederick
 Bob Fritz
 David Hendley
 John Hesselbreth
 Halldor Hjalmarsen
 Arnold Howard
 Mel Jacobson
 Robert Klander
 Pat Lindemann
 Nils Lou
 Carol Marians
 Bill Merrill
 Steven Mills
 Hank Murrow
 Ted Neal
 Fred Paget
 Diana Pancioli
 Vince Pitelka
 Donovan Palmquist
 Betsy Price
 Ron Roy
 Bill Schran
 Marcia Selsor
 Stephani Stephenson
 Chris Trabaka
 Michael Wendt
 Kurt Wild
 Tom Wirt

RECOGNITION

Special recognition is given to Nils Lou of Oregon. His years of working with kilns and his wonderful book, *The Art of Firing*, has been an inspiration to many potters, including this author. Nils has been a close friend for years. We fought the early fight to bring soft brick kilns to the attention of potters. The work of Iowa potter and teacher Jim McKinnell was very important to all of us. Jim was a pioneer in the use of soft brick in the 1950's. Jim was the first to create a flat-roof kiln. Nils refined that idea, and when he invented the basic welded angle iron brackets for the corners of his now famous "Minnesota flat-top," a new kiln was born. The use of those brackets with the concept of a smaller flue and a tight firebox and chimney has given the world a very fine functioning kiln. It is easy to build and easy to fire, and when built to his specifications it will fire fast and with attainable economy.

Fred Olsen has also paved the way to open the minds of potters to the great potential of building kilns that fit the potter and the style of pots that a potter wants to make. We would also like to thank J.T. Abernathy for his innovative thinking and his concern to help many have

better, more efficient kilns and pottery tools. The generosity to share new information and to help those coming into ceramics is the key to the next generation of potters.

It is also critical that I mention Feriz and Alice Delkic. It is with great love and fondness that we remember how Alice cared for potters and wanted to help them by having ITC thermal coatings be a part of our kilns. We salute Feriz and remember Alice with every new kiln built. Nils and Feriz have been the teachers of science and engineering that have made me a better potter and a person who understands the modern kiln.

Joe Koons has been my faithful friend and a life long student of glaze. His leadership and passion for Chinese Glazes has led me to wonderful projects and collaborations. We work together, share ideas and take huge leaps in understanding how pots, glaze and fire come together to make great art and craft. My life is very rich with Joe in it.

Thermodynamics and the science of fire are what kilns are about. They are not about "feelings, wishing, or kiln gods;" they are based

on good engineering principals. A well-designed and perfectly functioning kiln will save the potter time, energy and money. We hope this book will help potters find that perfect balance of building kilns and firing them with perfection.

This book contains many thoughts, ideas, and plans. Each is the result of a potter who wanted to control his or her firing, or a person who is an expert in a phase of pottery production. And, of course, this book has ideas from many who have worked diligently to update, make new, and approach ceramics as an ongoing, changing craft.

At times the reader may encounter duplication of thought or ideas, and that is okay. We hope that there is a consistency of information. With so many ideas, you will have to sort through the book to find what is right for you and what will work in your location. Most of the information in this book comes in suggestion form. You should be able to adjust plans for size and shape and adapt things to suit your specific needs and location.

We invite you to copy plans, download and print material as you need it. Just keep in mind that you cannot duplicate for sale anything in this book. It is for you, and you alone, to use and copy.

Mel Jacobson

©2010 Mel Jacobson and Friends

ACKNOWLEDGEMENT

Special thanks to Cindy Thompson of Greatapes for her amazing work formatting and editing this book. David Hendley and Bill Schran scanned the manuscript for errors and added comments and suggestions to complete this work. And of course, thanks to the many that added their help, stories, and film to create a very unique picture of kiln construction and firing.

This book would not have been possible without the help and support of Jim Woelm, owner of Greatapes. Jim and I have been friends since grade school. He is a gem.

ABOUT THE DVD AND WEBSITE

The DVD contains videos of many of the kilns presented here. It also contains a pdf of this book.

Additional information and resources on kiln building and firing can be found at the companion website: *21stcenturykilns.com*

Cover photo of fire by R.P.Washburne.

“Every man’s work shall be made manifest: for the day shall declare it, because it shall be revealed by fire; and the fire shall try every man’s work of what sort it is.”

(1 Corinthians 3:13)

INTRODUCTION

Since the beginning of time people have been adding clay to fire. Understanding and controlling it is what helped humans turn from raw animals into thinking and tool-making people. Fire has always been one of the great mysteries of life and, without doubt, the greatest technology of every society since the beginning of humankind.

This book will help those potters who would like to build their own kilns on their own property. You’ll learn the ins and outs of the planning process as well as the basic steps of kiln construction. You’ll gain valuable insight and advice from contributors from across the country who have built their own kilns. These builders share their kiln-building stories, step-by-step procedures, and tips and tricks for constructing a variety of fuel-fired kilns.

Kiln safety considerations and firing tips are also presented so you can fire safely and efficiently. And no book on kiln building would be complete without a discussion of electric kilns. You’ll learn how to convert your electric kiln to a gas/electric hybrid. You’ll also learn about recent advances in electric kiln technology, firing schedules, maintenance, and repair.

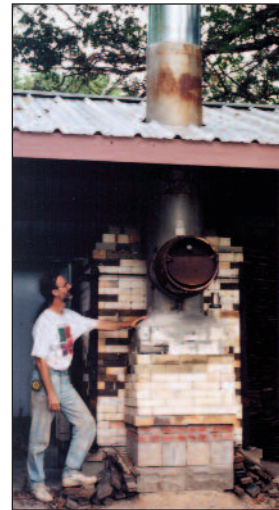

photo : Karen Hendley



photo : Elizabeth Priddy



photo : Pat Lindemann

It Can Be Done!

Home kilns are being fired in big city backyards, backwoods clearings, in the chilly winds of the north, and under the hot Florida sun. They are being built by retirees, by students, by those with vast building experience, and by those who have none. What all these folks have in common is the will to find out what needs to be done and the drive to follow through and do it. You, too, can become one of those intrepid folk.

Important Disclaimer

All of the kilns in this book and their companion plans and firing instructions are offered only as ideas that have worked for others. Each kiln built will be unique and its success will depend on the quality of materials used, the attention to good construction practice, and even the region of the country in which it is built.

We offer these plans and suggestions in good faith, but we do not guarantee that they will work perfectly or be completely safe. You must follow strict safety guidelines and obey local codes. Check with your insurance company and local officials if you are concerned about building issues. Be aware that every region in the country has its own special differences and each energy company has different safety guidelines that must be followed. That is your responsibility as the builder. One size does not fit all.



photo : Andy Kazukewicz



photo : Ted Neal

1

MAKE A PLAN

Before you build you need to make a plan. Many questions will need to be answered before the first brick is laid. Here are just a few:

- Can I get the blessings of my neighbors and permission from local officials?
- What kind of fuel will I use?
- What style and size of kiln will best fit the kind of ware I want to make?
- Where will I locate the kiln and how will I shelter it?
- What materials and tools will I need?
- What's my budget and my timeline?
- How can I incorporate safety and fuel conservation into all parts of this project?

Don't cut corners. Make the best kiln that you are able to build—one that will last for many years with safe and perfect firings, time after time.

STEP 1 Find Out About Necessary Permits and Get Approval from Neighbors

If you determine that you want to and are able to build a kiln on your home property, you must find out if you can do it without interference from your city, township or neighbors. This must be done before you start. In many cases people will not understand what you are doing. How a kiln works and how hot the firing will be is basically a mystery to the average citizen or city inspector.

Find Out About Local Codes

We do not expect you to disobey local codes and laws. But, without question, you must arm yourself with all the information and knowledge to counter any arguments that may cause your project to be eliminated before you start. The kiln building stories in this book and the videos on the DVD will help you understand how others have gotten over these hurdles.

Each city and municipality has a set of rules and regulations that must be followed when building any heat-producing enterprise. You must check with your local code office in your municipality. Get a copy of the code manuals. This will give you good ammunition and ideas for approaching local officials about your construction project.

Codes may already be in place for outdoor fireplaces or outdoor heating facilities. A kiln will often fall into these categories. Sometimes the only issue a city office will have is over the space around the kiln or the distance from lot lines. Each case will be different, and each issue can be resolved in a unique way.

If you head to your local zoning board or neighbors and announce that you are building a pottery kiln that fires to 2400°F and uses a million BTUs of gas, you will more than likely frighten them. They just won't understand. Using the terms "hobby or art research" is one way to address the project. Underplay vs. overplay will make all the difference. Use terms like "natural craft hobby" versus "going into production with a great deal of fire and gas."

Present yourself to public officials dressed well and speaking well. Be professional and knowledgeable, come with carefully drawn plans, and emphasize safety.

Consult Your Insurance Company

The same advice applies to dealing with your insurance company. It is critical that you check with your own insurance company before you build your kiln. Outdoor kilns with proper distance from buildings will almost always be accepted. When you place a kiln in a garage or

attached building to your home, the insurance company will want assurances that it is safe.

You want your insurance people to understand what you are doing, and to be assured that safety is your primary concern. Do not cover up issues with an insurance company—they could come back to haunt you.

Show that your kiln is safe and away from other structures. Make sure that you have strong buffers that will never allow the kiln to burn down your house or garage. Show that you have high quality fire extinguishers and other safety tools on site and near the kiln. Have a safety plan.

Consult Your Neighbors

Last, but not least, get the blessings of your neighbors. When folks know and understand that your kiln does not produce excess smoke or safety problems you will have greater cooperation. Make sure your plan includes shielding, handsome construction, and decorative plants and trees to enhance your property.

STEP 2**Choose Your Fuel**

Everyone wants to start talking about kilns with the word *bricks* and the concept of architecture. That is not how you start a discussion on kilns and firing. We start with the word *fuel*. What is available, how much is available, how much does it cost per heating unit, and will it be there a year or ten years from now? Is the fuel safe, dependable, easy to control, and will it be enough heat? And is the fuel appropriate to the style of the ceramic work? Your kiln must be planned and organized from the start with your fuel as the most important consideration.

Discovering a fuel that will be available over the long term, one that will be clean and energy efficient and will not send smoke or vapors across your neighbors' property is the first place to start. We know we cannot build a wood-fired kiln in downtown Manhattan. (It would be noticed.) The same applies to your own home. Can you build a fuel-fired kiln that will comply with local ordinances? Can you make pots, fire them, and still have a happy home and neighborhood?

Natural Gas

If it is available, natural gas is the best choice for a fuel kiln. It is clean, stable, and safe and will not cause any smoke from your stack. Your neighbors will never know when you fire; it will be a non-issue.

Most of us were first introduced to fuel firing at a college or art center. It was most often a large kiln made for maximum indoor safety and large production—a commercial kiln. Most public schools or art centers are designed and constructed with commercial property

specifications. The gas line coming into that building is generally 2–3 inches in diameter, with a gas pressure of at least 10 inches of water column (wci). The average home has much less gas pressure, often about 7 wci, and some have even as low as 1 inch of pressure.

Depending on the weather in your region, the gas you get may be just enough to fire a small furnace. If you live in a northern, cold winter state the gas pressure is increased.

With 10 inches of pressure you could fire 3–4 kilns at the same time. With 1 inch+ of pressure you may have just barely enough to accommodate your kiln, your furnace and a water heater.

Gas Pressure is Measured in Water Column Inches

Though you may be familiar with pressure expressed as pounds per square inch (psi), natural gas pressure is often measured on a different and much lower scale.

Units of gas pressure are often expressed in water column inches (wci). This is the number of inches water in a glass column could be lifted by the pressure of the gas.

One inch of water column is equal to .036 psi. (One pound per square inch is equal to 27.76 inches of water column.)

Though the natural gas that comes to your house arrives at a higher pressure, it is reduced in pressure by a regulator for use in your home.

The pressure you use to run your home appliances may be around 7 inches of water column (about $\frac{1}{4}$ psi).

If you are thinking of a gas kiln on your home property, it is critical that you have your pressure checked. This can be done by a plumber or representative from your gas company. You must find out if you need more gas pressure and if it is available.

You do not need 10 inches of pressure; in fact you may be able to get more than enough gas if the *volume* of gas is increased. There are two factors with gas: 1) *pressure* in the pipe provided by the gas company, and 2) the *volume* of gas, which is dependent on the diameter of the pipe. Every region, county or city has a different set of specifications to deliver natural gas.

If you know you have ample gas pressure and you can run that gas to your kiln, you have many interesting options, and there is no cap on the temperature that you can fire.

Propane

Propane is generally more expensive than natural gas and is used in rural areas where natural gas is unavailable. “Bottled” gas that can be delivered to your house is a great firing option. If you are considering propane, make a trip to your local dealer and get acquainted with the dealer and the driver. Check to see if there is more than one dealer in your area and investigate prices and delivery schedules. Be sure to check on the sizes of tanks you can buy or rent.

Consider the Size of Tank You Need

The larger the tank, the fewer problems you have to deal with. In most cases a 500-gallon tank will be more than adequate, but if you are going to fire a large kiln, check on a 1000-gallon tank. In many regions a truck

will not fill any tank smaller than 250 gallons.

If you are considering 100-gallon tanks in tandem, you may have to haul those tanks to a fill station yourself, and that is not an easy task. If you lease the tank from the fuel company there is often a fuel-use commitment per season. It is often better to purchase the tank and schedule fuel deliveries according to your production and firing schedule.

The larger the capacity of the gas tanks, the more you can fire them without freeze-up. Small tanks are much more prone to freezing. Always try to obtain the largest gas container that you can get or afford.



photo : Tom Wirt and Betsy Price

Tom Wirt and Betsy Price's 1000-gallon tank. It includes a wireless sensor (left top) that feeds an indoor tank readout. The gas company added it at no cost. It phones them for automatic refill. On the right end of the tank is the liquid tap. Besides feeding the kiln, they can fill 20-gallon cylinders and the LPG fork lift tank.

Propane is more dangerous than natural gas. It can leak as a liquid or gas and will pool in the lowest place near your kiln. If that should happen, you risk an explosion with a huge fireball of flame. As with all gas, being cautious, careful and prudent is the rule.

Alternative Fuels

Alternative fuels like wood, pellets, and waste oil can produce both great firing effects and cost savings. But you must be prepared for a great deal of work to make sure the supply of such fuel is on hand. Gathering, chopping, and storing wood requires a good deal of time and effort.

Potters have been known to secure supplies of waste vegetable oil from fast food restaurants. It works and does fire a kiln, but the gathering and storage of waste oil is a huge endeavor. Often the money saved is not enough to compare with the work it takes to acquire the materials. Time spent in the studio would be far more productive.



photo : Donovan Palmquist

Plan how you will gather and store your fuel.

Consider Your Fuel Source When You Choose Your Site

Where will your gas line be? Will you bury the line, and, if so, how deep? The kiln's location will depend on the source of your fuel. If you use propane you have more options, but you must have room to site the tank at least 25 feet from the kiln, and have a road for the fuel truck.

For those who are using wood or other alternatives, consider how and where you will gather and store your fuel.

Choose Your Kiln Style

Each kiln type has its own advantages and disadvantages. Here are a few styles that appear in this book:

Flat-Top

Without question, this is the easiest kiln to build. The size and shape is very flexible, and two people without any real experience can follow the plan and build it in two or three days.

The flat-top is easy to build, rebuild, and take down and move. It also uses only one style of brick—the “Norman” or standard-size brick. It does not require over-sized brick, or arch- or wedge-style brick. And most of the bracing materials can be found at your local hardware store.

This type of kiln is best used for standard gas reduction firing or basic oxidation firing. It will fire at most any temperature up to cone 12. It is almost drawback free. This is a great kiln for a backyard construction project.

Arch-Top

The arch-topped kiln is beautiful and has great historic relevance. It is obviously more complex to build.

All arch kilns need metal support and a good deal of welding. The skewback brick that supports the arch must be backed up with solid metal welding support. The thrust or energy of the arch follows from the skewback down the outside of the kiln and runs to the floor through solid metal bracing. That bracing must be attached to the concrete floor with pins or bolts driven into the floor.

There will be some math involved in building a quality arch. The bricks to make the arch will include straights, arch, and wedge style. These are more expensive than standard-size bricks. You will use a precise combination of these three different brick styles to make the arch.

The arch will allow more top or headspace, but the brick must be cut to fit the arch both in the front and back of the kiln. These bricks must be form fit and placed back in the same position each time. Kaowool fiber packing will aid the potter in getting a tight seal for the door. The cut brick should be soft brick that can be cut carefully with handsaws.

Traditionalists love these beautiful arch kilns. They will argue that this is the only way to build a kiln. Many modern kiln builders will argue that it is old technology. No one wins this debate. It is up to you, the builder, to choose.

Movable-Top

Kilns that lift are very easy to load and “get at.” They use complex counter balance systems that require strong support above the kiln. In other words, you need a structure above your kiln. That structure must be able to support the entire weight of the kiln, lifting it over and over.

Heavy kilns will require equally heavy counterweights, as well as heavy-duty pulley hardware and strong cables to hold the weight. You must also have a good system to hold the kiln in its upright position. This must not be overlooked or minimized.

Without question a lifting style of kiln takes a great deal of planning and a complete understanding of how the kiln will lift. It must be

flawlessly designed and safely constructed. But they can be wonderful kilns.

Many movable-top kilns are used for raku firing. In that case the kiln does not have to be huge or heavy and can be made entirely of ceramic fiber.

Car Kilns

Without doubt, car kilns are the easiest kiln to load. When the car is in the “out” position it is ready to be loaded with shelves and pots. It is then pushed into the kiln to fire.

A car kiln needs a very flat, smooth floor and double the space of an ordinary kiln. The footprint is big. The floor has to be smooth so the car can be pushed into the kiln on rails and not vibrate, wiggle or stall. The action of the car being pushed must be smooth enough so the ware does not fall over.

Production potters love the car kiln design. The ease of loading is a big factor when you fire often and have schedules to keep.

Car kilns are expensive as they need more space, more brick, and more complex metal work. You will often see car kilns inside their own special buildings. The expense and space is often offset by the increased production and energy saving by the potter. Kiln builders like Donovan Palmquist prefer this design for art centers, colleges and professional potters. This is, without doubt, a terrific kiln design if you have the funds to afford one.

Train and Wood-Fired Anagama Kilns

The two plans we have included in this book are great examples of wood-fired kilns. Both have good track records, and they could be built by a group of potters with some basic knowledge of kiln construction.

Wood kilns by nature are large and very expensive. They take masses of brick. A project of this nature takes a lot of planning and long-range commitment. As sources of fuel dry up, the amount of work gathering fuel can become overwhelming. This must be factored in long before the project begins.



Flat-Top Kiln

photo : Bill Burgert

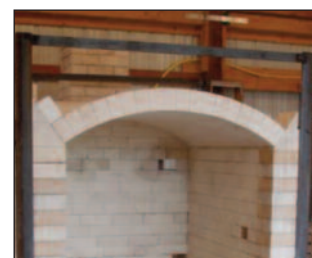

Arch-Top Kiln

photo : Calleen Reilly



Movable-Top Kiln

photo : Marcia Selsor



Car or Shuttle Kiln

photo : Halldor Hjalmarson



Train Kiln

photo : Ted Neal

Salt and Soda Kilns

Any kiln design can be adapted to salt and soda—it is just prudent to use hard brick on the interior. Salt is very corrosive. It eats brick.

Some potters have found that spraying a shino glaze on the interior brick makes for a great pre-coating for the kiln. It is often economical to have a second layer on the outside of the kiln made from soft brick as added insulation.

There have been many attempts to construct kilns with soft brick coated with thermal coatings, and it works. But, the coatings are expensive, and the brick must be soaked entirely in the coating material. ITC (International Technical Ceramics thermal coating) is often used for this coating with success.

Whatever you do, the kiln will have a limited time before the inside begins to deteriorate. This must be taken into account. It's not impossible to re-brick a salt kiln.

Arch-Top vs. Flat-Top Design

The classic arch system is the most common salt kiln design, with a hard brick first course.

However, using a flat-top design makes it easier to take apart and rebuild the kiln when the time comes.

Regardless of the design, if the roof is made of hard brick, the span of the roof must be kept reasonable, because of the tremendous weight. Also, the corner brackets and the rods holding the roof must be oversized to accommodate the heavy hard brick.

STEP 4

Research Kiln Building

Get a copy of Nils Lou's book *The Art of Firing* and read it cover to cover. Then read it again. It has a wealth of information on the science and theory of firing. These concepts are rarely covered in kiln-building manuals. This is critical information for any kiln builder.

Another valuable resource is *The Kiln Book*, by Fred Olsen.

Novice kiln builders are advised to stick to kiln plans that have been proven to work rather than designing their own plans.

STEP 5 Determine Your Kiln's Size

As you plan fuel, kiln, and shelter, think about how many pots you make in a week. Know your construction style as well as your pottery schedule. If you can figure the number of pots that you can make in any cycle, you will know how big to make your kiln.

One of the most noted phrases in pottery is “chasing your kiln,” in other words, having a kiln too big to fire on a regular basis. It has been said many times, a kiln too big will be far more difficult for you than a kiln that is too small. When your kiln is too large, the risk of failure is always looming over your firings. Can you afford to lose an entire load of hundreds of pots?

It is far better to plan and organize your kiln size around the work that you *know* you will be able to produce.

The question to ask about sizing your kiln is, How much experimentation are you going to do? You will want a kiln that you can fire on a regular basis and still fire an experimental load. A huge kiln will never allow you to do that.

That said, there is no magic size for kilns. That decision is always in the hands of the person making the kiln. Let accurate and realistic analysis of how you work and how much you produce be your guide.

Remember, this is a lifetime plan. You can always rebuild a kiln if you need more space, if the shelter, the gas or fuel is already in place. Many potters have raised their kiln roofs, added a few more bricks to the sidewalls, and gained a fourth more space. It's easy to do.

Kiln Shelf Size Helps Determine the Size of the Kiln

The inside floor size should always be based on how many stacks of shelves will fit the space.

In other words, start planning your kiln around kiln shelf size, not an arbitrary kiln size. Find out what sizes are available. For most home kilns, two stacks of shelves about 12" x 24" would be good. So, rule of thumb, you would need 24" x 24" with about 6" around the shelves and 2" between stacks. That makes the floor somewhere about 36" to 45" plus. It is always prudent to allow extra room around the shelves. Do not crowd them.

Calculate brick size (normal brick size is 2½" x 4½" x 9") and shelf size to give you a perfect floor footprint.

During the early stages of planning, using graph paper squares will help you calculate floor plan and shelf configuration.



photo: R.P. Washburne

Plan the size of your kiln around the number of pots you make.

Plan the Kiln to Fit Your Body

The height, width, and opening of the kiln door should be planned with the perfect measurements of your body in mind. You may have to lift those last high kiln shelves above shoulder height. If the kiln is too tall, you will not be able to place the last shelves. If the door is too low, you will always be stooping. It is very important to make sure the number of concrete blocks used as a foundation for your kiln bring the door of the kiln to the correct height: somewhere close to your waist. As for the door width, in most cases a two-and-a-half brick wide door is adequate. Larger potters may want a three-brick door (27" across). The author has used a two-and-a-half brick door for 50 years, and finds it very adequate.

STEP 6

Plan the Location

Consider the flow of work from your studio to your kiln and beyond. Plan your pad and kiln position to maximize efficiency and minimize bother to your neighbors.

A kiln close to your shop makes for a shorter distance to lug pots. Plan your kiln for easy access—it pays over the long haul.

Wind, sun, and rain will all affect loading and firing. What direction does the wind generally come from in your area? You do not want driven rain and snow coming into the door while you are loading. And you do not want heavy winds blowing against your burners. If you can, put them in the most sheltered position.

Avoid having your burners facing the neighbors. When your kiln gets hot and the flame is really intense, it may frighten them. Build a fence or natural screen of bushes to shield them.

Finally, look up! Do you have overhanging branches or phone/electrical wires that may cause problems?

A well-planned, well-located kiln is a joy. Hauling pots through snow in the winter is not.

STEP 7 Plan Your Shelter Now

The type of shelter or cover for your kiln varies by climate, local custom and regulations, and what you can afford to build. But, for sure, plan the shelter as you plan the kiln. The shelter may be one of those things that will come two years later, but plan it in.

(A kiln without a shelter must still be covered and protected from the weather.)

If you can, make the entire shelter fireproof. This means a steel structure and a metal roof. All roof systems should use metal corrugated material. It now comes in many styles and colors and can blend in with your current home design. Metal roofs just make sense.

If you are planning a small building to house your kiln, make sure it has plenty of ventilation. Power venting would be extremely smart. Good airflow will keep hot spots from occurring in the building. Keeping plenty of air space around the chimney is vital.

You will hear it from many potters; kiln sheds are often the first to go. Fire in a poorly made shed is a fairly common event. Never take a chance with a flammable, poorly designed shed.



The shelter may come later, but put it in your plans now.

photo : Bill Burgert

STEP 8**Determine What Additional Tools You Will Need**

Beyond the normal array of household hand tools, you may need these:

Tools

- Level
- Carpenter's large square
- String line and chalk
- Big colored chalk marker
- Respirator/simple quality dust masks
- Soft hammer
- Chisels
- Bow saw for tree limb cutting and extra blades (used for cutting soft brick)
- Quality large torque wrench
- Set of wrenches for small work
- Electric drill and/or drill press
- Welder

Note: Many expensive or exotic tools can be easily rented for the day only.



photo : Andy Kazukewicz

Start gathering necessary tools.

STEP 9 Plan Your Budget and Timeline

Start a journal or note book with all the specifications and tools listed.

Calculate your budget and your proposed timeline for building. This is like a small military campaign; organization is key to success.

Before you build, study your plan and practice putting the pieces together. Use marking crayon or chalk to outline everything. Take pictures as you build each section of the kiln. Keep records on the source, style and type of materials you are buying.

Keeping a log and checking off each section of the plan as you are building will help you avoid making critical mistakes. Remember, it isn't easy to add a peephole after the walls are all built.

Never rush any part of the construction. If you are tired or losing daylight, call it a day. Seek perfection in all parts of the process. You will be rewarded with a beautifully firing kiln.

STEP 10 Plan For Safety

Consider what safety precautions you will need to take during the construction process:

Personal Safety

- How will you safely transport your materials to your site?
- Do you have the necessary protective equipment? These include gloves, boots, safety glasses, etc.
- Do you need to use a respirator? This will be necessary if you plan to cut ceramic fiber.
- Are you welding? Do you have the necessary eye protection and safety equipment?
- Do you have a first aid kit?
- Do you have fire extinguishers on hand?
- Do you have a plan in case of emergency?

Public Safety

- How will you keep your worksite safe and protected from neighborhood kids?
- Have you called 811 to find out where existing utility lines are before you begin digging?
- If you are doing your own gas work, do you understand the safety procedures involved in installing a gas line?

Sample Kiln-Building Checklist

IMPORTANT NOTE : There is no place for alcohol or drugs during kiln construction. It is serious business that requires excellent quality control.

- Before you pour your concrete pad, check that soil is prepared and the form is perfectly square and level. Measure from corner to corner. Do **not** make a slant for water runoff.
- Install the gas line. (Call 811 before you dig.)
- Build concrete block kiln foundation. This must be level and firmly planted on the pad. No rocking blocks. Clean the bottoms of the blocks by rubbing them with a hard brick.
- Place expanded metal or hardy board over the concrete block. (Expanded metal is superior.)
- Make sure all bricks that you cut are cut square. Measure them.
- Place the first course of brick for the floor level and square. Double-check.
- Mark with chalk where your ports and door will be.
- Add two more rows of floor brick. Mark ports and door again with chalk.
- Start the sidewalls.
- Add lock-in bricks for chimney. Place one row perpendicular to the wall. Make the chimney a part of the back wall.
- Plan for peepholes as you build the walls.
- Plan the damper location as you build chimney.
- Continue to check that everything is level and square. Place your square in the four corners. Check all the way up.
- If small cracks or open space occur, stuff with fiber. Do this as you go to keep things square and tight.
- When you get to the top, lay in a thin gasket of fiber between walls and roof.
- Install the smokestack and liners.
- Secure the structure with angle iron and rods or turnbuckles and cable.
- Install the roof.
- Install burners, thermocouples, and BASO valves.
- Check and re-check all gas connections for leaks before firing.

It Has Been Done! Building an Urban Kiln by Bill Burgert

With persistence, a lot of planning and some skill, anybody can design, build and fire a gas fueled urban kiln. I was asked to share my story of the process I, a regular Joe, went through to do just that.



Photo : Bill Burgert

Bill Burgert's backyard urban kiln.

Mel invited me to Hay Creek, a gathering of artists and potters on a Wisconsin farm. During my experience at Hay Creek I had the chance to be an active participant in the firing of the kilns. There's something to say about the activity of firing a gas kiln—the sounds, the smells and the visual experience. They are all important to a successful firing. I helped clean and repair the old kilns and assisted in helping load and fire. I loved the relationship that happened with the other potters and the whole firing process.

When I got home from Hay Creek I knew I had to build a gas kiln. There were many questions I had to answer before any bricks were laid. I had to come up with a timeline and a master

plan. The old saying “measure twice, cut once” came to the forefront of my mind. I ended up drawing out a timeline for building the kiln.

The first thing I had to do was research. I planned the project in five stages: the kiln, the fuel, the pad, the burners and the shelter.

I had to:

- Decide what type of kiln I wanted to build—the design and fuel type.
- Figure out how big I wanted to build the kiln relative to the quantity and size of work I do.
- Locate the best place to build the kiln so it would be close to my studio, blend into the surrounding landscape, and be convenient to a fuel source.
- Determine what materials I would need for each stage, how much the materials would cost, and how long each stage would take to complete.
- Check the temperature of the neighbors and their feelings about having a kiln next door to them. “Say, I’ve been thinking about building a small kiln in my backyard...” This is only after I educated them about my art, what I was doing in my garage studio, and how it all works.

The Kiln

This was easy—I decided on the same small stoneware kiln as at Hay Creek. That was clearly a perfect kiln for me. It's a kiln I had fired numerous times; it's small enough that I could fill it with about a week's worth of work and it's a simple enough design that I could build it myself.

I gathered information on flat-top gas kilns from my experiences at Hay Creek and from Mel and Nils Lou. Once Mel realized that nothing was going to stop me from building a kiln in my back yard, he sent me the plans and decided to pay me a visit to oversee the project, which meant he sat in a comfortable lawn chair, sipping his cranberry and 7UP, while I did all the heavy lifting.

The Fuel

Natural gas was my fuel of choice because it was readily available. I drew the gas line route on graph paper, took measurements of the various segments of pipe and headed off to Home Depot to buy the precut threaded black pipe.

I was lucky enough to have a "T" right after the gas meter so tapping in to the line was no problem. I shut off the gas right before the meter, removed the plug that was in the "T" and installed a ball valve. Now I could work on the pipeline route to the kiln while keeping service to the house. The other benefit of installing a ball valve right at the meter is safety; I can shut off that whole line if I ever need to do any repairs. I put together the pipe with Teflon tape, following the route that I previously drew, all the way to the kiln site and ending with another ball valve.

I closed the last ball valve and opened the ball valve next to the meter so I could run a soap-water test on all the connections. After I confirmed that there were no leaks, I shut off the ball valve next to the meter and opened the ball valve at the kiln site to void the line of gas. I was ready to attach the burners that I hadn't made yet.

The Pad

The kiln is only as good as the foundation it's built on. I wanted to build a pad for the kiln that was flat and level. (Usually when you pour a concrete pad you design it with a slight tilt for drainage, but not in this case.)

My original thought was to hand mix ready-mix concrete, with a hoe, in a wheelbarrow. I did the math on how many bags I would need to make the 7' x 7' x 4" thick pad and thought, "I'm crazy—that'll take me forty years and two back surgeries." The next day I called a local concrete company who drove a truck out to my site and mixed as much as I needed, wheelbarrow by wheelbarrow load, with no waste and perfect consistency. Three hours later I was watching it cure.



photo: Bill Burgert

Don't forget the kids' handprints!

A basic “how-to” book on concrete was helpful. I referenced the one with Don Knotts on the cover: **Build and Repair With Concrete**, *The Complete Do-It-Yourself Manual* by Quikrete Companies Staff. It gives specific instructions on how to build the form and finish the concrete.

The Burners

You can spend as much money as you want on a set of burners. In my case, this project was on a tight budget. My alternative to buying a set of burners was to make them. All I thought the

Home Depot is great if you’re replacing an old sink or repairing a sprinkler system in your yard, but when it comes to specialized plumbing parts like the one I invented, Home Depot is very limited. A “Jack of all trades” friend of mine referred me to an old school wholesale plumbing supply store in South Denver that had everything I needed to construct the burners according to my plans.

The Shelter

I used the house framing experiences I learned while I was in college to build a simple wood

“What I know is, the kiln I’ve built is mine. I have fired the kiln many times and have learned to drive it like a Ferrari while getting the fuel economy of a hybrid.”

Bill Burgert

burners to be was a way to get fuel into the kiln. They are pretty basic simple mechanics. My models of choice for designing my own were a small propane torch and the burner system of a hot water heater, because they utilize thermocouples for safety.

I made a few rudimentary drawings to show scale and how everything was going to fit together. Plus, making the drawing first gave me a shopping list for the plumbing store. I refined the drawings on graph paper a few times and came up with a final.

I took my burner drawing to Home Depot (where most of the employees knew me on a first name basis now).

structure with a corrugated metal roof. It cost me about a hundred and fifty bucks, six or eight trips to my favorite Home Depot, and a weekend of work to allow me the satisfaction



Bill's homemade burner system.

photo : Bill Burgert

of staying in bed during a late night rainstorm. As an added bonus, the kiln is protected from the elements.

The First Firing

The first time I fired my fully loaded kiln I was scared to death. I recorded the temperature changes every thirty minutes. I continually fidgeted with the damper. I almost wore out the brick in the peephole. I called Mel fourteen times to advise him where the temperature was. On the fifteenth call he and Bob Anderson just laughed and said, “Let the damn thing alone. Set it and let it go.” The last time I called Mel to ecstatically tell him I had reached temperature and he said, “Fine, good. Before you shut her down, throw all your firing notes in the burner port, close it up and go to bed.” I fired it to cone six in about eight hours. I slept great.

All kilns fire differently. It might be due to the size of the kiln, the altitude it's built, the climate, the type of fuel or the burners. My kiln

is not the best in the world but it is perfect for me. What I know is, the kiln I've built is mine. I have fired the kiln many times and have learned to drive it like a Ferrari while getting the fuel economy of a hybrid. I can fire it slow or I can fire it fast. I can fire it in reduction or I can fire it in oxidation. I know where the hot and cold spots are. The results of my firings are not all perfect. I can also say that they are not the result of a poorly built kiln—but maybe the driver.

I can say with conviction that with my persistence, determination, help from friends and family and the love of clay, I planned, designed, and built a gas-fired urban kiln.

2

BASIC KILN BUILDING STEPS

The following are general steps for building gas-fired kilns. Bear in mind that you may follow a slightly different order when building your own.

STEP 1 Prepare the Site
Your soil must be stable. If you have concerns about it, ask a building inspector or general contractor to assess the stability of your yard. If your soil is judged to be poor it can be dug out and replaced with a quality soil and then topped with gravel. Pack it as tight as you can. You can rent a handheld soil tamper and pound the soil tight.

If you are going to have a concrete slab poured, your contractor will usually prepare the soil first, or he will have you do it to his specification.

What you don't want is wet, sloppy soil that will allow the base of the kiln to sink.

Many potters with poor soil just use a shovel and wheelbarrow to remove a foot or so of it and then add gravel as fill. If necessary, a group of holes can be dug below the frost line and filled with rock and cement, but this is only rarely needed.

STEP 2 Pour the Slab
Should you wish to pour your own slab, there are many good books available. If you prefer to use a concrete specialist, just make sure you can get concrete to your site.

The thickness of your slab depends on your climate. A 5" slab is recommended if you live where the ground freezes. If you live in a warmer climate, ask around to find out what your local practices are.

Rebar or screen can be placed into the form to help make it stronger, but a solid concrete slab will be just fine. Make sure the concrete is completely level. Most masons will want to add a slope for drainage—don't do it. Flat. Flat. Flat. We cannot build a house on a sloping foundation, nor can we build a kiln on a sloping foundation. If possible, oversize your slab, and give yourself some extra room to add a table or storage for your kiln shelves and furniture.

STEP 3 Install the Gas Line

Be aware that the longer the gas line, the more pressure you lose. And in many cases you cannot afford to lose pressure. Also, the longer the gas line, the more expensive the installation will be. Of course you do have the option of digging the trench yourself. In fact, you can do the entire installation if you are well instructed and gather enough information on pipe and gas lines.

By law you must have the area where you will dig checked for existing underground utilities. Call 811 to start the process. (For more information go to www.call811.com.)

Though many potters prefer underground piping for the gas line, others feel it is easier to maintain and check leaks on an above-ground line.

Some questions that may arise are: Do I need to get a higher capacity meter? Do I need a separate gas system? This is a big decision, for when the second meter goes in, it usually means you will be billed a commercial rate for your gas. This could increase your costs dramatically. In most cases, for a home kiln, it is wise to use what you have and avoid having the gas company insist that you have a commercial line installed. This issue will come up, so be prepared for it. Each gas company has a different policy. If your local gas company installs the new gas line, they will determine if you need a separate meter. If you decide to add your own gas line, it can be tapped into the present system.

Gas Meter Tips by Halldor Hjalmarson

How can I tell if my existing meter is large enough to run a kiln?

Gas meters are sized by how many cubic feet of gas they can pass in an hour, and they are originally selected to meet the needs of the building they serve. The more original gas appliances, the larger the meter. Most household meters can pass between 225–500 cubic feet per hour. You can find the CFH (cubic feet per hour) or BTU output designation on the meter casing and/or on the dial face. The gas company may not want to put a larger meter at your home if the kiln is not in place with an appropriate label on it indicating gas requirements. They may also want to see proof that the pipeline



photo: Cindy Thompson

Look for the CFH (cubic feet per hour) or BTU designation on the meter casing or dial face. This is the pressure at the meter. The pressure is lowered for use in your house by the regulator, a valve located just outside the meter. (See a regulator on pg. 42.)

and installation have been inspected and approved.

Each cubic foot per hour equals approximately 1000 BTUs. If you have a venturi burner that is rated at 40,000 BTUs per hour, 40 cubic feet per hour from the meter is required. If you plan to have a 12-cubic-foot kiln operating with 4 venturi burners each putting out 40,000 BTUs per hour for a total of 160,000 BTUs per hour, 160 cubic feet per hour is needed (4 burners times 40,000 equals 160,000. That divided by 1000 equals 160). This assumes that no other gas appliances are used at the time the kiln is at its peak fuel usage. Some potters who operate their kilns on household volume will not use their furnace or stove during advanced stages of firing.

Can I increase the volume of gas passing through my existing meter?

While most meters may actually pass approximately 10–15% more gas than they indicate, another slight increase may be achieved by increasing the pressure. While the pressure on the main line coming to the meter is measured in pounds, the regulator next to the meter reduces that pressure to approximately 7 water column inches, or $\frac{1}{4}$ pound of pressure. Household appliances such as stoves, furnaces and water heaters are often rated for up to 14 water column inches or $\frac{1}{2}$ psi.

A gas company employee might help you increase your existing household pressure a slight bit above 7 water column inches by removing a screw cap on the regulator and exposing a screw head that may be turned to increase pressure. If the kiln is on full while they are doing this, one

can hear an increase in the volume and pressure. The employee can also put a gauge on the regulator to indicate the pressure increase.

How do I select the correct size and type of pipe for the kiln?

The size of pipe connecting the kiln to the meter depends on the cubic feet per hour needed for all the burners and the length of the pipe. The longer the pipe, the larger it may need to be.

In general, a 1" pipe may be suitable for a 12-cubic-foot soft brick kiln, and a 2" pipe for a 40-cubic-foot kiln.

Galvanized pipe or "black pipe" are both suitable for above ground installation, but a coated pipe may be required for below ground. If a pipe is installed below ground, all connections and bare pipe have to be protected by a coating, and the pipe has to be buried deep enough to protect it from moisture and accidental tampering.

Building codes differ from location to location and one should check on requirements before installing underground pipes.

If a kiln can be positioned where all piping runs above ground, a lot of grief will be avoided. Sometimes the piping can be run overhead to prevent obstructing the walking paths around the kiln.

STEP 4**Build the Kiln Foundation**

Concrete block (or cinder block as some call it) makes a perfect, very flexible foundation for a kiln. You can flex the size to fit the kiln footprint, and of course you can build it to any height that suits you.

Leaving small gaps between the concrete blocks is important; this helps disperse the heat so the blocks will not get too hot. (The gaps can be up to around two inches.) This will allow a clean flow of air beneath the kiln. Concrete can deteriorate and even explode if heated to too high a temperature.

There has been a great deal of discussion on what system of stacking is best and how the blocks should be stacked for the best load bearing. Frankly, getting the floor of the kiln to center on your waist (or just a bit below) is the most important aspect of the foundation.

Add a Base Layer of Expanded Metal

There is always airflow through the cracks in the roof and four sides of any kiln. The kiln must breathe. There is no reason to block off the bottom of the kiln. **Do not put a solid base on top of the block to start the floor.** Use perforated metal; in industry it is called “expanded metal.” Expanded metal solves a very old construction problem: getting the base flat and covering the concrete block foundation. The advantages are huge. It is solid and flat, it will not burn or deform, and it lifts the entire kiln off the concrete blocks to allow air to enter the bottom of the kiln. Now the kiln breathes on all its faces.

Finding fireproof hard and solid surfaces is difficult. Some potters use dura board, and/or



photo: Bill Burgert

Use cinder block to raise the floor to the right height.

other concrete-based sheet material. Look for “tile backer board,” “concrete board” or brand names such as Durock Cement Board or HardieBacker Cement Board; but expanded metal has them all beat, hands down.

Check with any welder, metal and iron vendor, or home building supplier to purchase it. The heavy-duty $\frac{1}{4}$ ” metal works best.



photo: Mel Jacobson

Expanded metal is the ideal base layer.

STEP 5 Gather the Basic Materials for Building Your Kiln by Tim Frederich

There are many different types of materials available for building a kiln. The materials discussed in this article are directed toward the construction of permanent kilns—those kilns that probably will not be moved during the lifetime of the kiln.

These are kilns used by studio potters, ceramic artists and ceramic programs in schools or other institutions. These kilns can be of variable size and shape and fired with different types of fuel (wood, gas, oil etc.) and different atmospheres such as salt and soda.

Brick

Brick is the most common material used in kiln construction. It is used in the basic electric kiln, the small gas-fired studio kiln, large wood-fired kilns, and mammoth industrial tunnel kilns. There are two basic types of brick used in building kilns. One is the lightweight insulating brick (commonly known as IFB), and the other is a heavier hard brick. Most brick (both insulating and hard) is available in either a 2½"- or a 3"-thick series. The series will contain many different sizes and shapes including arches and wedges for constructing kilns of varying dimensions.

Insulating Firebrick (IFB)

Insulating firebrick does exactly what the name implies. It acts as an insulator, allowing only a small amount of heat to penetrate the surface of the brick and reflecting the heat back into the interior of the kiln. The brick is made of refractory materials and formed by a process which allows numerous small pockets of air to be



photo: Mel Jacobson

Insulating firebrick is very lightweight and easy to cut.

incorporated into the brick—allowing the insulating quality (with less heat storage) but maintaining the structure for strength.

Insulating firebrick are soft compared to hard brick and can be cut with a small hand saw. (It will take the teeth off the blade over time.) It can be easily ground to shape to fit specific areas. IFBs will heat rapidly and cool faster. They act as an excellent backup to hard brick in the kiln construction process. They are, however, susceptible to atmospheric vapors and do not perform well in wood, salt or soda kilns. Since they do not store heat, and cool quickly, they might not be the proper choice in certain situations.

Insulating firebrick are manufactured in many temperature ranges, but the most common are: 2300°F (1260°C); 2600°F (1427°C); 2800°F (1538°C); and 3000°F (1649°C). Most of us would use the two lower temperature IFBs. As the working temperature of the brick increases, more heat penetration occurs, and the insulating value will drop. Most insulating brick are accurate in size, due to the fact that they are cut or ground to their dimensions after being fired during the manufacturing process.

Hard Firebrick

Hard firebrick has been and still is the “work horse” refractory, serving all types of industries. It is an efficient and economic product that provides lasting service. There are many types of hard firebrick manufactured throughout the world, using either the wet mud or dry pressed process. Almost all hard firebrick begin with a fireclay and the addition of other minerals (feldspars, alumina, bentonite, etc.) to form a wet body used in the making of the brick.



Hard brick absorbs more heat than insulating firebrick.

The wet mud process requires the mixing of a really wet clay body that can be pressed or squeezed into a mold to form the brick with the minimum amount of pressure, even allowing it to be done by hand. The brick has to be dried for a period of time before it can be handled or loaded onto kiln cars to be fired.

Dry-pressed brick are made using a clay body with a very low moisture content (possibly 8–9 percent) in a large press (usually hydraulic) under a tremendous amount of pressure. When the brick comes out of the press, it is dry enough to be handled and loaded onto kiln cars to go to the dryer and into the kiln. Dry-pressed

brick have a high degree of strength and are very dense.

There are four basic types of hard brick: low duty, medium duty, high-heat duty and super duty. The low duty and medium duty are usually used as backup brick in most kiln construction unless you are firing to low temperatures (2100°F and lower).

High-heat duty and super-duty brick are used for most high temperature kilns (2100°F and higher). They are abrasion and spall resistant and withstand rapid temperature changes in the heating and cooling of the kiln.

Many of the brick manufactured today do not have identifying marks, so it is easy to mix them up if you purchase different grades. It is recommended that you buy one type and use it for your kiln. Although it might cost a little more in the building of the kiln, the super-duty brick are the best value and will provide the best service throughout the life of the kiln. There are many instances when these bricks have been used again in other kilns. They provide an excellent surface for wood and salt/soda kiln atmospheres.

Hard firebrick do absorb more heat into the body of the brick compared to insulating brick. This may add to the initial fuel cost of the firing, but the advantages can override the extra fuel expense. It may take less fuel to hold the kiln at higher temperatures and will allow the kiln to cool at a slower rate. This can contribute to better glaze surfaces and color development in atmospheric firing conditions.

Mortar

There are many brand name mortars available. It is recommended that you use any air-drying mortar that is rated to 3000°F (1657°C). If the kiln is not meant to be a permanent structure, you may not want to use a lot of mortar. If you are planning to use the kiln for many years to come, then use a very thin coat of mortar between all of the joints. This will keep the movement of the brick to a minimum, due to the expansion and contraction of the kiln during the firing. It also helps to prevent outside air from entering the kiln. The outside air can lengthen the firing time and increase the fuel cost. It is also important to mortar the joints in the chimney so they will not affect the draft of the kiln.

Ceramic Fiber

Ceramic fiber (a common brand is Kaowool™) is manufactured by fusing raw materials at high temperatures. The molten materials are turned into small droplets, using forced air to stretch the droplets into fibers. These fibers overlap as they are collected on a screen, thus forming a mat or blanket. To form ceramic fiberboard or paper, pressure is applied to the fiber mass, creating a dense, hard product. These fibers can also be made into ropes, braids, cloth, and many other products. They can even be vacuum-formed into custom shapes according to customer specifications.

Ceramic fiber products work according to the same principles as insulating firebrick. A large number of small air pockets are trapped between the fibers as they are layered on top of each other. These air pockets act as an insulator when high temperature is applied to the surface.

Ceramic fiber products are lightweight, do not store heat and have excellent thermal shock resistance.



photo: Pat Lindemann

Ceramic fiber is easily cut and formed.

The fiber product most used in kiln construction is ceramic fiber blanket. The blanket can be easily cut, formed into shape, and either glued or pinned into place. Many of the newer industrial kilns are using a blanket folded in a Z-shaped formation and then pressed into a solid shape for the walls and ceiling of the kiln chamber.

When working with ceramic fiber blanket or other product, use the proper respiratory equipment. The dust from the fiber can collect in your lungs and cause respiratory problems.

When planning to use ceramic fiber blanket, there are several points to be taken into consideration. The first point would be the temperature range to which the fiber will be exposed. Fiber blanket has different temperature ratings, with 2300°F (1260°C) being the

most common and the one most used in kiln construction. Higher and lower temperature blankets are available.



photo: Mel Jacobson

Use a respirator when you cut ceramic blanket.

The second point is the density of the blanket (4#, 6#, 8#, 12#, etc.). The higher the density becomes, the better the insulation value. The most common densities found in kilns are 6# and 8#. Cost can become an important factor when using the 12# and higher density.

The final consideration is the thickness of the blanket. The thickness of the blanket, along with the density, determines the insulation value. Ceramic fiber blanket is available in many different thicknesses, but the most common sizes for use in kiln construction would range from ¼" to 2". As an example, a 1" blanket might be attached to the brick walls or placed over the arch of the kiln for extra insulation. It might also be folded and used to form solid blocks for commercially produced fiber kiln modules. Two-inch blanket might be wired to a mesh shape to form a raku kiln and the cover. Some electric kilns have a layer of blanket between the brick and outer metal shell.

Castables

Castable refractories are widely used in industrial situations such as steel plants, power plants, brick plants and more. They are used to line the interiors of ladles, furnaces, boilers and kilns. Many of the kiln cars used in brick plants have a layer of dense castable and a layer of insulating castable cast on the car frame before the refractory setting block are placed to form the floor of the kiln car. Castable refractory is used in the construction of large industrial kilns because of the ease of application, ease of maintenance and better combustion efficiency, as there are almost no joints in the ceiling and walls.



photo: Andy Kazukewicz

Castable refractories can be troweled as well as cast.

Castable refractories can be applied by many methods including casting, troweling, tamping and pneumatic gunning. The secret to using a castable is the proper water ratio and appropriate curing time. The average tendency is to over-wet the castable to make it flow more easily, but this can result in excessive shrinkage and a loss of strength. Most castables are air-setting, but may need to be kept damp during the curing phase. This can be done by misting

with water and covering with a damp cloth and/or plastic sheeting. Castable may require a little time and labor in learning to use the product, but may be well worth the effort. It can be a great material for arches, flues and burner ports.

There are hundreds of commercial castables available under different brand names, and they are divided into several categories depending upon the intended use of the product. These categories are then further sub-categorized by temperature, strength, density, and insulation quality. When purchasing a commercial castable, talk to a representative of the product, explain your use and let them recommend the proper castable. Commercial castables can be expensive, but well worth it for certain applications where strength and temperature values are a requirement. There are good homemade castable formulas in ceramic books and magazines that may work fine as an insulated coating for the outside of the kiln.

As you can gather from the information above, there are a variety of materials available that can be used in the construction of a kiln. Prior planning will contribute to the successful completion of your kiln project.

Tim Frederich was a Product Support Specialist for the Orton Ceramic Foundation, a former editor of Pottery Making Illustrated and associate editor of Ceramics Monthly. He now is associated with Diversified Ceramic Services, Inc. providing refractory and mineral products to the ceramic industry. Tim has a B.F.A. in Ceramics from Ohio State University and has been a potter for over 40 years.

Other Useful Materials

Some other useful materials to have on hand are:

Spiral Pipe

Spiral pipe is produced for the heating and air conditioning industry. It has replaced the old crimped pipe systems used in the past. You can see spiral pipe in most open ceilings in malls or buildings. It is usually painted to match the décor. In the south it is often used for culverts. It is ideal for home kiln stacks. It can be found either at local sheet metal companies and sometimes in building supply stores.

Spiral pipe can be purchased in any length, radius, and gauge.



photo: Mel Jacobson

Spiral pipe is ideal for home stacks.

ITC (International Technical Ceramics) Coating

ITC is a reflective thermal coating that will protect your kiln and make it last much longer. ITC thermal coatings work. They are not a panacea, but they can save you a great deal of energy. We recommend using them mainly on IFBs and Kaowool. (It would be counter productive to use this coating on hard brick.)

ITC has many uses. If you coat the outside of Kaowool blanket with it, you won't have to breathe in the Kaowool's loose fibers. You can also use ITC to coat the ends of thermocouples and the leads of wiring from pyrometers. Using ITC on the inside of an electric kiln will triple the life of the kiln and coils.

The product has been controversial, and some folks believe it cannot work, but many potters have used it for years with wonderful results. ITC is available at Axner Pottery Supply.

Fire Retardant Paint

There are several "fire retardant paints." They can be ordered from any quality paint store. They are basically latex paint that is filled with small bits of kaowool fiber. They work well on wooden or sheetrock walls as well as 2x4s and roof supports. This coating will allow a wall to reach about 500 degrees before ignition. It does not stop fire, but it slows it down a great deal, and helps keep a warm wall from combusting.

STEP 6 Build the Kiln Floor and Walls

The Floor

There is a great deal of myth about kiln floors. Some folks think that since heat rises, you don't need to add insulation to the floor. Wrong. A great deal of heat escapes from the floor, so it is imperative to add at least one layer of insulating firebrick in the floor system.

Starting on top of the base of expanded metal, place a clean layer of hard brick, being fussy to make it flat and tight. Do not add sand to fill the cracks. If possible, use new, heavy-duty hard firebrick. Butt each brick tight to the next.

Work out a pattern so that the 9" brick will work out to a perfect fit. Many builders use a solid herringbone pattern for strength.

Find a pattern and reverse it for the second layer. At this next stage it is wise to use IFBs. This is the time to piece in all the broken brick and cut everything to fit tight. Again, keep things tight and flat.

The third layer should be another layer of hard brick. Double check for square and run a tape across from corner to corner to make sure all is perfect. Remember, fussing at the start will mean you won't have to take it down and start again.

The Walls

Before you start your kiln walls, mark on the floor with chalk or crayon where the door will be, and mark out the flue and burner ports. Make sure you "lock in" the chimney stack by overlapping brick between the walls and the stack. You do not want the chimney section to pull away from the kiln after 20 firings. The lock-in is essential. Regarding mortar, you will not need to apply mortar to the walls, but you should apply mortar to your chimney to create a better draft.

Plan for Spy Holes

As you are building, decide where the spy holes are located and build them in as you go. Make a place to insert your pyrometer, and make sure you add a couple other places that may come in handy later. These holes can be filled with Kaowool now and easily opened later.

Drilling through IFB is easy, and the best way to do it is to find a copper tube about a half inch (or slightly less) in diameter. Insert the tube

into a drill motor and use it as a drill bit. It makes very clean, well-made holes.

If you have gaps or cracks, Kaowool can be stuffed into them as you build the kiln. Kaowool can also be soaked with wet mortar or ITC and stuffed into cracks.

About Kiln Doors

Though some potters will design elaborate metal and brick hinged doors, in most cases, the door bricks can be stacked by hand. This a very simple, quick method that should take just minutes to do.

Many potters mark their door bricks with a marker, so they can stack them in the same order each time. Making sure the base of the door is clean, flat, and without gaps helps the door go in perfectly each time.

Mel has some flat-top door stacking tips in Chapter 3 and Vince Pitelka explains how to stack a door in an arch-top kiln in Chapter 5.

About Bag Walls

Bag walls are basically heat dams that stop the flow of heat and flame. A standard gas kiln does not need a bag wall. There are, however, some unique designs such as wood-fired kilns, where the bag wall is essential to protect the ware and move the fire to the back of the kiln.



photo: Donovan Palmquist

First layer of hard brick. Note the expanded metal base.



photo: Donovan Palmquist

Find a pattern and reverse it for the second layer.



photo: Mel Jacobson

Copper tubing makes a great IFB drill bit.

STEP 7**Build the Chimney**

Every kiln needs a system of moving heat and air. This system is made up of a few basic parts:

The Flue

This is the hole or outlet to the chimney stack from the inside of your kiln.

The Chimney Stack

This is the brick support system for the smokestack and the damper.

The Damper

This controls reduction by cutting off air in the chimney and it closes off the chimney when the kiln is done firing.

The Smokestack

This is the metal pipe that allows gases and smoke to be released into the air.

For proper firing, it is essential that all these parts of the systems work together properly. Good potters do not fire their gas kilns with any visible smoke. If you have smoke coming from the smokestack it means your fuel is not being burned with enough oxygen. **No smoke or flame should ever come from a gas kiln.** Smoking kilns waste fuel; it's bad for the environment, and it costs money.

Kiln Style and Draft

There are several styles of kiln based on how the flue and chimney are designed.

The most common stoneware kiln built is “down-draft.” The flue is at the bottom of the kiln with a channel to the chimney. This type of kiln is easy to reduce, and quit simple in design. It is a potter’s kiln.

Up-draft kilns have their flue in the center of the



Bill Burgert's stack and damper.

top of the kiln. Often a chimney is not needed, just a hood over the kiln to move the gases and smoke up a stack. Industrial kilns have historically been up-draft style. They are simple to fire, can be placed inside a building and are easy to hood and vent. Many up-draft kilns are fired with a neutral or oxidized atmosphere. By sliding a kiln shelf over the flue opening a reduction atmosphere can be attained.

Many up-draft kilns have their burners beneath the kiln—often four or more burners in a manifold system. The kiln is encased in metal, with strong metal legs placing the kiln far above the floor. There are many commercial up-draft kilns available. They are often referred to as “heat furnaces.”

A cross-draft system is much as it sounds. The burners are placed at opposite sides of the kiln and heat crosses the kiln, mixes, and then rises through the work and back down to the flue. This system offers a lot of flexibility in the placement of the burners and the orientation of the kiln. It is a common and well-used system.

In all of these systems the heat work should be the same. A great glaze should melt in any of them.

The Flue

The size of the flue is critical. Far too many kilns have flues that are 81 square inches or larger. The heat just escapes.

In his plan for the flat-top kiln, Nils Lou suggests a flue of no larger than 40 square inches. (He maintains it does not matter how big the kiln, the flue size is the same.) Other professional kiln builders will suggest a flue size of 5" x 9", or 45 square inches. Donovan Palmquist says, "I tend to agree that large flues in most kilns are not necessary. For the past 15 years most of the flues I build in gas kilns are 5" x 9". It seems that the 5" x 9" is ideal.

This tends to make pressurizing the kiln easy and they fire very evenly. I use the damper to control the rate of flow through the kiln and for reduction fine tuning."

Wood-fired kilns, of course, must have larger flues to allow the proper air to flow through the kiln. That is a far different issue.

The Chimney Stack

The chimney stack must be tight and mortared in place. The stack cannot have air leaks. It is suggested that the chimney stack be made of new hard brick. It, too, must be level and ready to accept the metal smokestack. Wherever possible, the chimney stack bricks should be tied into the body of the kiln.

Mel says, "On several occasions I have been asked to survey or help correct a malfunctioning kiln where the chimney became the main culprit. The potter had free-stacked old brick that were full of mortar. The air gaps in the chimney were in the inch range, not fractions of inches. It was like the entire chimney was a

passive damper. The kiln was very well built, it was done to spec, but the chimney was a disaster. It did not function at all. I had the potter take the entire chimney down. He just did not understand that a bad chimney will not draw, but does just the opposite. We mortared a new firebox, and then built a straight and clean chimney with mortar and new hard brick. We made the new one two feet shorter, and the kiln fired like a dream. We took five hours off the firing time and saved about 50 gallons of propane (at \$1.98 a gallon). That was a huge saving of both time and money. One design flaw made for a bad kiln."

Reduction vs. Oxidation

Reduction is the term for restricting the amount of oxygen that is allowed into the kiln during firing. It is often done at around 1700°F by slowly pushing in the damper and also cutting the primary air to the burners. Or, you can leave the damper in place and increase the gas pressure.

Most potters find that a combination of increasing the gas pressure, pushing the damper in a bit, and fractionally closing the primary air is best. During reduction the pressure will increase and a small flame will come from the spy holes. The length of the flames should be kept at about 3–4 inches.

Oxidized firing means the kiln has ample oxygen at all times. The damper is wide open, there is ample air to the burners, and the pressure of gas is constant. You'll learn more about the effects of oxidation and reduction in the chapter on firing.

Building a Castable Chimney

Another option is to create a chimney out of castable materials. (You can find the complete instructions on this in Chapter 9.)

David Hendley has this to say: *I found that a castable refractory chimney has some desirable characteristics compared to other types of chimneys. The heavy mass of the stack, compared to a ceramic fiber sleeve, helps, I think, to induce a good lively draft through the kiln in the early stages of the firing. An advantage over a brick chimney is that the castable stack is airtight. Brick chimneys can develop cracks that serve to slow down the flame draft through the kiln, causing unintended reduction.*



photo: David & Karen Hendley

Learn how to build David Hendley's castable refractory stack in Chapter 9.

The Damper

The damper is critical to controlling reduction of oxygen in the kiln and it closes off the chimney when the kiln is done firing.

In most types of kiln the damper fits in a slot left in the chimney stack. In an updraft kiln a hole is left in the top center of the kiln to exhaust the smoke and fumes. A piece of broken kiln shelf is often used as a damper.

The damper can be made from old kiln shelves, heavy metal or a piece of ½" ceramic fiber board. (This is the best option.) Proper care of the damper is important. Most potters leave the damper in place when the kiln is not being used.

It is important to remove the damper from its slot just before you turn on your kiln. Insert a gas torch and heat the stack from the damper slot upwards. This heating will allow the kiln heat to rise up the chimney and start the process of firing.

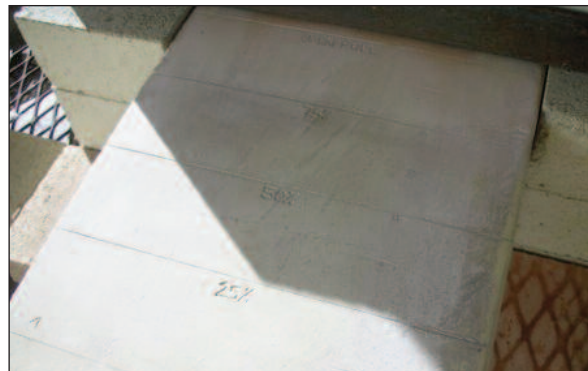

photo: Bill Burgert

A conventional damper.

Kurt Wild says:

I have been using the HD “M” board as my damper and love it. Depending on the manufacturer, it is generically called Ceramic Fiber Board, but more specifically “M” board or Dura board). Either board comes standard or as hard board. Either standard or hard comes 2' x 4' x 1”.

Passive Dampers by David Hendley

A passive damper is nothing more than a hole in the kiln stack. All that is needed to make a workable passive damper is a way to vary the size of the opening. This can be simply done by blocking off part of the opening with pieces of bricks or kiln shelves. My passive damper does a great job of controlling the draft in my kiln. I wonder why more potters don't use passive dampers in their downdraft kilns. The principle of the passive damper is simple: If there is an opening in the chimney, cool outside air will be drawn into the chimney through the opening. This means that less air from inside the kiln will be drawn into the chimney, thus slowing the flame and heat movement through the kiln. A kiln can have, and many wood-fired kilns do, both a regular active damper and a passive damper.

When I got my commercial chimney sections, the damper was a fancy butterfly valve that could be adjusted by changing the weight of the counter-balance. I think its purpose was to regulate the temperature of an incinerator, so it would burn efficiently but not too hot. It was not ideal for a pottery kiln, so I modified it by welding a flat steel plate with a 10” diameter hole over the opening. Rails on the steel plate

allow a heavy steel door to be adjusted to cover the hole or allow it to be partially open.

A big advantage of the passive damper is that it doesn't wear out. A conventional damper works by blocking off part the stack to slow the draft, which requires that something like a kiln shelf or a thick piece of steel be put directly in the flame path. This is a very harsh environment, which can lead to deterioration of the damper.

One drawback of this style of damper is that the chimney cannot be sealed off to promote slow cooling at the conclusion of a firing. After a firing, I seal the chimney by climbing a ladder to the kiln-shed roof and placing a kiln shelf on top of the chimney.



photo: Karen Hendley

This damper is a heavy steel plate that slides in angle iron tracks. It allows infinite control of how much outside air is allowed into the stack, as well as a positive seal during the cooling of the kiln.

Install the Smokestack

Smokestacks are usually made of metal pipe. Spiral pipe is an excellent choice for a smokestack. It comes in all sizes and dimensions. It can be made special for you, or you can find scrap pieces that may fit your needs perfectly. It comes in any gauge and does not have joint systems. It is one piece.

Smokestack height is determined by your roof system and is usually in the twelve-foot range. Most smokestacks have diameters of 10–12 inches.

Lining the Smokestack

The spiral pipe lined with fiber sleeves has become the state of the art for smokestacks. Ceramic fiber liners can be ordered to fit the pipe perfectly.

If you can soak your fiber liners in ITC 100 you will triple their life. When dipped in the ITC 100, the liners get a bit wet and sloppy. Then when they are dropped into the pipe they mesh together to make a completely tight, one-piece liner that perfectly fits the spiral pipe casing.

Without the ITC coating, tiny breaks and poor fitting of the liners can create gaps that allow the heat to play against the bare metal pipe. This can cause a hole to be burned right through the metal pipe.

Lay a thin gasket made from ceramic fiber on the flue opening of the chimney stack for the metal pipe to rest on. This will keep the air from leaking in or out.



photo: Mel Jacobson

Ceramic fiber liners can be ordered to perfectly fit your spiral pipe smokestack.

STEP 8 **Secure the Structure Metalwork and Welding**

One of the big headaches in kiln construction is the fear of welding or of bringing welding equipment onto the kiln site. Welding is the ideal system for getting your kiln buttoned up and stable. If you can weld and have the equipment, you are on the way.

For those that do not want to weld, there are other options available. Kurt Wild and Bob Fritz use angle iron with a hole drilled in it. They place an eyebolt through the hole and pull it tight with a cable attached with cable clamps.

Aircraft cable and turnbuckles work very well too. Place angle iron on the four corners of the kiln then wrap the aircraft cable around the kiln and cable clamp it to a large turnbuckle. Pull the slack out of the cable and tighten both ends of the cables to the turnbuckle. Use a small wrench to pull the turnbuckle up tight.



photo: Mel Jacobson

Mel's kiln with cable and turnbuckles. They have been in place for 40 years.

Don't try and save a penny on cheap framing. Always use strong, well-made, new angle iron for your kiln. Avoid the temptation of using old cheap angle iron that is bent and falling apart.

Please—no bed frames! The kiln frame stabilizes the kiln and holds everything in place. A well-made frame will last a lifetime. It will be well worth your money to hire a welder to build your frame.



photo: Bill Burgert

Bill Burgert uses an angle-iron clamping system.

It works very well to have a simple angle brace on the bottom of each leg of your frame. Drill a hole through it and into the concrete floor. Buy some metal wedge bolts (ask your hardware store owner) and bolt the leg to the floor.

STEP 9 Raise the Roof

By this time, you should have made some serious decisions about the roof you are going to add to your kiln.

You now know the two most common systems are flat-top and arch-top. Either system will work just fine for firing pots. But keep in mind that of the two, the flat-top is the easiest and the least expensive.

The “Small Flat-Tops” chapter has an excellent roof plan. Bill Burgert, Bob Anderson, and Kurt Wild have all made great kilns with this roof style. And Bill Merrill adds an ingenious solution to roof building with his suspended flat-top plan.

Arch roofs are gorgeous to look at and have a wonderful historic presence, but are much more complex and expensive. Donovan Palmquist takes the mystery out of building them in Chapter Four. Follow his plan to create your own beautiful arch.

Movable or lift roofs must be planned with great care and require strong overhead support members. In Chapter 6 Michael Wendt offers some tips and tricks to building this style of kiln.

Be very conservative when it comes to building your roof. Use new brick, strong bracing, and quality welding and bolt systems to hold the entire roof in place. Using used or rubble brick can lead to many problems. Rubble brick makes great insulation, but is a poor construction material.

To increase the safety of your kiln add a blanket of ceramic fiber over the top. It is by



photo: Colleen Reilly

Donovan Palmquist will show you how to build the perfect arch in Chapter 4.

far the best cover for a kiln. If a roof brick should come loose and fall into the kiln, no heat or flame will come through the fiber blanket. It's very cheap fire protection.

Potters have invented a great many roof systems. Some have support from above, some have cables and metal trusses, some have rods of metal through the brick and bolts on the end. Whatever roof style you select, plan ahead, get good materials and understand that the roof is the most critical aspect of your box construction. Do it well.

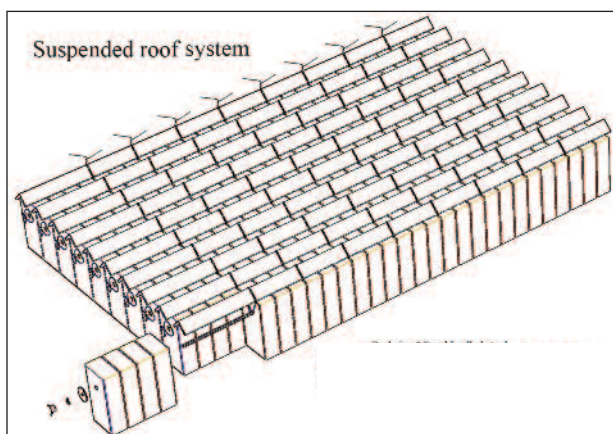

illustration: Bill Merrill

Check out Bill Merrill's suspended roof plan in Chapter 3.

STEP 10 **Install the Burners and Regulators**

If you are building a small backyard flat-top kiln you do not need huge burners. If you are using propane you will have all the power you need, as propane provides many more BTUs per unit than natural gas (about two-and-a-half times more). A pair of natural air/venturi burners will work very well.

As the size of your kiln increases, the amount of gas you need increases. A large car kiln for big-scale production would benefit from electric power burners, with a system to inject forced air into the gas.

It is always a toss-up to recommend one system over the other. Here are some basic questions you need to answer first:

- How many cubic feet do you need to heat?
- What cone do you want to fire to?
- Are you using propane or natural gas?
- What gas pressure is available to you?
- Do you need compressed air in your burner?
- Do you have electric power at your kiln site?
- How much do you want to spend?

Price rules burners. There are many commercial burners on the market. They all work well. Ransome, Johnson, Marc Ward, and Nils Lou brands are all good.

Look in the back of *Ceramics Monthly* magazine—there are dozens of ads for burners.

Without question, you want the best burners that money can buy, especially if you are in this for the long term. Getting quality advice and buying quality burners will serve you for your entire life.

The Simplest Burner

You can make your own burners. In fact most of the parts of a simple burner can be found at your local hardware store

The experience of making your own kiln and making your own burners will always serve you. It is knowledge gained and part of being a total potter. But, in the end, well-made commercial burners are a delight and worth the money spent.



A simple homemade burner.

photo: Mel Jacobson

Venturi Burners

Simple venturi burners work with gas and air only. There is no additional electricity used for blowing air into the burner.



photo: Mel Jacobson

This Ransome venturi burner is perfect for home kilns.

Gas enters the burner through a hole called the orifice (or jet). The size of the hole regulates the amount of gas that passes through it.

Be aware that the orifices used for propane and natural gas are not interchangeable. Propane has more BTUs per unit and is delivered at a greater pressure through a smaller orifice than natural gas.

It is important that you order a burner with the appropriate size orifice. Make sure you know what type of fuel you are using, how much pressure you have, and the BTUs you need to properly fire your ware. Your burner supplier will guide you to the correct choice.

Venturi burners usually come from the factory with a pre-determined orifice size and around a 500,000 BTU rating.



photo: Mel Jacobson

Nils Lou burners firing the salt kiln at Mel's farm. These same burners can be used on the wood-fired kiln in case it stalls or we run into harsh weather.

Cleaning Used Burners

If you come across used burners, you must make sure the orifices are clean and of the proper size. In most cases the size of the orifice is the same size as a standard drill bit, so it is easy to re-drill the hole to clean it and make it round again. If you can determine the burner manufacturer's name, call them, get the factory specs, and re-drill the orifice to that size.

Changing the Orifice Size

You can change the orifice size on your burners if you need to. Many companies sell a variety of low-cost orifices. For example, if you change from propane to natural gas, you can simply buy larger natural gas orifices for your burner system.

You can also get more gas to your kiln by drilling the existing orifice larger, but it is not wise not to do this on a whim. Before drilling, check with your burner manufacturer and consider other options first, like increasing the gas pressure. Once an orifice has been drilled, it cannot be made smaller.

If you do re-drill your orifices, make sure you do it in very small steps. Drill, test, and fire. Large changes can be difficult to correct.

Nils Lou Burners

Nils' burners are standard venturi-type burners. The best feature is that they allow in a massive amount of primary air. In burner parlance, they are extremely efficient.

Mel says: *The Nils Lou fully-open primary air burners work very well at our farm. The burner fires faster and with more power than any other burner we have used. The unlimited primary air working with the three angled orifices provides amazing performance. We use high pressure welding hose with about 25 lbs. of gas pressure, from a buried standpipe with a quick connect system that allows us to move burners from kiln to kiln. We use homemade burners and weed burners and rotate them from kiln to kiln as needed.*

Power Burners

A small flat-top home kiln will fire very well with a natural draft air burner system. In fact, it may be overkill to build in a compressed air system. But, if you are going to do full-time commercial work, it is in your best interest to think of a blower-driven/compressed-air burner system for the kiln. This assumes that the kiln will be in the 40-cubic-foot range or much larger. Power burners work well. The only drawback is that they do not work without constant electrical power at the kiln. If you lose the power, your kiln shuts down.



Tom Wirt and Betsy Price run Mark Ward power burners with power-out solenoids and thermocouples.

Power Burners by Donovan Palmquist

When I design a kiln I am building a tool that can be exquisitely controlled to give the person that is firing it the work they are after.

I use Johnson Burners because they are somewhat bulletproof and will last a lifetime. I am required by my liability insurance to install safety systems on the kilns I build and the Johnson system is quite safe and reliable.

I have installed Ward burners, Ransome burners and Eclipse Burners. They all work and all have their drawbacks. Lately, with fuel concerns a big issue for some people, I have shied away from venturis because they are less efficient than a forced air burner and you (sometimes) have less control.

The data suggests venturis use approximately 20–30% more fuel because they operate less efficiently than power burners. If you are a person who likes to fire gas in an extreme oxidation atmosphere, venturis may not be the ticket. It can be done, but it is a little trickier.

Once you get used to power burners they can be controlled very easily and with great efficiency. As for the cost, I used to think Johnson was expensive until I started building a few on my own when Johnson was down because of the Cedar Rapids flood. When you add together the parts and time to build these you see why they cost a bit more. I have a complete shop to build them and it still takes time. Johnson builds my high limit control panels and they stand by their product 110%.

When I have installed Ransome burners on kilns where we have decided not to use power burners (no available electricity) I need much more hardware to hook them up and in many cases more burners to achieve the same result (BTUs). I also need safeties and pilots on all of those, so the cost in the end is comparable to power burners.

In the end I want a tool that will work trouble free, fire efficiently and give you the best results possible.

Install Gas Regulators & BASO Valves

The basic home regulator on the wall near your gas meter is set for household needs. It is possible that you do not need to add a second regulator, but you may have to have a plumber, or gas service person open the regulator a bit to allow more gas to flow to your kiln. In that case, small appliances in your home will have to have their pilot light systems re-set for more pressure.

However, most kiln applications will require that a higher pressure regulator be installed. Having good communication with your natural gas supply folks or your propane dealer is

critical. Most gas folks do not have a clue what temperatures a kiln fires to. They may try to sell you household regulators.

If you are using propane, it is a must to have a high-pressure regulator between your burner and the tank. The regulator keeps the gas from going backwards, so in case of fire it will not allow heat or flame to go back into the tank. It also controls the amount of gas flowing through the line to the burner. So it is both a safety valve and a flow regulator. As you learn to fire you will find a “set” place to keep your regulator. You will have to experiment with pressure to find the amount that fires with a clean blue flame and keeps the temperature of the kiln on the rise.



This natural gas regulator takes the gas coming into the house and reduces the pressure of it for use by household appliances.

Charting pressure and knowing how your kiln works under different weather and wind conditions is important. Deep, cold winter will reduce gas pressure; hot summer days will increase gas pressure. Learn to adjust to the conditions as they change.

BASO Valves

A BASO valve can be found on almost every furnace and water heater in the average home. It is the safety system that is connected to and controls the pilot system. (*BASO is an acronym for a historic switch called the Baltimore Automatic Shut Off.*) The main gas pipe goes into the BASO valve and the pilot light comes from the side of the valve. The “red button” is pushed to lift the on/off valve to the top of the body of the BASO.

The heat from the warming of the tip of a thermocouple sends a small electronic impulse system that stimulates a magnet in the top of the BASO valve. As long as the heat flows back from the thermocouple, the magnet holds the on/off valve in the “on” position. If the pilot should go out, the heat stops flowing, and the magnet releases, causing the gas to shut off. It is the most simple safety system for any kiln burner. In most cases, the BASO valve has three positions: pilot, full on, and off.

Every kiln burner should have a quality BASO valve and a clean, well-maintained pilot light system. Many new BASO valves are controlled by electronic systems using a spark plug to keep the gas ignited. Either system works very well. The old BASO valve system does not need electricity to make it work, so an outdoor kiln away from power must use this system.



photo: Reg Behrends

Reg Behrends' propane tank and regulator.



photo: Reg Behrends

Reg can regulate his propane gas pressure as it enters his car kiln.

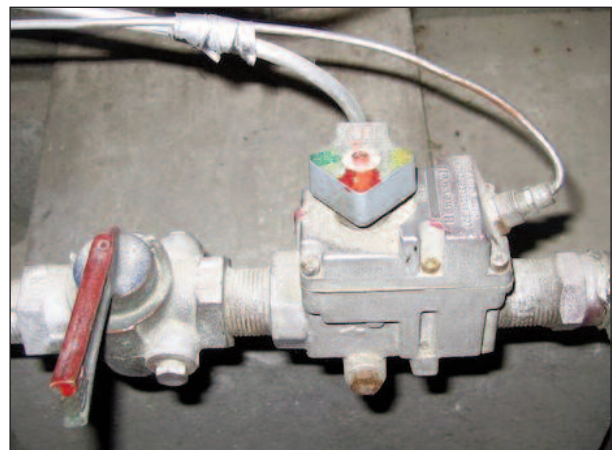

photo: Mel Jacobson

Mel's Honeywell BASO valve system.

STEP 11 **Install Thermocouples**
Selection and Use Guidelines
By Tim Frederick

More and more electric kilns are being equipped with programmable controllers. These have many advantages and can help improve fired results. However, the controller depends on thermocouples for accurate temperature measurement. This is a review of the selection and use of thermocouples for those who have a kiln with an electronic controller or those who have a fuel-fired (wood, gas, etc.) kiln.

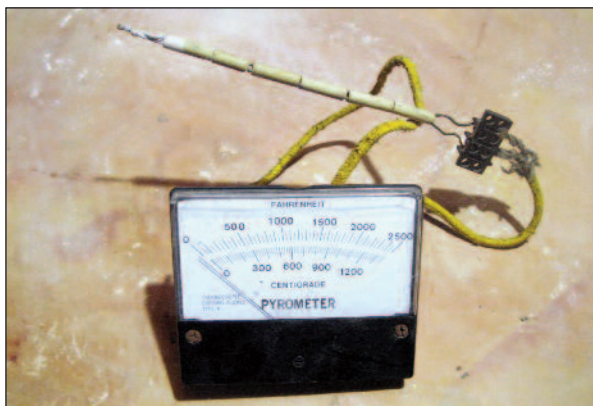

photo: Mel Jacobson

Thermocouple attached to pyrometer.

Temperature can be measured in many ways, but the most common is to use a thermocouple. Thermocouples take advantage of the findings of Seebeck (1821), who showed that a small electric current will flow in a circuit made of two dissimilar metals when their junctions are at different temperatures. When properly done, a voltage can be measured and used to determine temperature. Many types of thermocouples are available; however, only two general types are used to fire ceramics. These are Base Metal thermocouples, such as Type K, and Noble Metal (platinum) thermocouples, such as Type S or R. It is important to realize

that differences exist in the accuracy of thermocouples. At higher temperatures, readings from thermocouples can vary by more than 5°F to 20°F.

Factors Affecting Thermocouple Measurement

Many factors can affect the temperature measuring capability of thermocouples. These include:

Wire Size

This determines the durability and amount of heat pulled away from the bead. Larger wires are more durable but they frequently do not read the correct temperature due to wicking of heat away from the bead. Testing by the Orton Ceramic Foundation of a Type K (8-gauge wire) showed it to read 16°F lower than the actual temperature at Cone 06. In other words, the kiln was a half cone hotter.

Operating Temperature

The natural measurement errors increase with temperature. At Cone 6, a new Type K thermocouple can vary by $\pm 16^\circ\text{F}$ from the actual temperature. A Type S thermocouple at Cone 6 can vary by $\pm 5^\circ\text{F}$.

Protection Tubes

These are used to protect the thermocouple but they reduce how quickly the thermocouple senses temperature changes and can cause a slightly lower temperature reading (usually less than 10°F but sometimes higher). Protection tubes are recommended in fuel kilns with turbulent atmospheres. Wood ash and salt/soda vapors can cause the tips of the thermocouple to deteriorate quite rapidly and give inaccurate temperature readings or no reading at all.

Location of Thermocouple Bead or Tip

The location determines where temperature is being measured. This needs to be in a place that is representative of the actual kiln temperature. Avoid being near a heating element, burner, or peephole, and make sure the tip extends far enough (2-3 inches) into the kiln chamber.



photo: Mel Jacobson

Placement of thermocouple in kiln.

Lead Wire

A large temperature error is introduced if copper, rather than the correct compensating lead wire, is used to send the electrical signal to the electronics (Type K lead wire usually has a yellow insulated cover and Type S has a green insulated cover). Most thermocouples come with a calibrated length of the proper wire connecting the thermocouple to the meter.

Electrical Noise

Electrical fields from heating elements, relays, or other electrical noise can affect the electrical signal generated by the thermocouple and this in turn affects the temperature measured. If this problem occurs, it might be corrected by insulating the lead wires for the thermocouples.

Deterioration of Thermocouples

Either mechanical breakage or chemical deterioration can change a thermocouple. Flexing of the wire can mechanically stress it and cause breakage. Platinum is very susceptible to flexing. Chemical deterioration occurs when gases in the atmosphere or even salt from one's hands reacts with the thermocouple wire to change its composition and electrical output.

When this occurs, the temperature that is measured is different than that which occurred before the deterioration. This is called "drift." For example, Type K base metal thermocouples react with oxygen to form a ceramic coating that helps protect the metal wire. However, on repeated heating and cooling, this coating can break down and crack. In the presence of carbon monoxide, breakdown is accelerated, and the metal underneath the coating oxidizes. Oxidation reduces the wire diameter and changes its composition. Consequently, the temperature measured by the thermocouple is actually lower than the temperature in the kiln and the ware receives more heat than planned, causing some products to be over fired.

Drift of Type K thermocouples is accelerated when they are used near their maximum-rated temperature. Size of the thermocouple wire determines the temperature, as shown below:

Wire Size	Max Recommended Temperature
8 gauge (thick)	2300°F (Cone 9)
14 gauge	2000°F (Cone 01)
20 gauge	1800°F (Cone 06)
24 gauge (thin)	1600°F (Cone 011)

Since high temperatures lead to faster oxidation of the wire, a thicker wire must be used, even though more error is introduced. In one test by Orton, 8-gauge wire was oxidized almost completely through when heated at 2200°F for 300 hours. A 14-gauge thermocouple did not even last 20 firings in a kiln fired to Cone 10.

The life of a Type K thermocouple can be extended by enclosing the thermocouple inside a metal or ceramic protection tube to protect it from direct contact with the kiln atmosphere.

Type S (platinum) thermocouples provide much longer life, essentially drift-free for 1000 hours or more. Some European manufacturers use a fine 10-mil wire inside a ceramic thermocouple protection tube. Orton has used 13-mil wire with a bare bead for more than 12 years in an electric kiln and not had any problems with service life, and they use them in their gas kilns with a protection tube.

The main problem with Type S thermocouples is their initial cost, which is substantially more than the bare-bead Type K. They are also easier to break so care must be taken to avoid hitting them with shelves or pots. While some controllers can use either a Type S or Type K thermocouple, other controllers may be limited only to Type K.

Checking Controller Performance

Electronic controllers fire the kiln to a temperature (and even a cone number) based on the program selected by the user. In order to check the performance of the controller, use a witness cone located near the bead of the thermocouple. After the firing, determine if the cone has

bent properly. There should be no more than a half-cone difference.

The controller needs to be fired on a preset cone program or programmed to heat at 108°F/hour for the last hour. Temperatures at which cones bend at this heating rate are listed on the Orton Cone chart. (*You can see it at www.ortonceramic.com*) Bodies, glazes, and decoration products are formulated to be correctly fired to a cone number, bent to the 3 o'clock or 90 degree position.

Calibrate the controller until the cone bends properly. If the cone shows the kiln to be too hot, lower the temperature to which the controller is fired, if you are using your own program. If you are using a cone fire program built into the controller, you may have the option of cone offset. In many controllers this adjustment can be made permanently. If there is a significant difference, replace the thermocouple.

Useful Life

The useful life of a Type K thermocouple depends on the temperatures and atmosphere to which it is exposed. We have seen recommendations by kiln manufacturers to change out 8-gauge Type K thermocouples every 50 firings, especially when firing above Cone 1. This seems reasonable based on the drift results measured by Orton, but check your kiln with witness cones before making the change.

For lower temperature firings (below 1700°F), a Type K thermocouple is the obvious choice. We expect the life of a 14-gauge Type K thermocouple to be cut in half if used above 2000°F. If the kiln is to be used for lower temperature firings, one can expect to obtain 100

to 200 firings. Metal sheathed Type K thermocouples should last 200 firings or more.

When using Type K thermocouples in an electric kiln, it is important to make sure that carbon monoxide is removed using a downdraft vent system. This gas develops during the earlier stages of firing when organic material is burned out of the clay. If not removed, it will shorten the life of a Type K thermocouple by breaking down the protective coating.

Type S thermocouples have a much longer life and can be fired to higher temperatures. This is a plus for anyone firing to Cone 10 and above, but a protection tube is recommended.

Summary

Thermocouples are sensing devices that can be used to measure temperature. They can and do change with time and will periodically have to be replaced. Because many products today have narrow firing ranges, it is important to be sure that your thermocouple measures the correct temperature. It is always recommended that you use pyrometric cones to monitor all of your firings.

STEP 12**Select Your Shelf Type**

As explained in Chapter 1, the size of the shelves is decided at the beginning of the design process. Now it is time to decide what your shelves will be made of.

Kiln Shelf Options—The Entire Story by William “Bill” Schran

When starting the process of designing a kiln, one should consider the kiln shelves an important factor that may influence the shape and size of the structure. Several factors will have a role in shelf selection.

Kiln shelf size will play a major role in the design of the kiln. There are several standard sizes of square and rectangular shaped shelves. It's best to choose a shelf size that is readily available. One should consider the size of ware that is made, especially the diameter, and how the pots will occupy space on a shelf, including the placement of support posts. Maximum weight one can comfortably lift may be important when thinking about the type and size of the shelves.

After kiln shelf size is factored into the design of the kiln, then the type of shelf will be the next consideration. Maximum firing temperature, type of fuel and atmosphere, cost, and shelf weight all must be taken into account with shelf selection.

I shall use a standard of 12" x 24" shelf size as comparisons are made of composition, thickness, weight and cost.

Consider the K Factor—How the Shelf Conducts Heat

One factor many potters often neglect to consider is the amount of energy it takes to heat the pots and the kiln furniture. Often more energy is spent heating the furniture than the pots. We must think about the thermal conductivity of the kiln shelves, also referred to as the K factor. This is explained as the coefficient of thermal conductivity, which is the amount of heat that passes through a unit cube of material in a given time when the difference in temperature across the cube is one degree.

Simply put, different materials will conduct heat at different rates. The lower the number designation, the more insulating the material is and thus, more energy is required to heat the shelf to a given temperature.

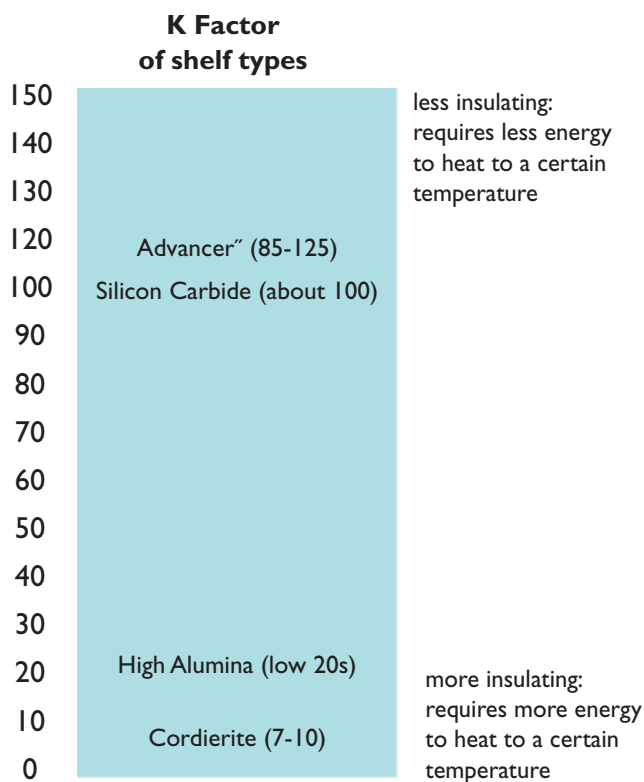

Cordierite has a K factor 7–10. High alumina shelves are somewhat higher, in the low 20's, while silicon carbide shelves have a number about 100. Silicon carbide nitride bonded shelves are similar to oxide-bonded shelves. Advancer shelves have a K factor between 85–125, depending on the temperature.

What does this mean for the potter? It takes considerably more time and energy to heat a cordierite than a silicon carbide shelf. For larger ware, especially larger diameter plates, a faster firing may result in more uneven heating between areas of the pot in contact with the shelf and the upper edge of the pot leading to possible cracking on shelves composed of material with lower thermal conductivity. Once heated, shelves with lower K factor numbers will have a tendency to hold the heat longer, which may be an advantage in slowing the cooling of the kiln.

During this research, each manufacturer or reseller was contacted and asked many questions about the refractories they provide. One question that resulted in unanimous response was: "Should your shelf be rotated (flipped)?" With the only exception being the Advancer shelf, all responded yes, shelves should be rotated. Due to the number of variable conditions shelves may be subjected to, no specific routine for rotating was suggested. Potters should pay attention and be aware that cordierite is more susceptible to warping than silicon carbide shelves.

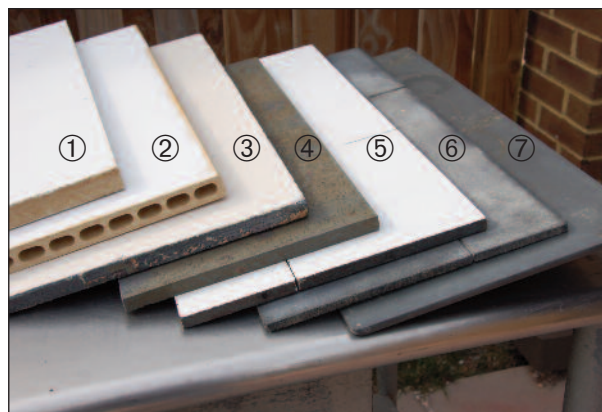

Photo: Bill Schran

Shelf Types:

- ① 1" cordierite
- ② Corelite
- ③ 1970s 3/4" silicon carbide
- ④ 3/4" oxide bonded silicon carbide
- ⑤ 1/2" oxide bonded silicon carbide
- ⑥ 7/16" nitride bonded silicon carbide
- ⑦ 5/16" Advancer® nitride bonded silicon carbide.

Cordierite Shelves

Shelves made of cordierite, a naturally occurring mineral composed primarily of alumina (33% approx.) and silica (60% approx.) with minor amounts of other minerals, have traditionally been used in top loading electric kilns.

The minerals cordierite, mullite and corundum are the primary constituents in the makeup of the shelf. Dry pressing under high pressure usually produces these shelves. They exhibit a low coefficient of expansion and are highly resistant to thermal shock, so they are good choices if rapid heating or cooling is desired.

On the other hand, they are more susceptible to warping at higher temperatures and lack of strength. In industry, cordierite shelves are generally used where the maximum firing temperature is cone 8. Shelves used up to cone 6 should be at least 3/4" thick, and those used to a maximum of cone 10 should be at least 1" thick.

A 1" thick shelf will weigh approximately 21 pounds and cost about \$30. Shelves composed of cordierite generally have a high porosity rate. Porosity of 13% up to more than 20% has been noted. This means if a glaze drip or run occurs, the glaze can more easily penetrate the surface and melt into the shelf. Glaze must be chipped or ground out of the shelf as each subsequent firing will cause the glaze to penetrate further and may compromise the integrity of the shelf.

Kiln wash should be used to protect the surface, using a preferred mix of alumina and kaolin. Cordierite shelves are not recommended for wood or salt firings.



Photo: Bill Schran

Advancer vs cordierite: A demonstration of how the thickness of the shelf affects stacking space. Advancer shelves on the left, 1" cordierite shelves on the right, same length posts in each stack.

High Alumina Shelves

High alumina shelves are generally similar to cordierite shelves but contain a higher percentage of alumina, giving them a higher temperature rating (cone 11) and less susceptibility to warping, though rotating of these shelves is still recommended.

Dry pressing is used to create these shelves. High alumina shelves are denser than cordierite and somewhat more resistant to glaze drips, but they still may have a porosity of up to 20% or higher, making the use of kiln wash necessary.

High alumina shelves are not recommended for wood or salt firings. A 1" high alumina shelf will weigh 22 pounds and cost about \$45.

Corelite Shelves

A recent entry into the list of shelves is the Corelite line produced by Resco Products, Inc. These shelves are extruded with openings through the interior. Resco reports this type of shelf has been used by industrial manufacturers for several years to fire sanitary ware up to cone 9 to save on energy costs. The structural shape of the shelves lightens the weight such that a 12" x 24" x 1" shelf weighs only 12.3 pounds with cost ranging from \$38–\$40.

The shelves are advertised to be light in weight, ground to be very flat, resistant to warping and thermal shock, and less prone to cracking. The shelf composition is a mix of mullite and cordierite, including a high content of alumina (49% approx.) and silica (44% approx.) with about 5% magnesium.

As with the cordierite and high alumina shelves, these shelves are not recommended for wood or salt/soda firings. The porosity is 23% to 28%, so the use of kiln wash is highly recommended.

Though a company representative stated that these shelves can be fired above cone 10, the specification sheet lists the maximum temperature as 2336°F, so long term use at temperatures at and above cone 10 may be an issue. Flipping of these shelves is suggested.

Silicon Carbide or Oxide Bonded Shelves

Silicon carbide kiln shelves have long been the workhorse of the studio potter firing fuel-burning kilns. Also known as oxide bonded shelves, they are composed primarily of silicon carbide and silica. Silicon carbide shelves generally have a much higher maximum temperature rating than cordierite or high alumina shelves.

Dry ram pressing under high pressure is the process used to manufacture most all silicon carbide shelves. Crystolon® brand shelves, manufactured by Saint-Gobain Ceramics, have a composition of 88% silicon carbide, 10% silicon dioxide and .5% iron and other minor materials. These are rated to a maximum firing temperature of 2730°F.

Ashine Industries, Inc. is one manufacturer that produces silicon carbide shelves in China. Their shelves have a composition of 90% silicon carbide, 6 % silicon dioxide, and .5% silica and other minor materials.

These shelves are rated to a maximum temperature of 2370°F. Though these shelves can be fired to higher temperatures and are more resistant to warping, they are more prone to

cracking from thermal shock. To address this issue, some manufacturers, most notably Chinese shelf producers, have begun to introduce expansion slits in the shelves.

Silicon carbide shelves generally have a rather high porosity, between 14% and 18%, so kiln wash is recommended. Oxidation makes silicon carbide shelves more susceptible to warping. When silicon carbide shelves are exposed to oxidation the silicon carbide structure changes and some bond is lost, causing the shelves to weaken somewhat.

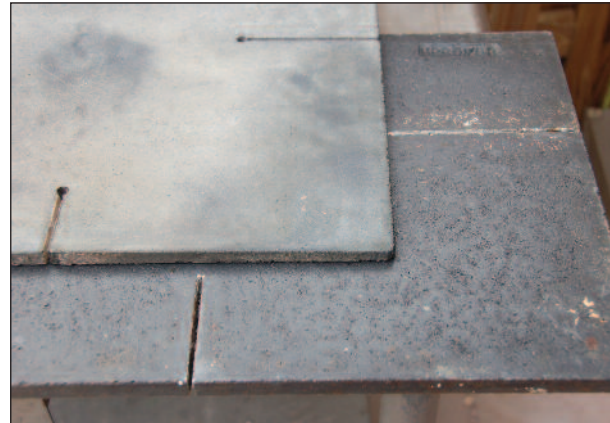

photo: Bill Schran

Nitride and oxide bonded silicon carbide shelves with expansion slits to relieve stress and prevent cracking.

Euclid's sells an oxide bonded silicon carbide shelf made by Jiang Xi Jiujiang Heping Kiln Furniture Co., Ltd. that comes with a wash of 98% alumina and 2% bentonite applied at the factory.

These shelves also come with expansion slits to release thermal stress at high temperatures. A 12" x 24" x ½" shelf weighs 14.7 pounds and a ⅝" shelf weighs 16 pounds. The ½" shelf sold by Euclid's lists for \$60. The Crystolon, 12" x 24" x ⅝", weighs 17 pounds and lists for about \$88 from Smith-Sharpe Fire Brick Supply.

Thickness of the Crystolon shelf is determined by shelf size, as are other shelves, to allow the manufacturer to handle the shelf in its green state prior to firing and to control warpage. A larger shelf requires a greater thickness to control warpage during firing, taking into account load and application.

Due to their resistance to corrosive atmospheres, silicon carbide shelves are recommended for wood-fired and salt/soda kilns. Smith-Sharpe recommends minimum $\frac{3}{4}$ " silicon carbide shelves for wood or soda firing.

Nitride Bonded Silicon Carbide

Nitride bonded silicon carbide shelves provide a very strong shelf that is thinner and weighs less than the oxide bonded silicon carbide. A 12" x 24" x $\frac{3}{8}$ " nitride bonded shelf weighs 11 pounds.

Nitride bonded shelves are dry ram pressed, then fired in a nitrogen atmosphere. This produces a shelf that is 75% silicon carbide, 20% silicon nitride, and 1% silicon dioxide with the remaining materials being less than 1% each.

Ashine Industries is one company that manufactures these shelves in China. The maximum working temperature of these shelves is 2480°F (1360°C). Ashine reports their nitride bonded shelves are fired in a nitrogen atmosphere to 2552° F (1400°C). As of this writing, Ashine supplies these shelves to Euclid's and Larkin Refractory Solutions.

Potters reported that the early versions of these shelves without expansion slits appeared to suffer from thermal cracking more frequently than other shelves. Manufacturers have responded that potters are subjecting these shelves to thermal stress from rapid heating or cooling.

Like some silicon carbide shelves, the nitride-bonded shelves now have expansion cuts to release thermal stress that might otherwise lead to cracking. Whether these cuts provide sufficient relief from thermal stress is still debated in the industry. Some have suggested the inconsistent quality of the materials or inconsistent firings may be a factor with the cracking issue.

Nitride bonded shelves have a porosity of 16%, similar to oxide bonded shelves, so use of kiln wash may be advised.

Advancer Shelves

Advancer® is a patented brand of nitride-bonded silicon carbide shelves manufactured by Saint-Gobain Ceramics. The Advancer product line was originally developed in the late 1980s for the commercial porcelain industry in Europe and soon found its way into the sanitary ware market and other technical applications.

The Advancer shelf is $\frac{5}{16}$ " thick. A 12" x 24" Advancer weighs a bit over 9 pounds, providing for the possibility of faster heating and cooling. Kiln wash is not necessary to protect the surface and glaze accidents can be removed by scraping with a putty knife, and as needed, a light application of an angle grinder fitted with a masonry disk.

The shelf is produced by slip casting using careful quality control of the materials. The shelves are composed of 70% silicon carbide and 30% silicon nitride bond. The maximum firing temperature is 2642°F. The shelves are fired twice, the first time in a nitrogen atmosphere to a top temperature that is proprietary to the company, though it is probably in the 2700°F range. A second firing, oxidizing in air, produces a very tight oxide layer. This process produces a shelf that has a porosity of <1%.

Because of this very low porosity, potters must understand a couple of issues with the Advancer shelf. Because these shelves are so tight, if they get wet it is difficult to remove the moisture by evaporation, and if they are fired prior to removal of all water they may explode.

Saint-Gobain Ceramics published a technical bulletin warning exposure to prolonged moisture penetration, including rain, snow and condensation may result in explosive breakage. These shelves should be stored in a dry enclosed area. The technical bulletin outlines a specific regiment to follow to slowly heat the shelves to safely remove moisture.

Tips for Using Advancer Shelving

Many porcelain clays may be subject to “plucking” when fired on Advancer shelves. Plucking is a situation where the clay partially fuses to the shelf, resulting in areas breaking off the foot or bottom of the pot. This issue can be resolved by either adding a small amount of alumina to cold wax prior to waxing the bottom or sprinkling a small amount of alumina on the kiln shelf.

Advancer shelves are also subject to issues with uneven thermal gradient (the temperature across the shelf) that, if significant enough, may lead to failure. Direct flames on the shelves and crash cooling are instances that may lead to thermal breakage.

Advancer shelves may be used in soda/salt so long as a soda/water solution is not sprayed directly onto the shelves. They may also be used for wood firings, but must not be in the path of direct flames.

For more detailed information about Advancer shelves, readers are directed to articles found on the Smith-Sharpe web site: www.kilnshelf.com.

For a list of all of the individuals and companies that have provided me with valuable information, product samples and full shelves for testing in cone 10 reduction firings, see 21stcenturykilns.com.



This is Nils Lou's small kiln that exploded because of a damp Advancer shelf. A student mistakenly washed an Advancer in water and let it soak to clean it.

Some Personal Observations

I have been involved with firing ceramic ware since 1972. I have fired a variety of brands and sizes of electric kilns. I have also participated in building and firing gas-fired kilns and have fired a variety of commercially manufactured gas fired kilns. There are manufactured gas kilns that are very well engineered and make firing a fairly simple operation.

In addition to my kiln experiences, I have also used a variety of kiln shelves. Back in the 1970s potters were often limited in their shelf options. Usually $\frac{3}{4}$ " silicon carbide shelves were used in fuel-fired kilns and cordierite shelves were the choice for electric kilns.

Potters now have several options, with each type of shelf having advantages and disadvantages.

At the school where I teach I have begun long term testing of most all of the shelves I have written about. We have been using Advancer shelves in our gas-fired kiln for about 2 years. We have never applied kiln wash to them. We have experienced many glaze run issues and have even had a low fire clay pot mistakenly included in a cone 10 firing.

In all instances, most all of the glaze pops off with a putty knife. A quick application of an angle grinder removes any remaining glaze. I have noticed the shelves will pluck pieces of the kiln post that remain attached to the shelf and require the use of the angle grinder. Coating the post ends with alumina may resolve this. I have not observed any warping of the Advancer shelves.



Photo: Bill Schran

Use an angle grinder fitted with a masonry grinding wheel to remove glaze drips.

I also use the Advancer shelves in my electric kiln for firing of crystalline glazes. I use these shelves to remove the variable of kiln furniture retaining heat when I have programmed rapid cooling ramps. I also need to be concerned about glaze accidents that are a more likely occurrence in crystalline firings.

Our old silicon carbide shelves are warped from years of firing and not flipping them. They are very heavy and are held in reserve to finish loading a firing if needed. I will be flipping these shelves to see if they will flatten out over time. Some have small cracks, but have been that way for many years, and the cracks have not enlarged.

The oxide bonded silicon carbide shelf that came from the factory with a coat of kiln wash seems to be holding up well, though after two firings it came out of the kiln with a rather glossy surface on the unwashed areas. Whether this is due to oxidation of the silicon carbide creating a glassy surface is unknown.

We decided not to apply kiln wash to the nitride bonded silicon carbide shelf to test how resistant the shelf might be to glaze accidents. The glaze accidents that have occurred so far came off fairly easily with the angle grinder. Porcelain clays are subject to plucking on these shelves. After three firings I noted a slight warping of the shelf. I will continue to monitor this very carefully.

The shelf manufactured by Resco that has the openings through it seems to be holding up well in the cone 10 firings. I have applied a wash of 50/50 alumina and kaolin. I will continue to fire these shelves without rotating until any deflection is seen. I did notice the shelf color has darkened and the surface seems to be more vitrified. Some glaze drips that have gotten through the layer of kiln wash, into the shelf have required removal with an angle grinder.

This has resulted in small areas of the shelf being ground away. I am pleased to see this product on the market as I think this may be a good, affordable alternative for folks with larger top-loading kilns who need something lighter in weight than the 1" thick solid cordierite shelves.

William "Bill" Schran has been involved in ceramics since 1972. During those 35+ years of working with clay, he has evolved from student to teacher, from beginner to craftsman, but in those years, he has always remained constant as an innovator. For the past decade he has devoted his research to the exploration of cone six crystalline glazes and has written two articles on the subject. Beyond the chemistry of this complex process, he has sought to study the multiple variables that may affect successful results - even the effects of the type of shelves used in the kiln.

*Bill can be found at:
creativecreekartisans.com*

STEP 13

Plan for Firing Safety

Before you fire your kiln, make sure you have taken all necessary safety precautions.

Site Safety Precautions

Prepare for the worst. Make sure you have a sign posted near your kiln that includes gas shutoff instructions, your fire number or address, and the location of the nearest fire hydrant. **If firefighters do come, let them know they cannot spray water on a hot kiln. It will explode.**

Keep your site clean. Clear away all debris and anything you can trip over.

Creative Tips for Site Safety

Let's face it, a kiln site is likely to be attractive to seedy characters like neighborhood teens, fine arts majors, and so on. Beyond fencing, you can try some creative security measures. Mel has empty beehives in his backyard. No one enters the property. Some folks post signs that say "Danger: 25,000 volts." It may not be true, but intruders will not touch a kiln with a sign like that.

Create a Decorative Cement Wall

If you have your kiln in a burnable building, it may be prudent to build a decorative cement wall. There are many forms of thin concrete wall materials that you can stack against a sheet rock wall. Adding a metal/corrugated roofing wall is very nice. The important aspect is to keep the metal from touching the wall. Put in spacers. There are dozens of creative ways to protect burnable walls and ceilings.



photo: Tom Wirt and Betsy Price

This switch on the front of Tom Wirt and Betsy Price's studio controls a solenoid that can completely shut down gas to the kiln.

Personal Safety Gear

You'll want heavy-duty boots and welding or other heat-protected gloves. If you wish to look inside the kiln at maximum heat, you'll need welding goggles to protect your eyes.

Fire Safety Precautions

Most fires start in the roof or other wooden structures near the kiln. During the firing, the structure that covers the kiln must be kept cool (and damp if possible).

Fires around the stack are common. If that stack gets really hot, it can transfer heat to the structure.

Air flow is critical. The more air you can move around a firing kiln the better. Dead air trapping heat is a primary cause of fire. If your kiln is in a building, make sure windows are open, and fans are running. An old box fan on the floor moving air towards the kiln is a good thing. Big attic fans mounted in your studio wall are great for venting a big kiln.

Several potters have been told by firefighters that the ignition temperature of wood that is repeatedly exposed to heat will decrease over time. This means the wood can catch fire at a much lower temperature than before—so an area that you always assumed to be fireproof may no longer be safe.

Keep a fire extinguisher and hose ready, but be aware that this is only to protect structures near your kiln. A simple garden sprayer filled with water, and on the mist setting is wonderful to cool walls or beams in your ceiling during a firing. **But remember: Never spray a hot kiln!**

Beware of Carbon Monoxide

The other major safety hazard is carbon monoxide poisoning. Carbon monoxide must be watched for at all times. The best warning sign for a potter is **headache**. If you have the slightest headache, dizziness, or nausea, check for leaks, gas, or smoke.

Carbon monoxide is invisible and odorless, so careful checking is critical. At various times during the year it is a good practice to use a soap wash to check all gas fittings. Make sure they are tight and safe. Make sure you have adequate air movement in your room.

Never fire a kiln in the room you are working in. Never. You should only enter the kiln room to check it. Do not stay near the kiln for long periods of time. Check the firing, then step away.

Never fall asleep while you are firing. This is a recipe for disaster. And always make sure you have another person around who knows you are firing your kiln. That person must know where the gas valve is for shutting off the kiln.

Create a Firing Checklist

It is important that you create a safety checklist you can follow whenever you fire your kiln. Think of firing your kiln like flying a plane. Check that all systems are in perfect running order before you take off.

Note: We have provided a basic checklist (and more firing safety tips) for you in *Chapter 12: Firing Safety Tips for Gas Kilns*.

3

KILN STORIES: SMALL FLAT-TOPS

About the Kiln Stories

If you want build your own kiln, you can gain a great deal of insight and information from others who have done it themselves. The following stories come from people just like you who took on the challenge of building their own kilns and have had successful results.

There is no “one way” in kiln building. The nature of your environment, whether city, suburban or rural makes a huge difference.

Bill Burgert’s backyard kiln in Denver is a prime example. He was able to squeeze that kiln into a small space and still have neighborhood acceptance. He has a great kiln, firing to cone 6 reduction without smoke or anything that could disturb his neighbors. No one ever knows when he fires. He is invisible. And the kiln looks like a barbeque or food smoker.

He has been prudent and cooperative and he also gives his pots as gifts to neighbors. He’s done it right. As can you. One of the following examples will fit your needs. Look at them all; compare and decide. It can be done.

This first story shows the basics of building a well designed and fully tested kiln that can be placed in a very small space, with very flexible plans that can be adapted for your needs.

Building a Small Flat-Top Kiln by Mel Jacobson and Kurt Wild

Since the plans are flexible, the “Minnesota flat-top” kiln design by Nils Lou can be sized to fit almost any space or studio. We have built them as small as 10 cubic feet and as large as 60 cubic feet with a car system. Keeping in mind that the flue size does not need to change and the burner system is constant regardless of kiln size, you can build a kiln to suit your situation. A kiln of about 25 cubic feet is ideal for a home potter with limited space.

This kiln can be built to use natural or propane gas. A small gas kiln can use a limited amount of fuel and be as safe as electric firing—just a simple shed roof is all that is needed for cover in most situations. I have built several of these kilns in garages. Just keep in mind that a good amount of space—at least two feet on each side—is needed around any fuel kiln.

Since these plans are for the kiln we built for Kurt, we have provided a materials list, and Kurt offers building tips.

We suggest that you obtain a copy of *The Art of Firing* by Nils Lou. This book contains a wealth of photos and instructions for building and firing kilns, especially the Minnesota flat-top. Following the basic ideas of Nils Lou but being a bit creative will allow you to have a kiln that is “the perfect fit.”

The Building Process

The Foundation

The site for building the kiln should be a flat, clear area with a compacted gravel base or a concrete slab. The base for the kiln and stack are constructed using a combination of 8" and 12" concrete block. This kiln has a layer of 8" block positioned so the holes in the block run horizontally to allow air to pass under the kiln. A layer of 12" block with the holes in a vertical position is placed on the smaller block, overlapping the seams. Another layer of 8" block is placed on top of the 12" block in the same pattern as the bottom layer (*see drawing 5 at the end of the story*). Once the concrete block is in place and level, place a layer of expanded metal or cement board on top as the base for the kiln floor.

The Floor

The floor of the kiln and the stack consists of three layers of brick. First, a layer of hard brick; second, a layer of soft brick (K 23); and third, another layer of hard brick. The two layers of hard brick can be laid in the same pattern, but the pattern of the middle layer of

soft brick should be changed so the joints are staggered between layers. You should pay close attention to maintaining a level, flat surface with each layer of brick. This attention to detail will help ease the construction of the rest of the kiln.

The Walls

A note about the bricks: Though the kiln is made mainly of soft brick, you will want to use hard brick around areas that experience wear and tear—the burner ports, the corners of the roof, and the chimney.

The first course of the wall is a soldier course of soft brick. The bricks are placed on edge so the layer is 4½" high. You should start with the back wall (*drawing 6*) to position the flue (4½" x 7") and the burner ports (4½" x 4½").

You will notice that the flue opening is just slightly off-center on the drawing to allow for use of a full brick on one side. This will not affect the kiln's operation. Continue with the soldier course and allow for the door opening. These plans show the door on the front wall of the kiln (*drawing 4*) but in Kurt's kiln the door was placed in the sidewall. Either option will work.

Once the soldier course is completed, continue building the walls. Rows 5 through 16 are laid in alternating courses (*drawings 2 and 3*).

When starting to place the brick for row 5, you may need to adjust the brick on the back wall so that there aren't any joints above the flue or burner port openings.

Tip: *To make the flue and burner ports fit correctly, and to compensate for variation in brick size, some insulation bricks will need to be trimmed to size using a hacksaw or a regular handsaw.*

Be sure to maintain the proper width for the door opening as you build the walls. You also need to build in peepholes for viewing the cone packs and the inside of the kiln during firing.

Peepholes must be planned to be in a safe place, perhaps halfway up the door. Many prefer a peep in the front of the kiln, centered on the wall. A “V” cut in the inner wall brick, with a matching half brick (made a bit loose to be able to be removed) works well. The cone pack is placed on a corresponding shelf for easy viewing. Many potters add 4–5 peepholes in the kiln, and use whatever one is convenient for that firing. Kaowool plugs also work well for peepholes. Some potters just drill a large hole in the kiln body and plug it with Kaowool.

Some people have used a brick built into the wall that projects into the chamber as a shelf for the cone packs. You do not need to do this if you place your cone packs on the shelves with your work.

The Roof

Tip: *Although you can perform most of the construction process as an individual, it is a wise decision to enlist help from others for several of these steps, especially when building the roof.*

Step 1: The roof consists of insulating firebrick stacked on end in multiple rows and clamped together. The corners of the roof are made of hard brick. The first step is to cut out a $\frac{3}{4}$ " plywood deck that is just slightly smaller than the inside dimensions of the kiln chamber. Be sure to include the opening left in the wall for the door. This piece is mounted in the kiln using 2x4 braces placed at a slight diagonal to allow for easy removal when you are finished building the roof. Be sure to use plenty of braces around the perimeter and in the middle of the form.

The top of the plywood should be slightly higher than the kiln walls to allow for the thickness of the ceramic fiber placed on top of the wall as a gasket.

Tip: *Place a chalk line on top of the plywood to mark the center of the kiln from front to back. This line will help keep the roof square while placing the brick on top of the plywood.*

Step 2: When placing the brick in position, dip the top 2/3 of each brick in a very thin slip made up of equal parts fireclay, common sand and water. This slip should be thick enough to lightly cover the brick's surface, not just stain it. Leaving the bottom 1/3 of the brick “clean” will help prevent clay particles from the slip from falling into the kiln during the firing. The clay slip on the top part of the brick will help hold it in position when clamped together in the next step. Set each brick in position with the clean end against the plywood. Work from the centerline out to each edge starting at the front of the kiln.

Butt the bricks as securely as possible; small gaps will disappear when the bricks are clamped together. You do not need to dip the bricks that rest on the wall into the clay slurry. Place the three hard firebricks on each corner as shown in drawing 7.

Step 3: You are now ready to place the corner braces and tie rods in place. Make the four corner braces by welding pieces of 2" x 2" x 1/4" steel angle iron together and drilling holes in the appropriate locations (*inset on drawing 7*). Position the braces, add the tie rods, nuts and washers, and snug them up evenly.

Step 4: Place hard firebrick splits between the brick and the tie rods on each side of the roof (*drawing 7*) before tightening the nuts on the tie rods. This will keep the bricks from bowing out or the tie rods from bowing in during the tightening process.

Step 5: Once you have applied a slight tension to the roof structure, remove the middle inside support. Replace this support with a shorter one and a hydraulic jack. Raise the center of the roof about 3/4" to cause a slight domed effect. Continue tightening the tie rods in an equal manner, working from front to back and side to side in several steps. Use a torque wrench and tighten them to about 40 ft/lbs of torque. The roof is now a slightly domed, solid slab.

Step 6: Once you fire the kiln you will want to re-tighten the nuts to 40 ft/lbs to allow for any stretching of the metal tie rods or shrinking of the brick.

Tip: It is a recommended practice to check the tension of the tie rods every several firings throughout the kiln's life.

Corner Braces

You can now add the bracing for the corners of the kiln structure. This consists of a 2" x 2" x 1/4"-thick angle iron that is approximately 76" in length on each corner joined by tie rod or cable. A unique feature on Kurt's kiln is the use of 1/8" steel cable and eyebolts to join the corners together. The eyebolts are placed in holes drilled through the angle iron. The holes are drilled so that the top holes are 2" above the roof and the bottom holes are 4" below the hard brick floor. One end of the cable is looped through the eyebolt and fastened with a cable clamp. The other end is passed through the opposite eyebolt, pulled tight and fastened with a cable clamp. When all 8 cables are in position, slowly and alternately tighten the nuts on the eyebolts to create an even tension on all the cables.

The Flue Box and Chimney Stack

The flue box is designed to create a double venturi effect on the gases coming from the kiln chamber. This system of restricting, then expanding, then restricting and expanding again is used to create a strong draft of the flue gases and turbulence within the kiln chamber. The flue box should be mortared so that the draft is not undermined by air leaks.

The flue box uses a combination of hard brick laid flat and hard brick soldiered to make the 1" slot for the damper (*see drawing 8*). The damper is made from a 1" thick piece of Kaowool "M" board. The top of the flue box is the second area of restriction before entering

the chimney stack. This opening is the same size as the opening from the back wall of the kiln into the flue box (4½" x 7").

The chimney stack is composed of 10" inside diameter galvanized pipe and Kaowool sleeves approximately 9¾" in diameter. These will slide into the metal pipe providing you with a ceramic fiber chimney. The chimney stack should sit on a piece of the ceramic fiber board or blanket to provide an airtight seal against the brick of the flue box.

The chimney stack on Kurt's kiln is 10 feet high. The height can vary to some degree without affecting the firing of the kiln. If your kiln is going to be located inside, the chimney needs to extend through and beyond the peak of the roof. It will be supported and secured by the roof structure. If the kiln is outside, you will need to support the stack either by having a shed over the kiln or by using a guy wire system to hold the chimney in place.

Burners

The burners for this kiln can either be a high velocity propane or natural gas with forced air. Your burners should have the required safety devices such as a pilot/thermocouple safety shut off system and be installed to meet safety codes in your area. The burners are placed on either side of the chimney with the flame entering the chamber against the inside of the wall. Target bricks set along the flame path can be used to direct the flame where needed. These bricks can be moved around to fine tune the firing of the kiln.

Other Notes

The internal measurements of Kurt's kiln are 31½" wide x 36" deep by 34½" high for a total of 22.6 cubic feet. The actual setting space, using two 12"x 24" shelves side by side set 2" off the floor, is 10.8 cubic feet. Facing into the kiln, the shelves are set so that they are 4" from the left wall and 2½" from the right wall with the flue opening. The shelves are placed so there is a 6" space on both the back and front side of the shelves to act as the flame ways for the burners.

Kurt Wild is the co-developer of the small Minnesota flat-top kiln, along with Mel Jacobson. As a former professor of ceramics at the University of Wisconsin, River Falls, Kurt has been a leader in kiln design and innovative firing techniques.

Kurt Wild can be reached at: kurtwildpottery.com

(Turn page for materials list and kiln plans.)

Materials List for Kurt Wild's Version of the Minnesota Flat-Top Kiln:

51 standard 8" cement blocks
(7½" x 7½" x 15½")

12 12" cement blocks
(7½" x 11½" x 15½")

3 4" cement blocks
(7½" x 3½" x 15½")

Expanded metal or cement board as the first layer over the cement block and before laying the brick. For the kiln proper, 1 48" x 54" piece or 2 24" x 54" pieces are required. The stack base requires 1 18" x 18" piece.

800 K23 insulating firebrick
9" x 4½" x 2½"
(this amount includes about 20 extra bricks to cover breakage and or cutting).

220 hard firebrick (straights)
(9" x 4½" x 2½")

8 #2 split hard firebrick
(9" x 4½" x 2")

2 #1 split hard firebrick
(9" x 4½" x 1½")

2 1¼" split hard firebrick
(9" x 6" x 1¼")

4 thin split hard firebrick
(9" x 4½" x 1")

1 2½" x 4½" x 12" (or 12½")
hard firebrick (for over damper slot)

12" x 24" shelves as desired

Shelf supports as desired

1 piece of Kaowool 48" x 54" or

2 pieces 24" x 54"

(optional/desirable added
insulation over top of kiln)

"M" board for damper and base of metal
stack sleeve

10 12" Kaowool sleeves
(8½" ID x 12" length x 9½" OD
to line galvanized metal stack

2 5' sections of heavy galvanized pipe for stack (to be lined with the Kaowool sleeves). Using standard 2' lengths of galvanized pipe is not recommended, as the Kaowool sleeves do not readily slide down the pipe. Any heating and sheet metal shop can fabricate 5' lengths. Be sure to provide the shop with a Kaowool liner to ensure a decent fit.

1 72" piece of 2" x 2" x ¼" angle iron
for fabrication of the 4 roof corner braces.

½" cold rolled rod
to connect the roof corner braces:

4 52" pieces for the sides

4 45" pieces
for the front and back (each rod must be
threaded 3" on each end).

16 ½" nuts and 16 ½" washers.

4 Corner, upright angle iron braces
(2" x 2" x ¼") 76" in length.

⅛" steel cable to fasten upright braces (You
may want to have the cable cut to size at
the hardware store as it is difficult to cut
without proper tools.)

This kiln required 4 56" pieces,
and 4 48" pieces,

16 ⅝" x 4" eye bolts

16 ⅝" nuts

16 ⅝" washers

16 cable clamps

Kurt Wild's Flat-Top

A One-Person Kiln

The reason we feature this set of plans is simple. One person can construct the kiln in a day. It is of course advisable to take longer, and have a helper or two. The only welding that is essential are the corner brackets. Any welding shop can assemble them in a short time, at little cost. The rest of the kiln can be assembled using aircraft cable and or bolts and brackets. Several potters I know have used rivets.

The plans are flexible. Just keep the flue size the same and adapt these plans to fit your space.

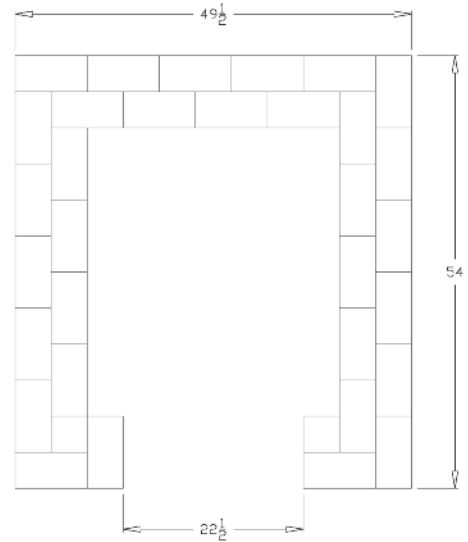

Drawing 2 ROWS 8,9,10,12,14, & 16

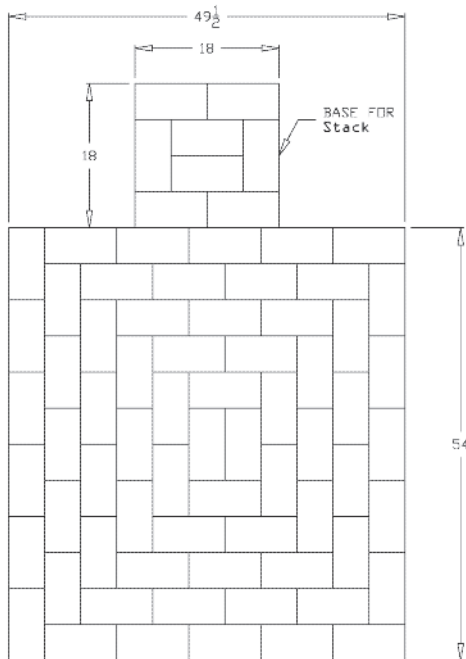

Drawing 1 FLOOR

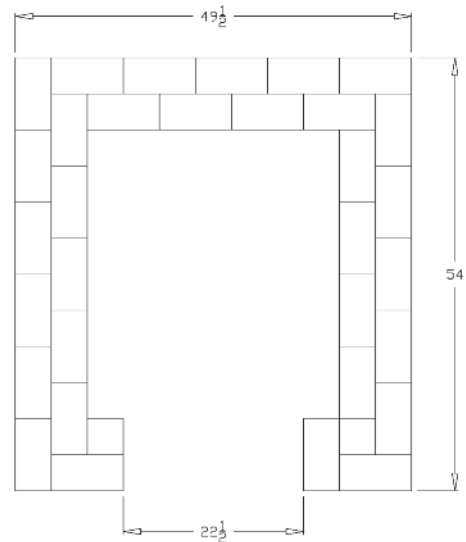

Drawing 3 ROWS 5,7,9,11,13, & 15

illustrations: Mark Elias

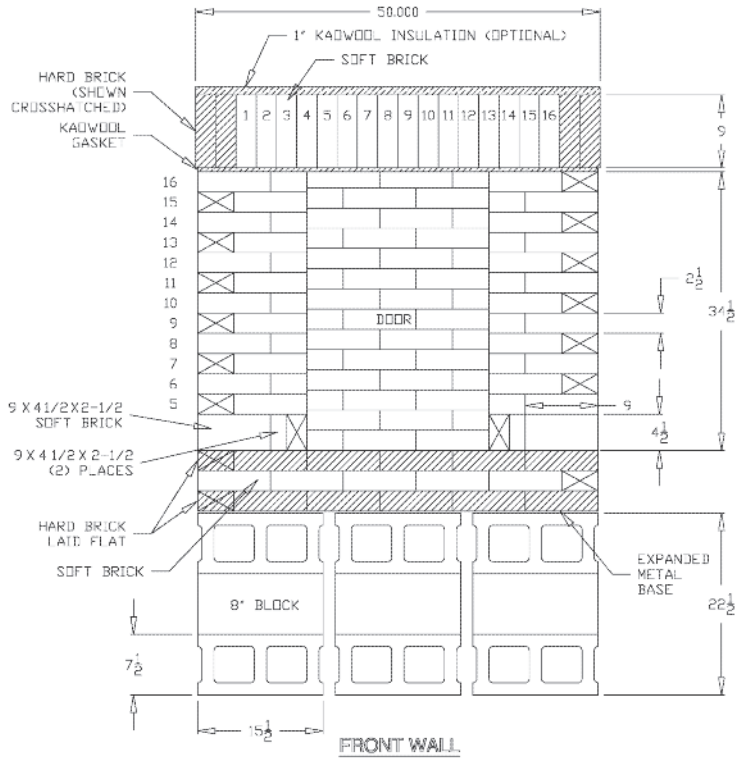

Drawing 4

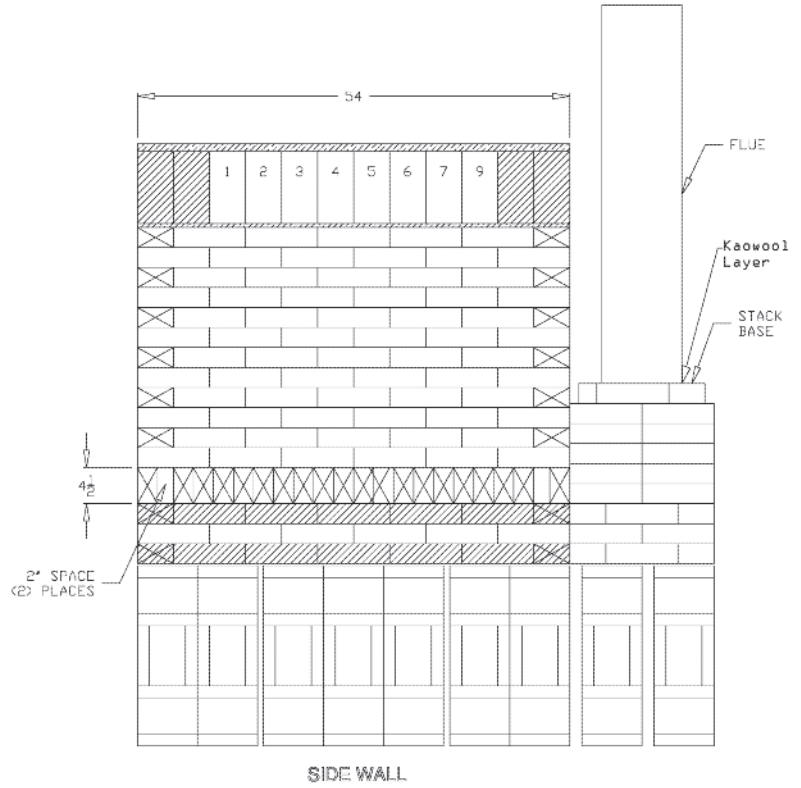

Drawing 5

illustrations: Mark Elias

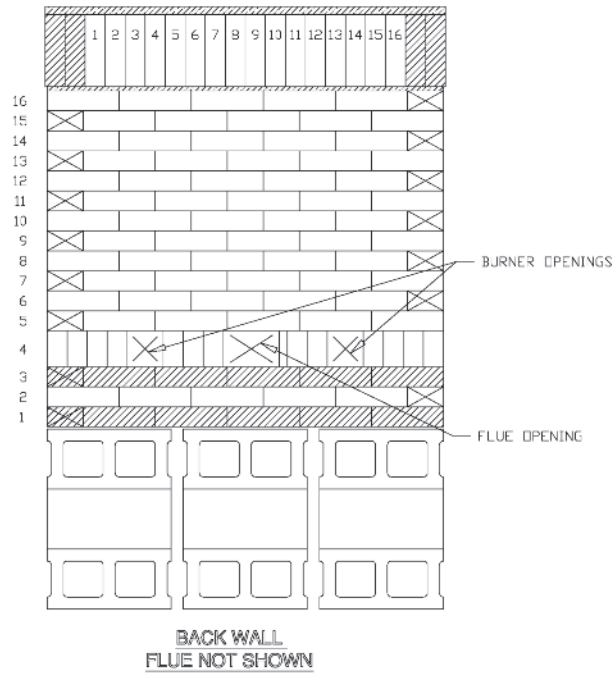

Drawing 6

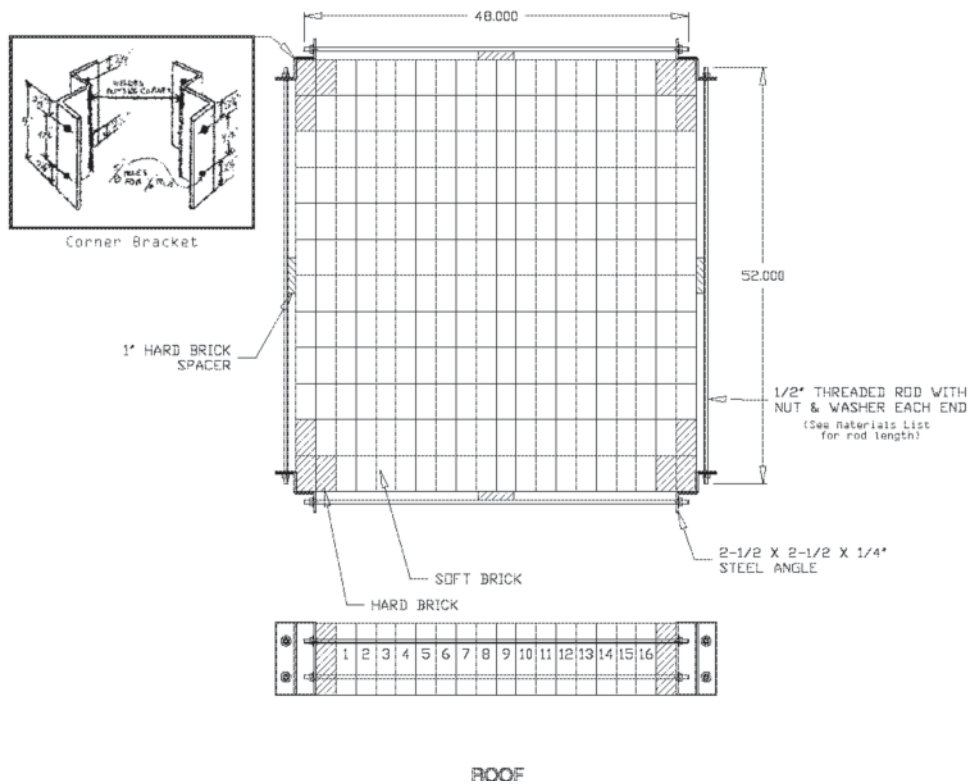

Drawing 7

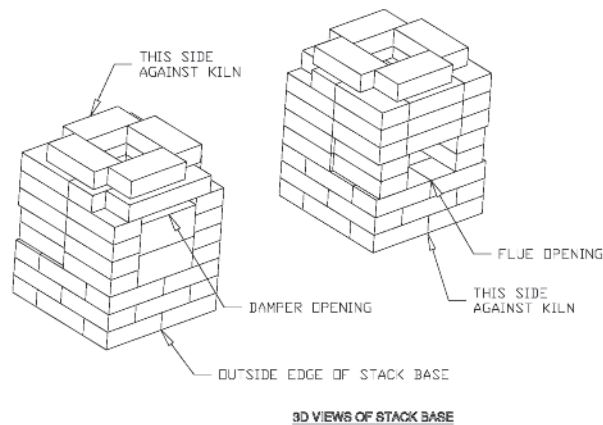

Drawing 8

Illustration: Mark Elias

Hand Stacking the Door

There are a number of options when stacking the door of a flat-top kiln. In most cases, making an interlocking system is the best. This kiln is designed with a 22½" door. That's an opening of two and a half bricks. By alternating a half brick from left to right the stack will rise without gaps. (Some folks just turn that third brick perpendicular to create a half brick, rather than cut it.)

If you are a larger person, it may be prudent to make a three brick opening. That will allow you just a bit more room.

The bricks will rise to the top of the opening in order. It is wise to leave a small gap at the top of the door stack. The final bricks can be shaved to make the top of the stack. Many potters will push in a gasket of kaowool/ceramic fiber to fill the final gap.

If you pull the last row of bricks out at least one inch, they will be easy to remove when the kiln is cool.

Note: If the door stack is at all loose, it may be prudent to run a soldier course now and then, meaning a row of perpendicular bricks five wide.

Mark or number your door bricks so you can stack them in the same order each time. Some potters place their bricks on a wooden rack when they unstack the door after firing. This keeps the bricks in order and ready to go for the next firing.

Use new brick that are clean and flat. This will allow the door to be installed over and over in the same configuration. Making sure the base of the door is clean, very flat and without gaps will help the door go in perfectly each time.

My Flat-Top Kiln **by Bob Anderson**

I believe it was about the mid '80s when I helped build my first kiln, at the middle/high school where I taught art for 34 years. It was a catenary arch, downdraft, about 16 cubic feet. Since then I've helped build two flat-tops. I laid out the plans for an indoor kiln room and built another flat-top at my hometown's new middle school two years before I retired from teaching. At that time, I had no need for my own studio and kiln because everything I needed was right there at the school, and the administration had no problem with my personal use of those facilities. However, in anticipation of my retirement, I realized I would have to build my own shop and kiln.

The scariest part is the kiln roof. A piece of plywood is cut to mirror the inside of the kiln including the door opening. The plywood must be flush with the top the kiln and supported by four 2x4s. Place a thin layer of Kaowool on top of the sidewalls, and begin laying brick on edge for the roof. Keep in mind you need three hard bricks for each corner. Threaded rod and angle iron will be needed to secure the roof. Before tightening, use a small jack to raise the center of the roof slightly. This will cause the roof to bow up one inch and spread the bricks on top of the roof. This space will be filled with clay slurry. When dry, each brick will act as a keystone. Tighten brackets to about 60 lbs. Remove the plywood and stick supports. The roof will not fall. Additionally, welding angle iron to all corners will keep the kiln stable.

Firing

I use two Johnson burners and natural gas in my downdraft kiln. The kiln taps into the shop meter, which is separate from the house. This allows me to get an idea of the cost of each firing, which I've found to run approximately \$10–\$15.

From the meter I've run 12' of 1-inch black pipe underground to within 4 feet of the kiln, at which point the pipe exits straight up 2 feet. A "T" is attached and two ¾" radiator hoses, each 10' long, are connected to the T. Burners are connected to the end of each hose. The flex hose allows me to remove them and hang them from the shed rafters. This kiln fires to a good cone 11 in approximately 7½ to 8½ hours, and takes a day and a half to cool.

And it's all mine!

Bob Anderson can be reached at: sunflowerpottery.com



Bob Anderson's kiln

photo: Bob Anderson

A Backyard Kiln by Fred Paget

When I retired from an engineering career I got back into ceramics. After several years of using the local high school's gas kiln, I decided I had to have one of my own so I would be in control of my firing.

I took a workshop where Nils Lou built one of his Minnesota flat-top kilns in three days with the help of the potters who came. I took pictures of every step along the way.

As there would be a lot of welding involved, I decided to take a 3-month welding course at our community college. We were taught arc and gas welding as well as safety.

I live in a built-up area in a small town where the lots are 50 feet wide. There was not a lot of space on my property where I could put a kiln. I had thought about buying a manufactured kiln like a Geil or Bailey but there was no way I could get it into my backyard without the use of a big crane or helicopter. Finally, I decided to make a small 12-cubic-foot version of the flat-top and put it in my patio area between my workshop and the greenhouse. The space is only 10 feet wide and there is a second unit on my neighbor's property only 15 feet from the rear of the kiln.

I laid a concrete slab on top of the old planter bed and built the kiln on that.

It started with a metal stand made of heavy angle iron which supports the floor of the kiln a foot off the slab. The first course under the floor is low-duty firebrick that is available at our local material yard and that cost only 80 cents each (10 years ago). This is commonly



photo: Fred Paget

Fred Paget's Kiln

used to line the brick fireplaces in houses. The next course is AP Green 2400°F insulating fire brick and the kiln floor on top of that is 3000°F hard brick. Then the rest of the kiln is the 2400°F insulating brick in standard Lou style.

I made the corner ironwork in front extra heavy to support a hinged door. Basically this kiln is a fancy version of what is now being called the Oregon flat-top and is almost the same as the kiln for which Mel and Kurt Wild have published plans.

All the frame is made in pieces that bolt together in sections so that when the kiln is ultimately taken down it can be disassembled and carried out in pieces.

The kiln is covered on the outside with stainless steel sheets. I got the sheets as damaged goods at a junkyard at a good price. They keep the rain off the sides of the kiln. There is a small roof above the kiln made of corrugated iron roofing.

I made my own power burner out of 2" EMT conduit using torch welding. The burner has larger than normal Ransome pilot burners that are used to candle the kiln up to 600°F.



photo: Fred Paget

Fred Paget's burners and stack.

All the usual safety devices are included: BASO valves, power loss shutoff and gas shutoff valves. A permanent sign is posted near the kiln with emergency shutdown procedures in case untrained persons have to shut down the kiln in my absence.

I tapped into the 3/4" natural gas line that runs back to my greenhouse heater. Firing the kiln proved that the gas line was too long and too small to get enough gas to run the kiln. After considering the alternatives, I got the gas

company to raise the gas pressure to one pound per square inch from the previous 1/4-pound pressure. This cost me, but digging up that older line and putting in a big pipe was not an attractive project. This method worked fine.

For instrumentation I have an industrial Yokogawa pyrometer with type R platinum thermocouple, an Oxyprobe, and an old model industrial circular chart recorder. I do, of course, use cones, but if you watch the time temperature curve on the recorder you can usually tell what cone is melting by watching the rate of rise and the temperature and matching it to the Orton charts. These instruments allow an inexperienced person like me to see instantly the effect of any small adjustment of firing conditions and to take immediate corrective action. Using these instruments on my first firing of the kiln, I got a good firing of Tom Coleman copper red glazes.

If you watch your reduction on the Oxyprobe, you can run the kiln in reduction with no smoke to bother the neighbors. They don't even know I am firing.

There is a tall tree's bare trunk only a few feet from the steel pipe chimney of the kiln. I had to fit the tree with a sheet metal heat shield to keep the radiated heat from killing it. On the side of the kiln near my studio wall I mounted the door of an old refrigerator to protect the wooden wall. The door's handle is handy to grab when going up the steps to the back of the kiln area. The kiln space is raised 13" higher than the patio floor so there is a two-step stair at the side. On the other side the wall is cement.

Fred Paget's Mini Test Kiln

My second kiln is a sort of mini test kiln—gas fired. I made it out of surplus bricks and metal from the big kiln project. It is only about 1½ cubic foot inside.

It is a flat-top with a roof made of insulating bricks held together with stainless steel rods in bored holes inside the bricks. The chimney is an iron pipe with a Lou venturi box for the damper in back under the chimney. The damper is a piece of sheet metal that I have had for ages. It is an alloy used in making jet turbine engines called Hastalloy and shrugs off cone 10 with ease. The kiln is covered with stainless steel sheet metal leftovers. I put a layer of 1"-thick ceramic fiber board under the outer stainless steel skin since the kiln was built with only one brick thick walls.

The first burner setup was a quad forced air burner; four small tube burners using ¾ - diameter tips firing up through the floor on four corners. It would go to cone 10 with no trouble, however when I wanted to fire to much lower cones for experiments in Moorish Luster glazing it was uncontrollable, so I junked it out and bought a small venturi burner. It is installed firing up through one hole in the middle of the floor. A shelf on short posts acts as a bag wall. I did interesting reduction firings at cone 020 using fatwood sticks and histamine fire starter tablets (a safe substitute for naphthalene moth balls).

I am thinking of doing some experiments with soda firing and will probably use the little kiln. I ought to get a dozen or so firings before the bricks go bad and then I will possibly rebuild it

again. It is small enough that I could line the rebuilt kiln with kiln shelves to resist soda. Just an idea.



photo: Fred Paget

Fred Paget's Mini Test Kiln



photo: Fred Paget

Fred Paget's Test Kiln Burners

An Innovative Roof Idea

Bill Merrill has come up with an ingenious idea for a flat-top kiln roof. He drills a hole in each brick and threads them onto $\frac{3}{8}$ " thick rods. Each row of bricks has a piece of angle iron on top of it for additional stability, and every 3rd to 5th brick is tied to the angle iron with mechanics wire. The wire fits perfectly into a V-shaped groove that you cut into those bricks. Follow Bill's simple instructions below to make your own suspended flat-top roof.

Construction Process of the Suspended Flat-Top by Bill Merrill

The first thing to consider is the size of your kiln. Take your firebrick and lay out the perimeter of your kiln design. Lay in your kiln shelves and place a row of brick to represent the kiln walls. If the design is what you want,

the size of the rows of brick can be determined.

My stoneware kiln is 8 brick wide, or 72 inches. The kiln is 6 brick deep, or 54 inches. The interior space is 36 inches deep and 54 wide. The kiln height from burner port floor to roof is 70 inches. The floor is raised to make a flue channel. The height from the top of the flue channel to the roof is 65 inches. The flue opening is 8" wide and 5" tall. This is large enough and the kiln damper still must be used during firing to create back pressure for reduction.

The angle iron for a kiln roof this size doesn't have to be larger than 2" x 2" x $\frac{3}{16}$ ". Since the kiln is 72" wide you would use angle iron that is 72" long. Since my kiln measures 54" deep I have used 12 rows of brick to construct the roof.

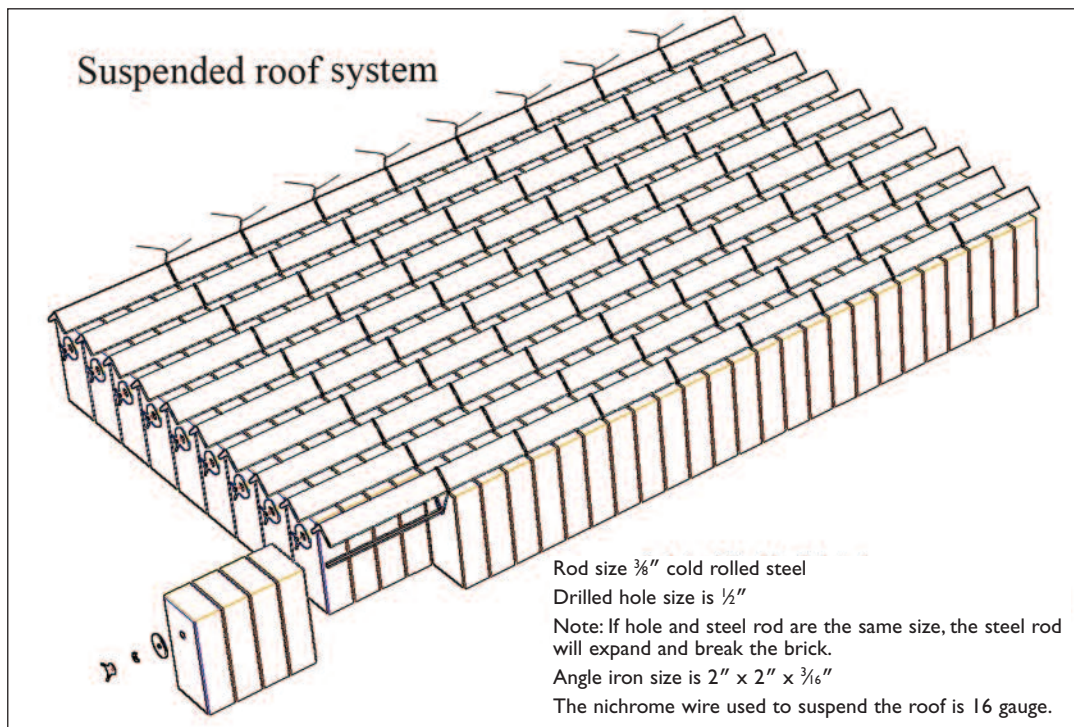

The $\frac{3}{8}$ " rod was made 4" longer than the total width of the bricks required to span the roof (76 inches).

Now that the kiln width is decided, the building of the roof rows begins. The next step is to drill holes in **all** the insulating firebrick that are to be used in the roof.



Construct a wooden template and clamp it to your drill press.

A simple way to ensure all the bricks are drilled exactly in the same spot is to construct a simple wooden template that holds the brick, and clamp it to a drill press.

Measure the center of the hole to be drilled $2\frac{1}{2}$ " down and $2\frac{1}{4}$ " in. Use a masonry bit to drill the hole. The hole is $\frac{1}{8}$ " larger than the cold rolled $\frac{3}{8}$ " steel rod used to hold the row together; this allows the brick to be perfectly aligned when putting the rows of brick together.



Make sure you use a masonry bit to drill the holes.

Note: The next step applies only to those bricks that will be tied with wire: every 3rd–5th brick.

Make a wooden template so you can mark a guideline for the channel. The channel is where the #16-gauge nichrome wire is placed to make the brick rows stronger and stiffer. The widest part of the triangle is as wide as the angle iron used on the roof.



The widest part of the triangle is as wide as the angle iron used on the roof.

Using a straight edge and $\frac{3}{16}$ " drill bit, carve a channel from the drilled hole, following your drawn line. Make the groove deep enough to allow for the nichrome wire to lay.

Lay out your row of brick. Your groove brick may be placed every 3–5 brick apart. Start with a wire in the center of the row and work towards the ends.

Every other row should have a brick cut in half lengthwise with one half of the brick used on each end of the row. The alternate rows use only full brick.

Insert the $\frac{3}{8}$ " threaded rod (use coarse #16 threads) through the bricks after you have placed the groove bricks in place.

Make the nichrome wire pieces 12" long. (The wire needs to be long enough to go above the angle iron and be twist tied.)

Place the wire under the rod and let it travel through the groove. Compress the rows together with the nichrome wire extended under the rod, up through the groove.

Tighten the rows after the wire has been put in place. The angle iron is laid on top of the row and the wire is twisted by hand about two revolutions, enough to allow the wire to start to be pulled tight.

Use a pair of vise grips to pull the wire tighter. Lift the row off the ground slightly and twist the wire slightly tighter. Make sure you don't twist the wire too many revolutions or the wire can break, as it is fairly brittle. The wing nuts can be tightened with your pliers. Use 2" fender washers with a $\frac{1}{2}$ " center hole and a compression washer to help hold the brick.



photo: Bill Merrill

Carve a channel for the nichrome wire.



photo: Bill Merrill

Place each groove brick 3–5 bricks apart.



photo: Bill Merrill

In order to offset the bricks from row to row, place a half brick (cut lengthwise) at the start and finish of every other row.

After the rows are constructed, place them together on the floor.

Before you install the brick rows on top of your kiln, lay a thin $\frac{1}{8}$ " layer of fiberfax on the top of the kiln walls. This will seal the roof and walls and cushion the brick resting on the walls.

Start from the front of the kiln; if the brick are not quite perfectly straight, loosen the wing nuts slightly and tap the brick into place. Then put on the second row. Complete the same step on each row as you go, and there will be a perfect alignment of each row of bricks from front to back. To keep each row together, use mechanics wire to tighten the first row to the second, etc. I have also used a large wood clamp to hold all the rows together.

Now that you have the roof completed, the last thing to do is cut strips of fiber fax and put

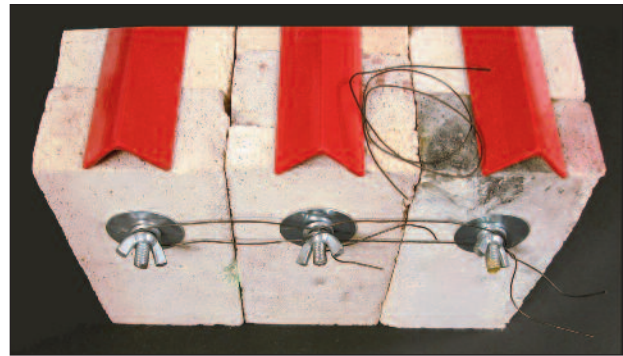

photos: Bill Merrill

Once the rows are assembled on top of your kiln, wire them to each other.

them between the angle iron rows of brick. While not necessary, it would make the kiln even tighter.

My kiln can take five days to cool. If you have things planned out with your firing schedules and let the kiln cool at its own rate, the kiln will last longer and the majority of the glazes will be richer in color.

4 KILN STORIES: ARCH-TOPS

De-Mystifying the Arch

A step-by-step guide for building a perfect arch.

by Donovan Palmquist

I remember the frustration of building my first arch over 30 years ago. I had never built an arch, yet it seemed very simple. I got out the AP Green handbook, plugged in all the numbers and made a form based on the calculations. I made a compass for drawing the radius of the arc down to 64ths of an inch, and drew out the arc and span. It had a nice rise and looked as if it would work well. I constructed the arch form, built the skewers out of standard side skew brick and set the form in place. All I had to do now was put in the arch brick. Piece of cake—or so I thought.

The brick did not fit. I had the right number of brick, the right kind, a perfect arch form and nice skewers, and then discovered that not all brick are the same. The brick were less than $\frac{1}{16}$ " short in the arch dimension. Over the 21-brick span, the slightly narrower brick came up over one inch short. My precision arch form was junk. Back to the drawing board.

At that point I realized the real purpose of arch calculation tables is to estimate how many bricks go into an arch of a given thickness and span. Although there is an industry standard, the dimensions of a #1 arch from company A are often not even close to the dimensions of a #1 arch from company B. The difference between $\pm \frac{1}{16}$ " to a brick creates a whole new problem to deal with; it's up to the mason or builder to figure out how to fit the over- or under-sized brick.

One way to solve this problem is to cast a key, which works well for catenary arch kilns where fitting a key with conventional brick can often be very difficult. This will also work on a sprung arch if you have no alternative.

But the method we now use exclusively is to lay out the arch with the actual brick, giving the precise arc they form. It will be close to the book calculations but does not rely on perfectly-cut brick.

STEP**1****Prior to ordering brick, determine the span and brick requirements of the arch.**

First, we should define the difference between “arch” and “wedge” brick. Arch bricks are used to create an arch that is 4½” in thickness. The taper is along the shorter length. Wedge bricks are used to build an arch that is 9” in thickness. For salt/soda kilns, a hard-brick liner made of 4½” arch bricks, with a middle layer of ceramic fiber and soft-brick backup row is recommended. For reduction kilns, 9” insulation brick wedges work well.

To get a rough idea of the number of bricks for the particular span and rise, use the AP Green arch tables (available on our website: kilnbuilders.com). Start by determining the span of the arch (the kiln’s interior width). Using the span measurement, refer to the arch tables for brick quantities, wedge shapes (#1, #1x, #2, etc.), and brick combinations to find the rise that works best for the span and available brick. Try to use only one or two kinds of wedges. Two inches of rise per foot of span is recommended. This will also give you an estimate for the number of brick needed to complete the arch. Be sure to order a few spare bricks. In the following photos, we are building a soda kiln arch using hard brick liner with insulation-brick backup.

TOOLS

- Heavy flat cardboard with straight edges, larger than the interior width of the kiln
- Tape measure and pencil
- Large adjustable framing square
- Level with straightedge
- Jigsaw
- 14” diamond wet saw
- Utility knife
- ½” plywood for arch form ends
- 2x4s
- ¼” plywood for arch form “skin”
- Chalk line marker
- Drill
- 3” sheetrock screws
- 1½” sheetrock screws
- Shims
- Small C-clamps
- Mallet
- Sanding block
- Car or bottle jack

STEP 2 Create a template for the arch form.

Mark the span on the straight edge of a piece of heavy, flat cardboard. Add 9" on each end to represent the side walls, where the skewback bricks will sit. (The total length of a 45" span will be 63".) Find the center of span and draw a line perpendicular (90 degrees) to the baseline. This needs to be VERY accurate. You will use this to measure and make adjustments to the rise. Estimate an approximate rise, as listed in the arch tables. Mark the rise on the centerline. Now span, rise and walls are represented on the cardboard.

Start laying out the arch by placing the edge of an arch brick along the centerline (*Figure 1*). Fill in the arch from that point in both directions with the proposed brick pattern until you reach the edge or a point slightly beyond the edge of the span. If you are too far off by starting with the brick against the centerline, set up the arch with one brick centered on the key, giving an odd number of brick in the arch. One of these options will work.

Once you have fit the bricks to the span, trace the inside edge of the brick on the cardboard. Using the adjustable framing square to ensure that both left and right brick skew angles match, completes the arch template (*Figure 2*).



Figure 1.



Figure 2.

STEP 3 Determine skew angle and cut skews.

Leave the arch brick laid out on the cardboard. Determine the skew angle using a large adjustable framing square. The arch should be laid out square to the span's line. Adjust the framing square to measure the angle of the skew on the edge of the cardboard (*Figure 3*).



photo: Colleen Reilly

Figure 3.

If needed, adjust the arch slightly to make the skew angle exactly the same on both sides. Once this measurement is determined, carefully tighten your framing square, as it will become the guide on the saw.

The span of an arch can be +/- 1/2" to the actual span of the kiln and still fit nicely (after the arch form is set in place, you'll be able to raise or lower it to make an exact fit).

The skews will be cut from 2 1/2" or 3" straight brick.

Using the framing square as the guide on the saw, flip the framing square so the opposite edge becomes the cutting guide. Create a stop guide for the brick by clamping a small piece of wood to the top of the framing square. Clamp the guide edge of the framing square flush to the bed of the wet saw (*Figure 4*).



photo: Colleen Reilly

Figure 4.

Set the brick in the guide, making sure the longest length of the brick stays at 9" (cutting slightly up the short side of the brick is okay). Cut one brick, then check to make sure the guide is set up properly. Cut-offs from each brick will be used to complete the skew. Stack the cut skewbacks on edge at the top of your kiln walls, forming the row lock course.

STEP 4 **Build the arch form.**

The arch form consists of three main parts: end forms, 2x4 ribs and top “skin.”

To make the end forms, cut the cardboard template with a utility knife. Measure up $3\frac{1}{2}$ ” from the bottom edge of the plywood to accommodate the width of a 2x4. Position the template on the plywood at the $3\frac{1}{2}$ ” measurement (*Figure 5*).

Trace the template outline on the plywood, making sure it’s lined up square to the span. Mark a side line $\frac{1}{2}$ ” in from each end (for a 45” span, the form width will be 44”). This ensures the arch form will fit inside the kiln. Cut the plywood end form with a jigsaw. Repeat for the second end form.

To make the 2x4 ribs for the arch form, measure the interior depth of the kiln. Subtract the thickness of the form ends, and an additional $\frac{1}{2}$ ” to ensure a flush fit (if the interior depth is 45” minus $\frac{3}{4}$ ” thickness for each form and $\frac{1}{2}$ ” to ensure fit, the length of the 2x4s will be 43”). A total of 7–9 ribs works well for a 45–54” arch. Mark the end forms with even spaces between the sides and center. Screw the ends together with 3” sheetrock screws. To keep it from twisting, start with the center 2x4, then screw in the ends. Keeping the form on a flat surface will also help prevent twisting.

To attach the $\frac{1}{4}$ ” plywood skin, measure the depth of the arch form, with the grain going front to back (the plywood will bend more naturally into the arch this way). Cut the plywood to this depth. Measure the length of the arc using a string or flexible tape measure,

and cut the plywood to this dimension. You may need to add an additional section of plywood to complete the arc. Start attaching the plywood to the form squarely using $1\frac{5}{8}$ ” sheetrock screws, starting on one skew side and stretching it over the center to the other skew (*Figure 6*). Snap chalk lines to mark the ribs and attach securely to the remaining 2x4s.



Figure 5.



Figure 6.

photo: Colleen Reilly

photo: Colleen Reilly

STEP 5 Set skew bricks. Make sure the side walls are level and parallel to each other. Set skew bricks in place, making sure the steel supports for the skews are in place. Check that skews are parallel and level from side to side and front to back (*Figure 7*).



photo: Colleen Reilly

Figure 7.

STEP 6 Set arch form into place. To make supports for the form, measure the distance from the floor of the kiln to the top of the wall (not including the skew), and subtract 4" to accommodate the arch form and extra shim space. Cut 4 legs out of 2x4s. Position the 4 legs in the corners and set the arch in place. Make sure the form is level from side to side and front to back, using shims if necessary.

STEP 7 Set arch bricks. Lay out a sample front row of bricks on the arch to check the fit (*Figure 8*).



photo: Colleen Reilly

Figure 8.

If the space in the key is too large, lower the arch; if it is too small, raise the arch to make a snug (not tight) fit. Repeat the sample row in the back. Remove the sample bricks and begin laying out a bonded (interlocked) arch. Start in the back, using alternating half and whole bricks. Fill in the remaining rows with whole bricks until you reach the front row (*Figure 9*).



photo: Colleen Reilly

Figure 9.

The front row will also use alternating half and whole bricks. Measure and cut the half bricks to fit flush with the front of the kiln (*Figure 10*).



photo: Colleen Reilly

Figure 10.

Double-check the fit and carefully remove the arch form. A jack works well for lifting the form just enough to remove the shims. Inspect the position of the brick against the skew to make sure they are even from front to back. Tighten loose brick by gluing with bonding mortar or the fireclay/sand mixture. If you are using 9" wedge brick, you are finished. If a

second row is needed, set the small skew back bricks, and add insulation brick, following the curve of the arch for the best fit (*Figure 11*). Cut key bricks to fit the arc.



photo: Colleen Reilly

Figure 11.

Donovan Palmquist and Colleen Riley are potters in Farmington, Minnesota. Donovan is also owner of Master Kiln Builders.

Master Kiln Builders can be reached at: kilnbuilders.com

An Urban Gas Kiln by Kerry Brooks

Yes, it can happen. It's not easy and it's not cheap but it can be done. If the urban gas kiln is a choice you're considering, there are just a few things to keep in mind. I will give you the story of my experience to help guide you, but each city has different fire codes and residential zoning laws, so make sure you check with your local authorities before committing any of your hard-earned cash to the project. As for me, I'm glad I persisted in finding a way to have my kiln in the city, close at hand. The money, time, and stress I've saved by not having to travel to fire my kiln has been a gift indeed.

Space is Money

Space is the first consideration and space is money in any city. Using the smallest space you can manage will save you money. My space is currently outside, off an alley connected to my studio building. I've also had kilns in industrial areas in Minneapolis, and in those cases it's useful to have a single story structure so the stack doesn't have to be too huge.

A concrete floor is also helpful but not necessary. Wood floors work fine, but the issue is usually weight not heat. I've had a family of chipmunks living under my kiln year-round and the heat doesn't seem to be too much for them. I've also noticed that paper trash doesn't burn under the kiln, so with the proper insulation underneath your kiln and a good kiln design, you don't need to worry about the floor. But kilns are heavy, so make sure whatever structure you're using is strong enough for the weight.

Another consideration when deciding on a space is that you need to be able to sleep at night not



Photo: Kerry Brooks

Kerry Brooks' urban gas kiln

worrying about how close your kiln is to the wall next door. In Minneapolis, the fire code requires the kiln be three feet from a combustible structure, so I trust the fire department to know what they're doing, and that has been enough to give me peace of mind. The definition of "combustible" is important and is probably different from what you may think—which leads us to considering the materials you'll want to use.

Non-Combustible Materials Can Save Space

Even though they cost more at the outset, non-combustible materials can save you a lot of space (i.e., money!) in the long run. Even wood can be considered fire safe if it's treated or painted with fire-proof paint or sealant. There are different grades, and your fire inspector will appreciate you using the highest (yes, most expensive) grade. But if you do the math,

paying a few dollars more up front can be a big savings if you weigh it against the rent you'll pay each month for a bigger space. Having a metal structure is even better. I also have chosen to place a layer of Kaowool over the arch of my kiln just to cover any cracks that may develop unnoticed during a firing. I check for such new leaks regularly and take the time to place a layer of Kaowool over the seam between the car door and the kiln body each time I fire. I have to replace the Kaowool every 50 firings or so, but I suppose that's where my peace of mind limit is found. I also use a zero-tolerance thimble around the stack where it goes through the roof. You can have the kiln at 2400°F and put your hand on this thing. If installed properly, even the oldest, driest wood structure is not going to catch on fire. Of course, the use of insulated soft brick also makes your kiln cooler to the touch (not to mention easier on your back during the building process).

Use a Safe Burner System

Minneapolis requires a triple-safety burner system, and that cost some money but has gone a long way toward letting me sleep. There are pilots connected to a thermocouple and BASO switch system. If the thermocouple cools off, either because the pilot has blown out or for some other reason, the BASO valves turn the burners off. There's also a minimum and maximum pyrometer setting needed for the digital pyrometer system whereby the entire things shuts off if either the minimum or maximum is exceeded. The third safety system is an automatic air intake system linked electronically to the burners. If it isn't open, the kiln won't fire (only needed for indoor kilns, of course).

The gas company for your city can also be important. You can call them and check how much pressure they provide to the building. You'll need to make sure your meter allows what you need to get through to your kiln. In the case of my current kiln, changing from a residential to a commercial meter sped my firing up a great deal and cut my firing costs by more than half.

Talk to the Neighbors

Then there's the human element. Make sure to talk to your neighbors, explain the process to them, and even engage them in the building of the kiln and first firing, if need be. Natural gas kilns can smell bad at different times of the firing and the blower system for the burners can be loud. You're better off being upfront and erring in the direction of full disclosure. Showing them the safety equipment is useful, and helping them understand how it all works is time and effort well spent.

Educate the Fire Inspector

And let's not forget the fire inspector him/herself. Don't assume your inspector knows anything about kilns. In fact, you should probably assume the opposite. Again, a little education can go a long way—not only assuring the inspector of the safety of the kiln but also assuring him about your knowledge of the process. Having any documentation (specs, wiring instructions, etc.) from the manufacturers of the burner/blower/pyrometer systems can be helpful. It certainly can't hurt. In my case, when I built my first kiln in Minneapolis (I'm currently on my third), the fire inspector didn't really know what to expect when he came to look at our kiln. In addition, he was completely

flummoxed when he walked into our space and found two women (!) waiting to meet him. He actually said, “Hmm, girls.” My studio-mate and I just laughed and went on with the inspection. It went fine and we were firing within a week.

So pad your bank account a little, take a few deep breaths, and go for it. I’m a production potter who makes a lot of pots, so having the kiln just outside my studio door has saved me money—not in the short term—but in the long run. I spend more time in my studio and less time loading pots into my car and driving to my kiln. It goes without saying that I save a lot of gas as well. Besides, customers are impressed when you can give them a tour of the kiln. They love knowing the pot they are buying was just glowing red a few days ago. If you think it through and do your research, you can have your gas kiln without having to move out of your favorite urban area.

Kerry Brooks can be reached at: dock6pottery.com

A Front-Yard Kiln by Robert Klander

Early in the year of 2007, Arnold Howard of Paragon Industries made an announcement on the Clayart listserv (*potters.org*) that a number of pallets of surplus new soft brick were available for a very reasonable price. I was instantly interested, and made the deal for a couple pallets of these bricks—K23s.

The Research

I struck up a conversation with Mel in the Clayart room back at the NCECA conference. It was a “what can you tell me that will convince me I can do this” kind of conversation. I had asked the right person, because, within a short time Mel had convinced me that, not only was it something I could do, it was something that just about anyone could do, successfully! We talked about Minnesota flat-top kilns, we talked about flue designs, we talked about burners. Kurt Wild entered the conversation at some point, assuring me that everything that Mel was talking about, and all of the design ideas that had been publicized by Nils Lou in his book, *The Art of Firing*, did indeed work.

Both men stressed the exit flue design as being the most crucial element to an even firing in a fuel kiln. The dimensions of the ware chamber didn’t matter that much—it didn’t have to be a cube, it could be taller, deeper, whatever. Mel likes the Minnesota flat-top design because the flat-top is easier to construct than an arch—no special bricks or cuts needed. A sprung arch would work fine, too, just keep that flue to the specs in Nils Lou’s book.

When I got home, I immersed myself in *The Kiln Book*, while awaiting the arrival of *The Art of Firing* that I ordered straightaway. I read everything a couple of times. I searched online and in other books for ideas until the bricks arrived.

The Location: The Front Yard

I decided to locate the kiln in the front yard of my property. It was relatively flat, and there was a paved drive there, so deliveries of clay and propane would be convenient. We situated the pad at an angle to the drive, with enough room to accommodate a building that would house the pottery just behind it, parallel to the property line.



Robert Klander's arch-top kiln.

The Pad and Shed

We poured the pad in October. The new studio showed up in January of 2008, and the power got turned on a month later. I ordered an instant carport for the kiln shed, but we had to close in the ends around the doors with metal studs and T-111 plywood siding. Turned out that the floor of the shop and the pad were dead level to each other, so it made sense to build a deck between the two, which made the moving of pots and

materials a much easier proposition, as we could use wheels for everything!

The Kiln

Once the construction of the shed had been completed, it was time to get onto the building of the kiln. I designed the dimensions to accommodate two stacks of 14" x 28" shelves. I was urged to leave room for a bag wall, just in case I had glazes that would not stand flame impingement.

The local tech school has a bricklayer program. So, after a short discussion with the instructor, he agreed to cut a quantity of the K-23s into arch brick to build a sprung arch for the ceiling. He would not accept a fee but was happy to accept a donation to his program.

Designing the Arch

A nearby potter friend, Gary Shaffer, helped me work out some of the other details. He suggested that I purchase some K-26 IFBs for the hot face of the flame path and the lower half of the interior walls. He also described how he arrived at the arch curve: 1) Lay out a straight line on a piece of newsprint. 2) Mark two points the distance between the top inside corners of the top row of bricks along that line. 3) Decide the rise of the arch. 4) Plot the curve either with trammel points, or with a flexible board, such as a narrow strip of ¼" plywood, or door skin. 5) Then, just lay out the arch bricks to the line, and make a note of the order, so that once the arch form was in place, the arch bricks would go up easily.

Cutting the Frame

Arrangements were made with a local welder to get the steel cut to length for the corners and

for the sides. We cut 1" pipe into 3" sections, and welded them at the top and bottom of the corner angle iron for the tie bars to pass through. The tie bars were heavy duty ¾" rebar with 3" of all-thread bar welded to each end. They were long enough to accept a valve spring (from the local engine shop's junk pile), a washer, and a nut at each end. The valve spring allows for some expansion of brick during firing, so that the inevitable fractures that occur could be postponed as long as possible.

The welder also fabricated a steel door and hinge arrangement that hangs off of a post bolted to the slab, and is supported by one wheel on the far side of the door. The door was then lined with one layer of ceramic fiber board, and 6½" of firebrick.

Making the Stack

Mel suggested that the best chimney stack he's ever had was 12" spiral pipe (used as interior duct work in HVAC commercial applications), lined with 2600° riser sleeves (used in foundries). Again, I took him at his word, and found a ten foot length of it at a local HVAC contractor. I found the riser sleeves at the nearest foundry supply. The chimney went up in less than two hours, including cutting the hole in the shed roof, and fashioning a "roof boot" to waterproof the pass-through.

Firing it Up

We had our first firing just recently, and the kiln did a wonderful job. There was maybe a half-cone difference from top to bottom, if that. We are very happy with this outcome. Everything worked just as we were assured it would—maybe even better than that. We are so grateful for the guidance and encouragement from Mel Jacobson, Gary Shaffer, Kurt Wild, Vince Pitelka, and so many other members of the Clayart listserv. Their tested, valid, up-to-date information has saved countless hours of building mistakes that might have occurred otherwise.

Gary Shaffer, Anne Tamea, and I put the walls of the kiln up in an afternoon. Anne, her son Dan, and I put the arch together in an hour or two, with the longest task being to cut the key bricks to fit. Brad, the welder, managed to fabricate the steel, door and hinge in about 10 hours. Ryan and I were able to get the door lined with brick and lock it in tight in about 6 hours, including the time it took Anne and I to cut the 164 bricks to the right size.

To everyone considering building a kiln: It's doable. Use the plans for Kurt Wild's kiln and modify them to fit your needs. You too can have the kiln of your dreams.

*Robert Klander can be reached at:
turtlerockpots.com*

Bob Fritz's Kiln

Bob built his flat-top kiln using Nils Lou burners within a very nice kiln shed just off his garage. He also has a complete studio building.

Bob bought used Advancer shelves, and did not know that several of them were stored “damp.” At least one of them exploded in one of his early firings—almost destroying his kiln. That first kiln fired in about four and a half hours. It was a perfect propane-fired small gas kiln. In the movie of his kiln you can see the unique system he used to support the kiln with cable and bolts running through angle iron.

After his explosion, he rebuilt the kiln using a low arch system. Bob is experienced in arch building and preferred an arch. It gave him just a bit more space in the kiln.

The door is free stacked. Bob is very well organized and has numbered the brick so he can stack that door perfectly every time. (Door stacking in an arch can be difficult if not organized properly.)

His new configured kiln fires in about 6 hours+ with very even reduction. It is without doubt that Bob's kiln fires with beautiful results every



photo: Bob Fritz

Bob Fritz's home-built kiln.

time. He is very pleased with the size, the firing accuracy, and the ability to fire often.

Bob is a professional teacher and potter. He has an MFA from Cranbrook and has taught both college and high school. He makes a very fine line of functional pottery. His skill level is extremely high.

*Bob Fritz can be reached at:
New Earth Pottery, Ellsworth, Wisconsin*

5 KILN STORIES: AN ARCH-TOP SODA KILN

Building the Appalachian Center for Craft 21-Cubic-Foot Cross-Draft Soda Kiln by Vince Pitelka

This is a tried-and-true design for a simple, LPG-fired cross-draft soda kiln of 21-cubic-foot displacement and approximately 16 cubic feet of stacking space, designed for two 12" x 24" silicon carbide shelves on each level. The narrative and accompanying plans include most of the information you need to build this kiln, but they also assume a general knowledge of kiln construction. You may need to get a copy of my book, *Clay: A Studio Handbook*, and/or Fred Olson's *The Kiln Book* to provide necessary information about kiln building.

Note regarding the kiln plans: The plans were done in Microsoft Paint, which does not allow for much adjustment of size, thus the scale is only approximate—one inch on the drawing equals approximately one foot on the actual kiln. Everything is otherwise to scale, but the indications of individual brick placement are generalized. It is important to consult the section on kiln construction in the books mentioned above, specifically regarding the

building of the stretcher and header rows in the kiln walls. Adjustments must always be made when placing bricks at the corners and around the burner ports and flue in order to minimize the alignment of seams in each layer.

Also note that the kiln uses IFB (insulating firebrick) on the outside wherever possible—everywhere except the header courses (which pass all the way through the wall and therefore must be hard brick) and the bricks that surround the burner ports, charging ports, accessory ports, door, and flue, which are all hard brick.

The Hot Face: Hard Brick versus IFB

After working with a series of soda kilns that were at least partially IFB on the interior, I have come to the conclusion that it is not feasible to use IFB on the hot face of a soda kiln that is going to receive fairly heavy use. In several previous soda kilns at the Appalachian Center for Craft we experimented with an IFB hot face sprayed with ITC-100 thermal coating, and those kilns lasted 150 to 200 firings before needing a rebuild. With the frequency of our

soda firings, that isn't enough. Rebuilding a kiln is expensive and time consuming, and I want a soda kiln that will last at least five years before rebuild. We get that kind of life with a hard brick hot face, and the accompanying plans are for such a kiln.

Building this Kiln with an IFB Hot Face

Considering the price of fuel, if you will only be firing your soda kiln once or twice a month, you may wish to use 2600° IFB for the hot face except for high-duty hard brick in the high-stress areas like the floor (upper layer only), firebox, bag wall, and the ports, flue, door sill, and door. If you are confident of your ability to treat IFB gently in loading the kiln and stacking the door, and in removing and replacing spy hole plugs, you can use IFB in some of those areas as well. The floor, bag wall, and firebox walls up to the top of the bag wall must be hard brick, and the burner ports, charging ports, and flue must be hard brick for the full thickness of the kiln walls.

The brick list at the end of this narrative is for a hard brick hot face. If you decide to build your kiln with an IFB hot face you will have to extrapolate from the plans and brick list in order to figure how many 2600° IFB to substitute for hard brick. All IFB on the outside layer should be the less-expensive 2300° brick.

Spraying the Hot Face with a Vapor Barrier

If you build this kiln with IFB, spray the entire interior with a thin saturating coat of ITC-100. Don't build it up at all—just soak the surface. On our current kiln, we sprayed the hard brick hot face with ITC-100, but with an all-hard brick salt or soda kiln I have come to believe

that it is just as effective to spray the hot face with a thin saturating coat of any cone 10 shino glaze. This will help seal the surface from the start to reduce sodium vapor penetration into the brick, and it's similar in composition to what will accumulate on the hot face with time, anyway.

The Foundation

The kiln is elevated on a single layer of cinder block (with holes facing upwards) to reduce back strain during loading and unloading. In order to get the configuration of block you need, use any combination of available cinder block sizes, including standard block, half block, narrow block, and the solid cap blocks standing on edge. A layer of cement board on top of the blocks provides a smooth surface upon which to lay the brick. The cement board can be cut with an abrasive blade on a skill saw. Be sure to wear appropriate safety goggles and respirator.

The Kiln Floor

The kiln floor is composed of two layers of IFB (we used a mix of new and used, whole and broken) followed by a layer of high-duty hard brick as the hot face floor to withstand the abrasion and soda attack and support the weight of the set. This kiln is all dry stacked. No mortar is used anywhere in the construction.

Note: When laying the floor, be sure to leave a ½" space front to back in the bottom layer of IFB where the kiln floor meets the chimney floor, to allow a piece of ¼" x 2" steel flat bar to be slipped through flush with the outside wall of the kiln as the lower left cross-member on the steel frame. (See the Steel Frame section for more details.)

The Walls

As mentioned, this kiln is dry stacked with no mortar. If you are building with a hard brick hot face and encounter a slight discrepancy in height between the hard brick and IFB, you have two alternatives. If the IFB are higher, set several hard brick on a flat surface with an IFB between them, and use another hard brick or a piece of cinder block to abrade the surface of the IFB down to the height of the hard brick. This is tedious, dusty work (wear a respirator), but may be necessary. If the hard brick are higher than the IFB, you can apply a thin skim of mortar on the IFB to adjust the height as you build up the walls. If so, use a mortar of 40 parts fireclay and 60 parts extra-fine grog. Moisten the brick surfaces with water, and apply the mortar very sparingly. This should only be done on the outside layer. If you use this mortar on the inside layer it will shrink in firing, leaving gaps that allow sodium vapor penetration into the walls.

The walls are 9" thick (a standard brick is 9" long x 4½" wide x 2½" high), and are built from a mix of header and stretcher courses of bricks. Each header course will begin and end with a soap, a brick that is as long as a standard brick but half as wide (9" x 2¼" x 2½"), in order to minimize alignment of seams with the layers below and above. Adjustments must be made in laying bricks at the corners and over the burner ports and flue, and alignment of seams should be minimized at all times in order to get the strongest locked wall.

The Burner Ports and Flue Opening

The burner ports, flue opening, and chimney must be accommodated as soon as you start



photo: Vince Pitelka

Vince Pitelka's arch-top soda kiln.

laying bricks on top of the floor level. The burner ports are at floor level and are 4½" wide (½ brick) and 5" high (2 bricks).

Remember that the flue opening and burner ports are all lined with hard brick through the full 9" thickness of the walls. When laying the left side wall, the chimney must be constructed simultaneously, so as to tie the bricks in with the side wall.

You will need to cut hard brick to produce half bricks, and will need to do some custom cutting to accommodate the spacing of the three burner ports. Use a brick saw if possible, but if you do your cuts with a hammer and brick chisel, plan your chisel cuts so that they are not exposed within the flue and burner ports. In either case, wear appropriate safety goggles and respirator.

As shown on the plans, the flue opening leading to the chimney is 9" wide x 7½" high (3 bricks), and you can bridge this with two hard bricks

meeting at the center, with a larger refractory piece, or with a custom piece made from commercial castable refractory.

The Chimney and Damper Slot

The chimney is 9" x 9" inside, and is hard brick to one brick above the flue opening, and IFB to just above the top of the arch. At that point you can change over to steel pipe, such as inexpensive galvanized iron culvert. The chimney should extend a minimum of 8' above the top of the arch, no matter what kind of burner system you use. On a normal oxidation or reduction kiln equipped with power burners, the chimney could stop right above the arch, but in a salt or soda kiln you need the convection-tower effect of the chimney to pull the sodium vapor through the set in order to allow maximum flexibility in firing effects.

When you get to the appropriate level for the damper slot, as indicated on the plans, you need to accommodate this rather specialized and precise feature. In all the years I have been designing and building kilns, I have come up with only one satisfactory system, but it works very well. Purchase several new $\frac{3}{4}$ " mullite or high-alumina kiln shelves of any square or rectangular shape, and one new 1" mullite or high-alumina kiln shelf of any square or rectangular shape. The shape does not matter, because you will be using an abrasive or preferably diamond blade on a skill saw to cut strips from these shelves. It is important to use a new shelf, because a used shelf will be very difficult or impossible to cut. If you saturate the shelf with water and wipe off all excess water before cutting, the saw will cut easier, with less dust. Depending on the hardness of the shelves and

the type of saw blade you use, it may be difficult to cut through the whole thickness of the shelf. If you encounter this problem, just make a shallow cut on each side of the shelf at exactly the same spot, and then tap along the shelf with a small hammer. If you do this carefully, the shelf will break along the cut.

Since the chimney shares the side wall of the kiln, the layers of bricks must continue to line up horizontally as you build the damper slot. One brick is 2½" high. By using shims made from these kiln shelves, you will lay a course of $\frac{3}{4}$ " shims, a course of 1" shims that creates the damper slot, and then another course of $\frac{3}{4}$ " shims, totaling 2½". Note that this shim system is not indicated on the plans.

The first course of $\frac{3}{4}$ " shims is 4½" wide and extends all the way around the chimney. You can cut the $\frac{3}{4}$ " shim pieces to the size of bricks (9" x 4½"), or if the shelves you use are large enough, you can cut four 4½" x 13½" pieces.

On top of the first layer of shims, lay a course of 1" shims that are 3¾" wide around three sides of the chimney, leaving a $\frac{3}{4}$ " ledge on top of the first course of shims on the inside of the chimney. Lay these shims only on the front wall, right side wall (the kiln wall) and back walls of the chimney, leaving the damper opening on the left side as you are facing the front of the kiln. On top of the 1" shims, lay another course of $\frac{3}{4}$ " x 4½" shims all the way around the chimney, and lay them to minimize alignment of seams with the previous layer. With this layer of shims you will need to cut a 4½" x 18" x $\frac{3}{4}$ " shim to span the damper opening. That's a little risky, though, and with

time it may crack from the weight of the bricks above it, so a far better solution is to cast a custom piece from hard castable refractory that is 18" x 4½" x 5¾" high and use it in place of the strip of ¾" kiln shelf and the next two courses of bricks on the side of the chimney above the damper slot. Otherwise, once you get above the damper level, continue with all IFB.

The point of this system of shims is to create a durable, abrasion-resistant slot 1" high and 10½" wide to accommodate a damper that is ¾" thick and 10" wide. The damper can be either silicon carbide kiln shelf or mullite, but in either case keep a close watch on the condition of the damper, looking out for any warpage or cracking, and replace the damper at the first sign of damage.

When you get above the level of the arch, you can switch over to steel pipe as mentioned above, but you will need a flange and collar to match the pipe to the brick chimney and support the weight of the pipe. Purchase or cut an 18" x 18" square of steel plate with a 9½" hole in the center. Weld on a 9½" outside-diameter vertical collar 2" tall, fabricated from 2" steel flat bar. The 10" inside-diameter steel pipe or culvert chimney extension will fit over this collar. Make sure to get your piece of pipe or culvert first in order to assure that the vertical collar will fit inside the pipe. The pipe extension will have to be replaced periodically due to the corrosive exhaust gases, but the price is still minimal compared to the time and expense required to build an all-brick chimney.

The Charging Ports and Spy Holes

Be sure to note the placement of charging ports in the front and back walls of the firebox, plus

the four spy holes in the back wall. The charging ports should be 4½" wide and 2½" high in order to allow easy access with the metal spray wand of the garden sprayer. The spy holes should be 2½" square, and the simplest way to make spy hole plugs is to fashion them from IFB with a taper so that they sit securely and snugly in the spy holes. There are obviously more spy holes than are needed for your cone packs, but they can also serve as charging ports for those wanting heavy surface effects on particular pieces. The charging ports and spy holes are lined with hard brick through the entire thickness of the kiln wall.

All charging of soda solution is done through the main charging ports directly into the firebox, or through the smaller ports in the back wall or the door. Avoid charging through the burner ports under any circumstance, as it will result in rapid deterioration of the burner ports and corrosion of the main burners and pilot burners. The charging ports are provided specifically to introduce soda solution into the firebox. These ports are located low down, so that the direct impact of soda solution is confined to the hard brick hot face surfaces of the floor and adjacent wall.

When building the walls, proceed right up to the level of the skew bricks on the side walls, but leave the back wall and the partial front wall one brick lower until after installing the arch. You will partially support the arch form on these surfaces, and you need that additional brick height to install shims and wedges to support the arch form.

The Steel Frame

Once the walls are completed up to the level of the skewers, it is time to build the steel frame, since the arch cannot be sprung until the frame is in place to absorb the outward thrust of the arch. You will need to refer to Olsen's *The Kiln Book* or to *Clay: A Studio Handbook* for specifics about building kiln frames.

A steel frame is essential on any sprung-arch kiln to absorb the outward thrust of the arch. On a salt or soda kiln a sturdy welded frame is important because, with time, such kilns start to move. In the high-stress areas, brick become saturated with flux and expand, and a frame helps to keep everything in place. The frame is standard mild-steel stock arc-welded at all joints. The corner verticals, front upper and lower cross-members, the arch-buttressing cross-members, and the front vertical to the right of the door are all $\frac{1}{4}$ " x 2" x 2" angle iron. The lower right-side cross-member is also the burner support, and is $\frac{1}{4}$ " x 4" x 4" angle iron. The other cross-members are $\frac{1}{4}$ " x 2" flat bar.

Note that on the sides there are three cross-members, because of the inclusion of the arch-buttressing cross-members. I believe in having continuous cross-members all the way around the top of the frame to help stabilize everything. Those members are flat bar on the sides and back, but angle iron on the front, because it needs that rigidity to support the angle-iron vertical to the right of the door. The bottom cross member on the front is also angle-iron, to serve as a door-sill reinforcement, and because it requires rigidity for the same reason as the upper front cross-member.

The angle-iron cross-member beneath the door and the one that supports the burners serve as lower cross-members on those two sides. On the back side, the flat bar lower cross-member should be placed at the same level as the front lower cross-member.

Note: On the left side, the lower cross-member (flat bar) must be placed below the floor level to get it away from the hot face where the flue passes into the chimney. When laying up the floor on top of the cement board, you should have left a $\frac{1}{2}$ " gap front to back where the kiln floor meets the chimney floor in the first layer of IFB to accommodate the left cross-member. When you build the steel frame, you will need to slip a piece of $\frac{1}{4}$ " x 2" flat bar through this gap so that it lays on edge flush against the outside wall of the kiln to serve as a cross-member on that side, connecting the left-front and left-rear vertical corner angle-iron members.

The vertical angle-iron member to the right of the kiln door is very important. This is a high-stress area, and without that vertical, the stub-wall will often warp or lean outward with time.

Note that the plans show placement of the burner-support cross-member so that its upper surface is one brick below the burner ports, in order to protect it from excessive heat exposure.

Note that the left-hand buttressing angle fits directly up against the skew bricks inside the kiln wall, with short flat bar braces connecting it to the corner angles outside the kiln. It is thus hidden from view inside the kiln wall when the kiln is completed. Normally, this cross-member

would be placed outside the kiln wall as with the other cross-members. In this design, the kiln and chimney share the same 9" wall. If the cross member were on the outside of the kiln wall it would be exposed to the heat and corrosive flue gases inside the chimney and would fail quickly. In this design, it is inside the kiln wall, spaced away from both the kiln hot face and the chimney interior.

The Arch

This kiln features a 4½" hard brick arch plus a 4" layer of castable insulating refractory, with a single thickness of aluminum foil separating the two. The arch extends the full distance from the outside front face to the outside back face of the kiln, and the kiln is five bricks deep front to back on the outside.

This kiln is four bricks wide inside, which is 36". Using the specifications in the *A.P. Green Pocket Refractory Handbook*, an ideal 36"-span arch for this kiln has a rise of 2.3" per foot, a center rise of 6¹⁵/₁₆", and an inside radius of 2' 1⁵/₁₆". This arch requires 18 #1 arch bricks and 1 straight brick from one side to the other to get the appropriate curvature and span. That means 18 front-to-back rows of #1 arch bricks and 1 row of straight bricks.

Building the Arch Form

The arch form is a temporary structure that supports the arch while the bricks are laid. Be sure to save your arch form, because you will use it again eventually. When the kiln needs to be rebuilt, there is no graceful way to take down an arch other than to put the same form in place and jack it up under the arch.

To build your arch form you will need a sheet

of ¾" plywood, one 8-foot 2x4, a sheet of Masonite or some other similar, flexible sheet material, several dozen 3" drywall screws, a box of 100 one-inch drywall screws, and a yardstick. It will also help to have two electric drills—one for drilling pilot holes and the other for installing the drywall screws.

The flexible sheet provides a smooth, sturdy curved surface over the plywood ribs, and before proceeding you must subtract the thickness of this material from the radius given above, so that your finished arch form will come out with the correct radius. Assuming you are using ¼" Masonite, the corrected radius for making the ribs would be 2' 2¹³/₁₆".

You can easily adapt the yardstick to serve as a compass to make the ribs for your arch form. Drill a pencil-size hole near one end and affix a pencil. Measure exactly 2' 2¹³/₁₆" and install a drywall screw protruding from the same side as the point of the pencil.

Near one edge of the plywood sheet, draw an arc with this compass. With the yardstick, measure a point across the arc that is exactly 36" and draw a line. This gives you an idea of the size of each rib, and you can now reposition if necessary to make the best use of the plywood. Cut out the first rib and use it as a template to make four more ribs. Six inches in from either end of the straight edge of each rib, cut a notch the size of a 2x4 (remember that the standard 2x4 is actually 1½" x 3½", but measure yours to be sure).

The arch is five bricks deep from front to back, which is 45". Cut two 45" pieces of 2x4, and fasten them in the notches of the ribs with 3"

drywall screws. Drill a pilot hole in each case to prevent the plywood and the 2x4s from splitting. When this assembly is done and sitting upright on the ground, the two 2x4s will be laying parallel inset into the notches in the plywood ribs, and the ribs will be standing vertically, one placed right at each end of the 2x4s, and the other three ribs evenly spaced between, creating a series of curves corresponding to the underside of the arch.

Carefully measure the length of the curved edge of one rib, and cut a piece of Masonite to this length and 45" wide. Some Masonite is quite hard, and you may need to drill a pilot hole for each screw as you proceed. Starting at one edge of the curve, attach the Masonite to the ribs with 1" drywall screws. This will require two people, one bending the Masonite tightly against the curve while the other one drills holes and installs the screws.

With good quality plywood and with screws installed as close as possible to the ends of each rib, it is possible to hold the Masonite tightly against the ribs even at the ends. If this proves problematic, a solution is to inset a piece of 2x2 stock parallel to the 2x4s in notches at each end of each rib and trim one edge to conform to the curve of the ribs in order to provide a front-to-back support to attach the edge of the Masonite with a row of 1" drywall screws.

Placing the Arch Form and Laying the Arch

The arch form will be supported by the back wall of the kiln and by the front stub-wall on the right, but on the left you will have to build up a temporary support with cinder blocks and

bricks. In all cases, you will achieve the final level for placement of the arch form by using wood shims and a set of four wood wedges. The wedges should be 6" long and should taper from 1" to ¼" over that length. Do not taper the wedges down to a knife edge, because you need a flat surface to drive them out in order to "spring the arch." Once the shims and wedges provide support at exactly the height of the side walls below the skew bricks, set the arch form in place.

Lay the arch from both sides simultaneously and work towards the center, beginning and ending every other course with a half brick in order to stagger the seams and produce a locked arch. If any brick are trimmed, be sure to brush or blow off all dust, preferably with compressed air. If you neglect this, the dust will inevitably sift down on wares being fired.

When there are multiple rows of straight bricks in an arch, we normally space them evenly among the rows of arch bricks. In this case, there is only one row of straight bricks. If you were building with IFB, you could simply leave that row until last, and trim the bricks to serve as a keystone row. With hard brick, a much more sensible solution with this particular arch configuration is to omit the row of straight brick, build the arch from both sides until you get to the center, screw a flat board to the arch form at each end so that it sticks up and covers the ends of the gap, line the gap with plastic wrap, and fill with high-duty castable refractory. The plastic wrap is essential in order to keep the adjacent bricks from sucking the moisture out of the castable and preventing it from air setting properly. All air-set castables must retain

their moisture while they set, which generally takes at least 24 hours.

It is important to realize that the charts provided in Olson's *The Kiln Book* or in any of the pocket refractory handbooks serve only as a general guideline. Things rarely come out exactly as predicted in those charts. As you are laying up the arch, you must observe the vertical axis of each row of arch bricks, looking at the end of the brick at the front of the row. The edges of each arch brick should be exactly on a radius of the circle. If the row starts to tilt even slightly towards the center of the arch, then you need to insert a row of straight bricks, regardless of what the specifications stipulate for that arch. You won't know the exact configuration until you lay up your arch.

Springing the Arch

Once the arch is constructed and the key bricks are snugly in place (or the castable key has air-set to maturity), the tapered wedges are driven out, which drops the arch form and "springs the arch." The wedges should be driven out a little at a time at all four corners so as to drop the arch form slowly and evenly.

The Insulation Layer Over the Arch

Since the arch is hard brick, the insulating layer is essential for heat retention, and it also provides critically important rigidity, lessening the flexing of the arch. That reduces the amount of material sifting down on the wares, and makes the arch last longer. However, for proper expansion and contraction of the two layers, they must not be bonded. This is easily prevented by laying down a layer of aluminum foil before adding the insulating layer.

There is no reason to pay the price for commercial castable insulating refractory for an external insulating layer over an arch. You can easily make your own insulating castable with a mixture of 40% sand or grog (builders sand, river sand, crushed scrap bisqueware, or crushed scrap IFB), 40% vermiculite, and 20% fireclay. For an arch exposed to the weather, reduce the sand or grog to 30% and add 10% Portland cement. If your kiln is in an open shed, you can use sawdust or crushed walnut shells in place of the vermiculite. This is only viable on a kiln in an open shed, because the combustibles will continue to create considerable smoke over many firings as they slowly burn out. Any of these mixtures without Portland cement will shrink considerably in drying. Just go back with the same mixture and fill the cracks until no more cracks form.

The Bag Wall

In some gas kilns, bag walls are not necessary, but they are almost always present in salt and soda kilns in order to provide a specific firebox area of maximum heat and turbulence to encourage effective vaporization of the salt or soda before it affects the wares, and to prevent the sodium vapors from hitting the wares too directly. Bag walls are necessary in gas kilns with side-mounted burners, in order to keep the flames from impinging directly upon the wares.

In a salt kiln, the bag walls must be constructed from hard brick laid flat, giving a 4½" thickness. Soda is less corrosive, and the bag walls may be constructed from hard brick laid on edge, giving a 2½" thickness. The brick should be laid with no gaps in the areas directly in front of the burners, but with gaps opposite the spaces between

the burners, and with plenty of gaps above the level of the burners. Since the burner ports are fairly closely spaced in this kiln, for the first row of the bag wall, bricks will have to be cut in order to position the gaps in front of the spaces between burner ports. For us, a bag wall three bricks high (13½") has worked well.

When building the bag wall, all contact surfaces between bricks and where they touch the kiln walls and floor should be coated with appropriate salt-soda shelf wash (40% EPK, 10% ball clay, 50% alumina). This will greatly simplify the inevitable occasional reconstruction of the bag wall.

The Stacked Door

This kiln is designed to have a loose stacked door 9" thick. The two courses should be laid simultaneously, with frequent bricks laid header-style, tying the two layers together. All contact surfaces on these bricks and the mating surfaces of the door jambs and arch should be coated with salt-soda shelf-wash, and with repeated firings should be recoated as soon as they start to stick together or show any soda accumulation. As you construct the door, be sure to leave appropriate spy holes for observing the cone packs and pulling drawings.

Build the door up to the bottom of the arch with all hard brick, and then use IFB wherever you have to shape a brick to fit the arch. When you coat the mating surfaces with kiln wash, also coat the inside surface of the IFB to make them last longer.

Once the stacked door is in place, all larger cracks or gaps in the exterior face should be

sealed with a caulking mixture of equal parts recycle slurry, sand, and sawdust, stiffened with dry crushed clay if necessary to get appropriate plastic clay consistency.

I recommend building a heavy-duty rack to accommodate the door bricks stacked in reverse order. This rack should incorporate a well-reinforced vertical or slightly back-tilted panel of ¾" plywood the size of the door, and a curved base extending from the lower edge matching the curve of the arch. As you unstack the door, place the bricks in order on this rack, and you will be ready to brick up the door efficiently the next time you fire. Such a rack drastically simplifies the task of stacking and unstacking a loose-bricked door.

The Burner Systems

We use a burner system with three GACO MR-100 venturi burners, available from Ward Burner Systems, equipped with BASO valves and target pilot lights. The MR-100 is a very reasonably priced venturi burner, and on high-pressure LPG with a pressure regulator at the kiln it produces plenty of BTUs. The regulator is located where the feed line from the tank reaches the kiln. After the regulator, the line divides into three, with a BASO valve and then a burner valve for each burner. It is not practical to show all the details of the burner system or give detailed instructions for assembly here, so once you purchase the main parts (burners, burner valves, BASOs, pilots, and pilot valves) from Marc Ward you may have to get some help in designing and assembling the rest of the burner system and plumbing.

With a hard brick kiln, this burner system must be operated on high-pressure LPG with an adjustable regulator, so be sure to specify high-pressure LPG when ordering the burners, target pilots, and BASO valves. This kiln with this burner system will not work on low-pressure natural gas unless you decide to do an IFB hot face as described above. If you do want to build this kiln with the hard brick hot face and wish to run it on natural gas, your only recourse would be to eliminate the center burner port, move the remaining ports in a bit towards center from the front and back walls, and install two Marc Ward power burners, which can be ordered in a configuration to deliver as many BTUs as you wish. If you build this soda kiln with an IFB hot face and are firing on LPG with an adjustable regulator at the kiln, you can get away with two burner ports and two MR-100 burners. On natural gas, this kiln with an IFB hot face would still require three ports and MR-100s, or two ports with two power burners.

The burner system should be assembled so that the face of each burner tip is about 1¼" from the face of the burner port. When the burner system is assembled you can temporarily support it in place with bricks and blocks while you finish the permanent support. **Under no circumstances should you rely solely on the plumbing for support.**

The burners are attached to the angle-iron cross-member with standard automotive muffler clamps, available from any auto supply store. You will need 3" ID clamps to fit around the tips of the MR-100 burners. The burner-support cross-member is 4" angle iron in order to extend far enough out from the kiln face to

allow installation of the muffler clamps, which must be spaced back from the burner tip far enough to protect them from excessive heat and corrosion.

When the clamps are assembled around the burner tips, the steel crosspiece portion of the clamp will be at the bottom, with the threaded studs pointing downwards. I tell you this just to visualize the position of the clamps, but before you assemble them, weld the heads of two ¾" x 4" bolts to the underside of the clamp crosspiece, just in towards the center from the stud holes so that the threaded shaft of each bolt points straight down. With the burner system blocked up in place, and with the clamps assembled loosely on the burner tips, mark and drill holes for the welded-on bolts in the burner-support cross-member. Place the clamps as far as possible from the burner tip while still within the range where the bolts can fit through holes drilled in the burner-support cross-member.

When you are ready to install the burner system, tighten the muffler clamp on each burner. Screw a ¾" nut all the way up each of the bolt threads, lower the bolts through the holes in the burner-support cross-member, and screw another nut onto the threads below the cross-member. By changing the position of these two nuts, you can control the height of the burner tips in relation to the burner port.

The burners should be centered in front of the ports both horizontally and vertically, and as mentioned, the burner tip face should be 1¼" from the burner port face. Once you have all the adjustments correct, tighten the nuts on

either side of the burner-support cross-member to lock the system in place. I recommend that you spray the burners, clamps, bolts, and nuts with a good high-heat aluminized paint, and re-spray them as soon as the paint shows sign of corrosion. The paint will burn off the burner tips almost immediately and you needn't worry that about, but if you re-spray the rest of the burner system and the bolts and clamps frequently you can significantly retard corrosion on these parts.

Brick List

This list includes all of the brick needed plus extras. If you are planning to incorporate used brick, subtract accordingly from these amounts. You only need a few of the soaps at the ends of the header courses to minimize alignment of seams with bricks above and below, but they are ideal 9" kiln posts for salt and soda firing, and I have included plenty of extra. Cut standard hard brick into fourths for 4½" posts, cut soaps into fourths for 2½" posts, and cut scrap kiln shelves into shims for fine adjustment of shelf height.

As mentioned earlier, this list is for an all-hard-

brick hot face. If you choose to build your kiln with a hot face that is partially IFB, you will need to extrapolate from the plans to determine how many IFB to substitute for hard brick. These brick are all the standard 2½" series, which refers to the height of the brick when it is laid in place, or to the maximum thickness (not width) of the arch bricks.

Steel List

This list includes the steel needed for the welded frame and the chimney adaptor where the steel pipe starts. There is extra of most types in order to facilitate cutting whole pieces rather than splicing scraps together. This is all standard milled steel.

*Vince Pitelka can be reached at the
Appalachian Center for Craft*

<http://iweb.tntech.edu/wpitelka>

Type of Brick	Size	Quantity
High-duty hard firebrick	#1 arch, 2½" series	100 pieces
High-duty hard firebrick	straights, 9" x 4½" x 2½"	650 pieces
High-duty hard firebrick	soaps, 9" x 2½" x 2¼"	50 pieces
High-duty hard firebrick	45-degree skew bricks, 2½" series	12 pieces
Insulating firebrick, 2300°	9" x 4½" x 2½"	425 pieces
High-duty castable refractory (for casting the key at top of arch and for damper-slot lintel in chimney)		200 lbs dry-mix (mix strictly according to manufacturer's instructions)

Steel Stock Type and Size	Amount	Application
¼" x 2" x 2" angle iron	60'	Corner verticals, front upper and lower cross-members, door sill vertical, arch buttressing cross-members
¼" x 4" x 4" angle iron	4'	Burner support cross-member — also acts as right side lower cross-member
¼" x 2" flat bar	30'	Rear upper and lower cross-members, left side upper and lower cross-members, right side upper cross-member
⅛" x 2" flat bar	3'	Chimney adaptor collar
⅛" plate	1 pc. 18" x 18"	Chimney adaptor base plate

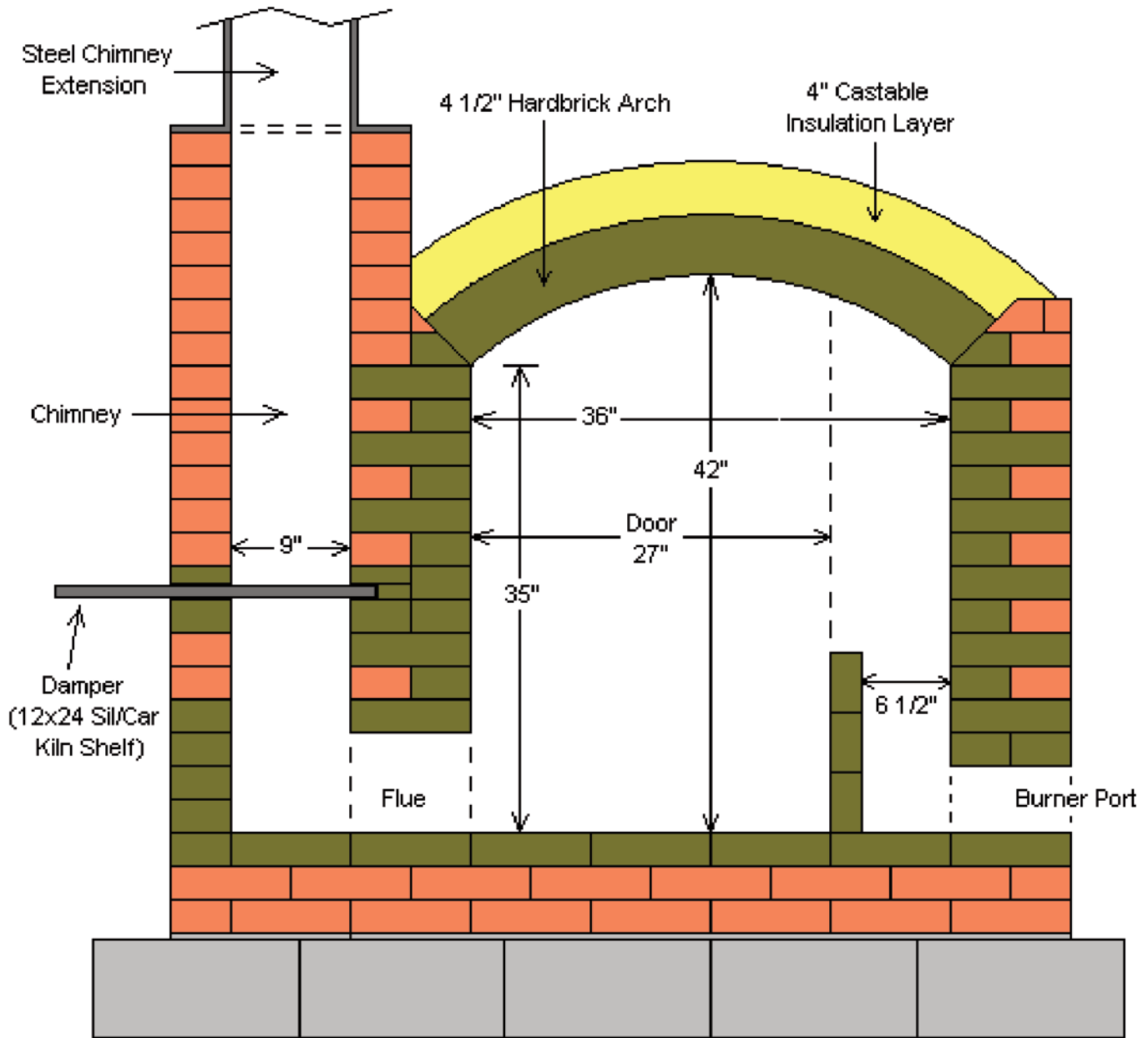

Downdraft, Crossdraft Soda Kiln
 Gas Fired, 21 Cu. Ft.
 16 Cu. Ft. Stacking Space
 Vince Pitelka, 2005
 Appalachian Center for Craft
 Scale - Approx. 12:1

Front Cross-Section View,
 with Dimensions, Showing
 Burner Port, Flue, Chimney,
 Bag Wall, and Damper

Color Key	
Hardbrick	Dark Green
Softbrick	Orange
Castable	Yellow
Steel	Grey
Cinderblock	Light Grey
Plumbing	Dark Teal

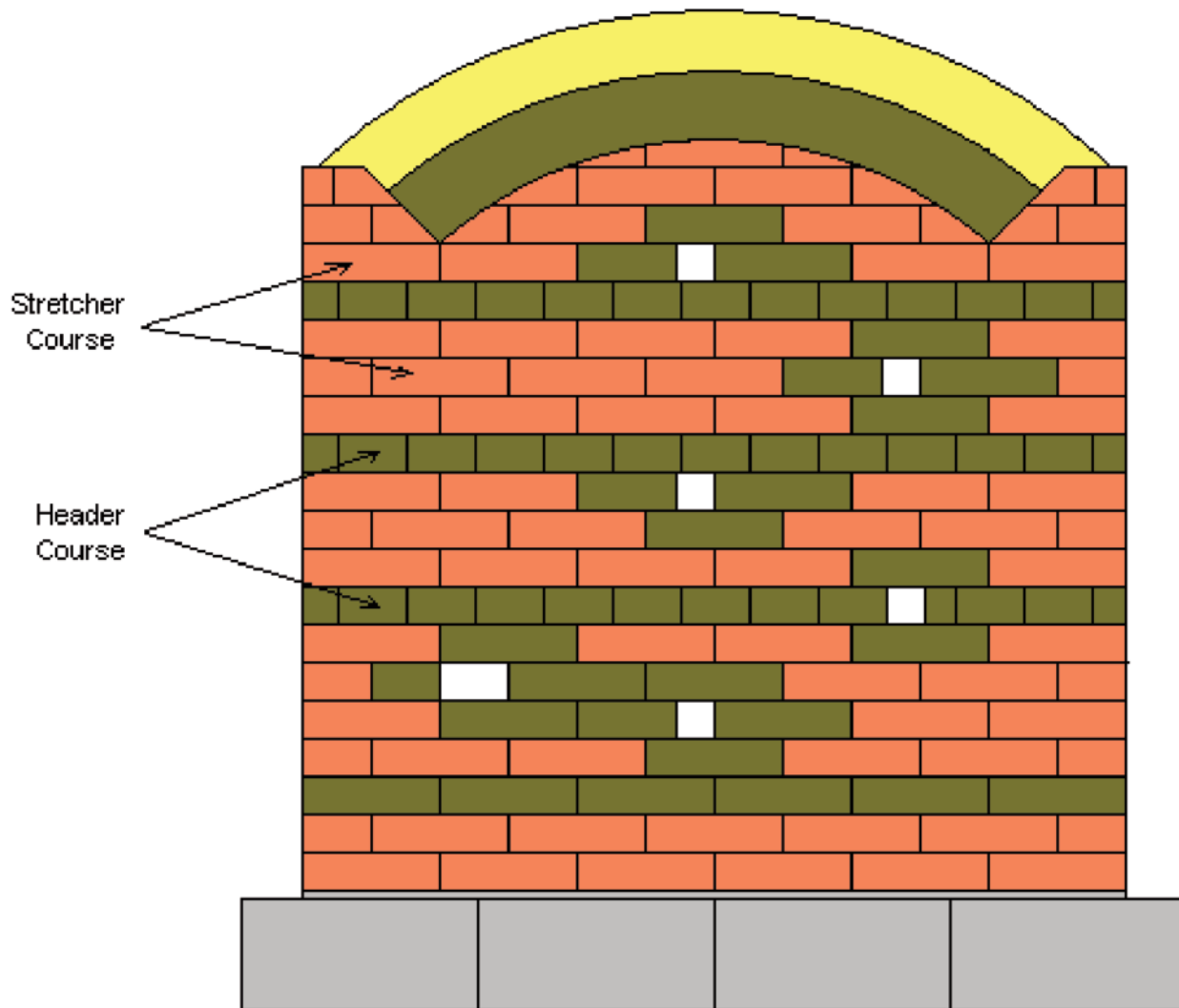

Downdraft, Crossdraft Soda Kiln
 Gas Fired, 21 Cu. Ft.
 16 Cu. Ft. Stacking Space
 Vince Pitelka, 2005
 Appalachian Center for Craft
 Scale - Approx. 12:1

Back View, Showing
 Charging Ports/Spyholes
 and Bricklaying Patterns

Color Key	
Hardbrick	-----
Softbrick	-----
Castable	-----
Steel	-----
Cinderblock	-----
Plumbing	-----

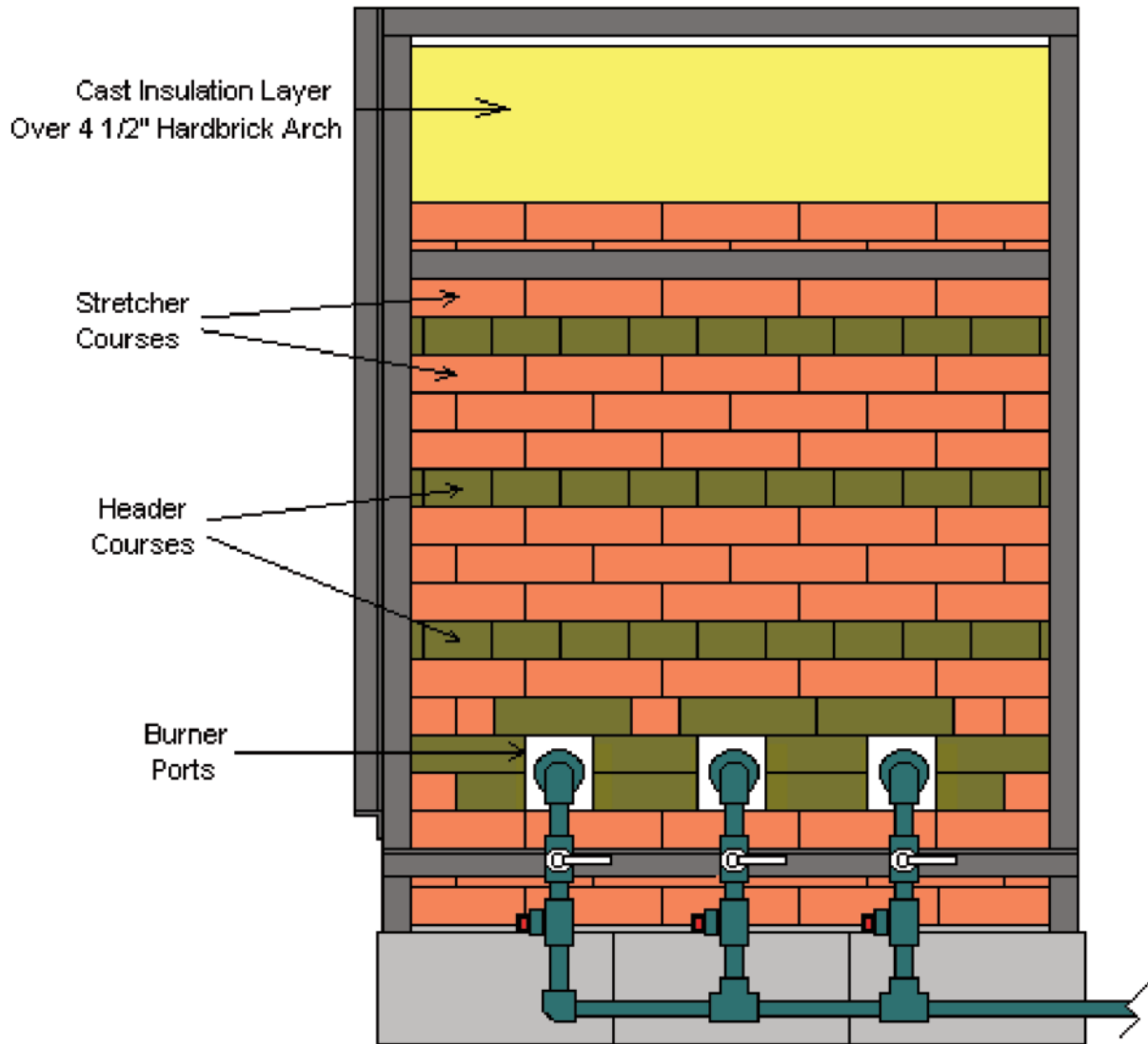

Downdraft, Crossdraft Soda Kiln
 Gas Fired, 21 Cu. Ft.
 16 Cu. Ft. Stacking Space
 Vince Pitelka, 2005
 Appalachian Center for Craft
 Scale - Approx. 12:1

Side View, Showing
 Burner Ports, Steel Frame,
 and Bricklaying Patterns

Color Key	
Hardbrick	Dark Green
Softbrick	Orange
Castable	Yellow
Steel	Grey
Cinderblock	Light Grey
Plumbing	Teal

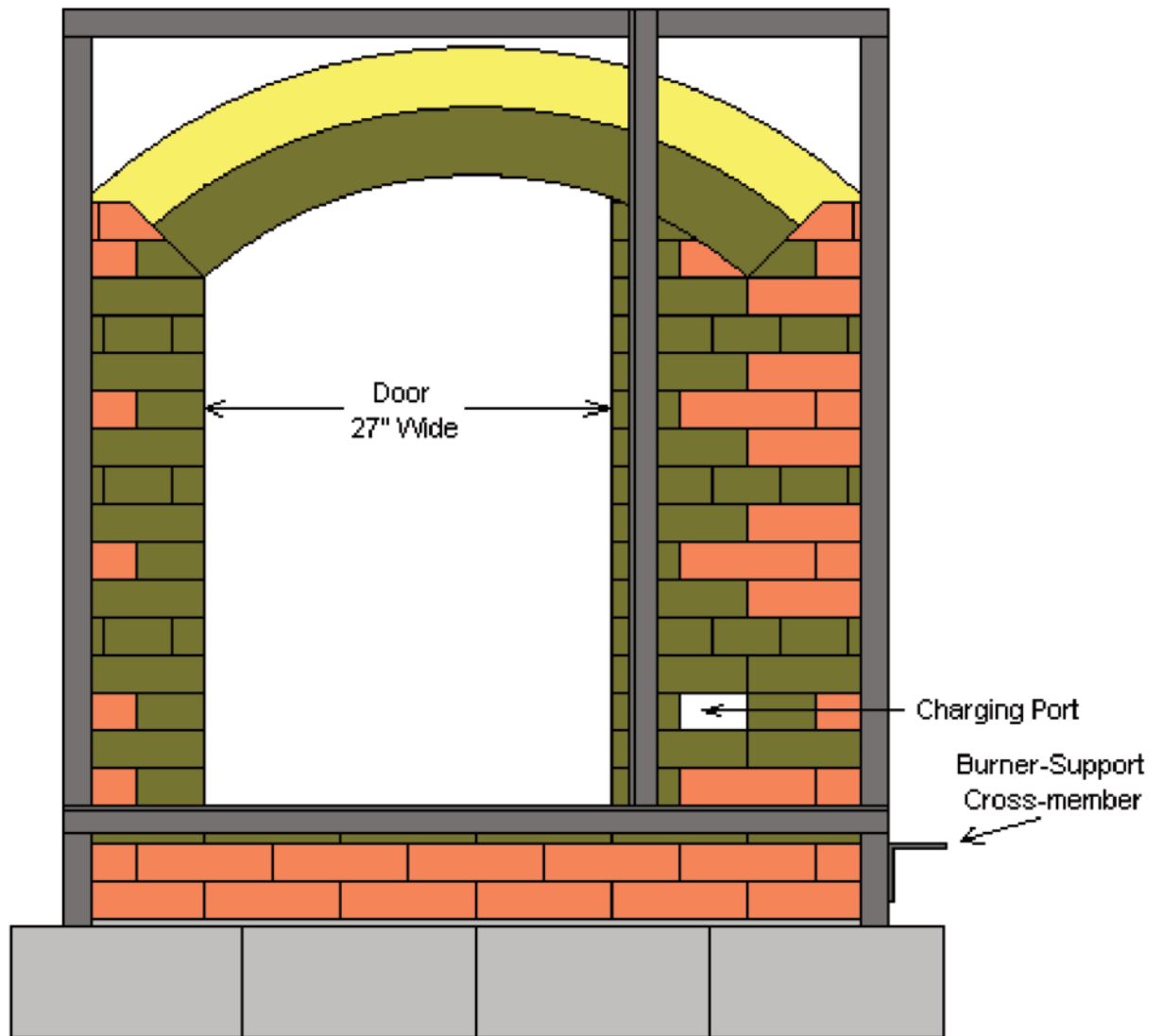

Downdraft, Crossdraft Soda Kiln
 Gas Fired, 21 Cu. Ft.
 16 Cu. Ft. Stacking Space
 Vince Pitelka, 2005
 Appalachian Center for Craft
 Scale - Approx. 12:1

Front View, Showing
 Door, Stub Wall, Charging
 Port, and Steel Frame

Color Key	
Hardbrick	Dark Green
Softbrick	Orange
Castable	Yellow
Steel	Grey
Cinderblock	Light Grey
Plumbing	Dark Teal

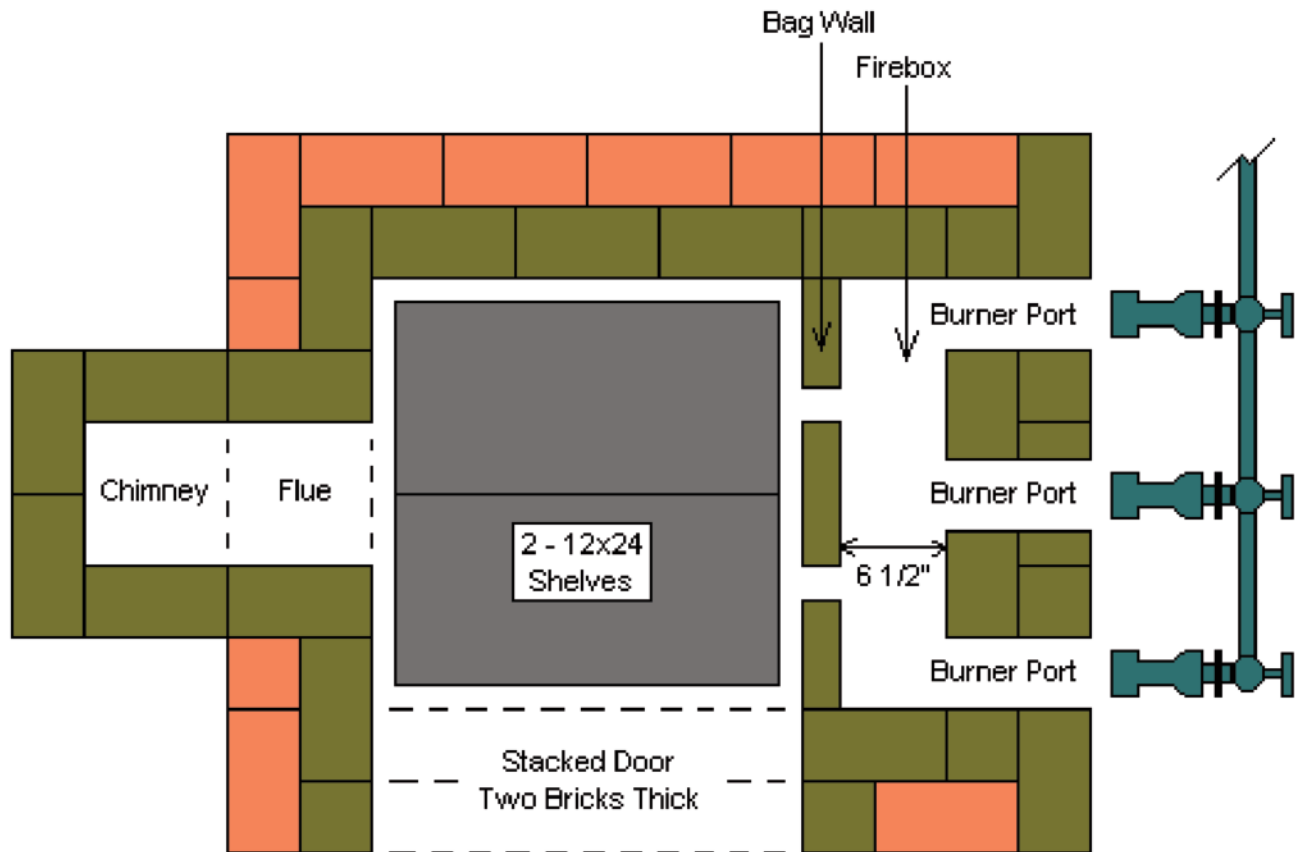

Top View at Floor-Level





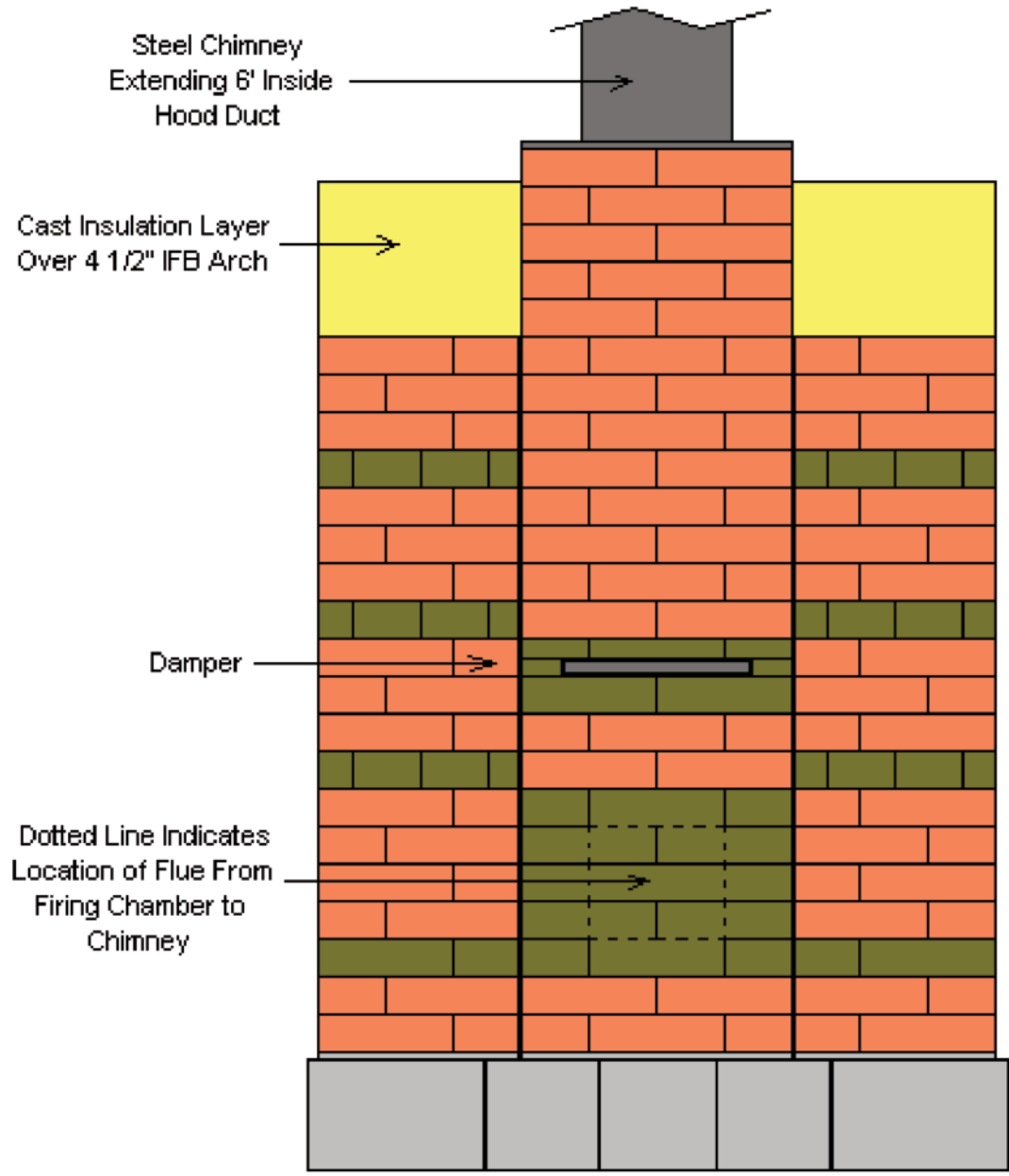

Downdraft, Crossdraft Soda Kiln
 Gas Fired, 21 Cu. Ft.
 16 Cu. Ft. Stacking Space
 Vince Pitelka, 2005
 Appalachian Center for Craft
 Scale - Approx. 12:1

Color Key	
Hardbrick	-----
Softbrick	-----
Castable	-----
Steel	-----
Cinderblock	-----
Plumbing	-----



Downdraft, Crossdraft Soda Kiln
 Gas Fired, 21 Cu. Ft.
 16 Cu. Ft. Stacking Space
 Vince Pitelka, 2005
 Appalachian Center for Craft
 Scale - Approx. 12:1

Side View, Showing Brick
 Chimney, Steel Chimney
 Extension, Damper, and
 Location of Flue

Color Key	
Hardbrick ----	
Softbrick ----	
Castable ----	
Steel -----	
Cinderblock --	
Plumbing ----	

6 KILN STORIES: KILNS WITH MOVABLE TOPS

Top-Hat Circular Ring Kilns Their Construction and Firing by Michael Wendt

Top-hat circular ring kilns are among the very easiest kilns to construct and, thanks to the counterweight and pulley system, they are by far the easiest kilns to load and unload. It is especially important to assess the kind of work you intend to make before you select this design, since the largest diameter pieces you can load will be 24". If your work is larger, other designs are better suited to your needs. With that single limitation in mind, be aware that even pots as large as the entire kiln displacement can be easily loaded, thanks to the low ledge height afforded by splitting the kiln body halfway up, plus the 360 degree access which allows helpers to assist in the lifting and placement of huge pots. Splitting the kiln halfway up also reduces the required ceiling height. The size and weight of the counterweight system makes stacking easier, since the lower half provides an easy visual reference for stacking the kiln shelves.

Kiln sizes up to 12 cubic feet are very simple to construct, requiring just a few simple tools and some ingenuity. When I first started doing pottery in 1973, the common wisdom among potters was to buy or build the largest kiln you could ever imagine the need for, and I made preparations to install a large car kiln once I had been making pottery a while.

Ring Kiln Advantages

To my surprise, these small ring kilns offered some distinct advantages over larger kilns and soon changed my mind about getting a huge kiln.

First, they are very fast firing, running cold to cold in twenty-four hours or less, allowing much more flexibility than a huge kiln that might be fired only once or twice a month and which takes days to heat and cool. This not only allows the user more frequent feedback on the firing process but also makes the order process much easier to accommodate. Product flow through the studio is faster, too.

Feedback on glaze experiments and mistakes also comes more quickly. Imagine an entire 100-cubic-foot kiln load ruined by a glaze mistake and then imagine the same scenario with a 12-cubic-foot kiln—the smaller kiln's advantage becomes clear.

At our peak in the mid-1980s we fired 24 kiln loads a month (using three top-hats) which yielded an average of 200 cubic feet per month. The nicest feature of this capacity is more apparent now when we fire only 8 loads per month of the 12-cubic-foot versions which total about 90 cubic feet per month. We still can fire twice a week, easily, to keep orders current.

Second, they are much cheaper to build and require much less furniture than a very large kiln. Moreover, since we have two that are the same design, they can share the same furniture, further saving expense. Additionally, high utilization rates mean a better use of capital when compared to the 40–100 cubic foot kilns so heavily touted by the majority of potters. Consider a \$3000 kiln fired 8–10 times a month with an average load value of \$1000: A \$3000 initial outlay returns \$8–10,000 per month while a \$12–15,000 large kiln fired twice a month still only returns \$8–10,000 per month.

Third, the smaller amount of floor space means a smaller kiln room, further saving cost.

Layout and Construction

First, a diameter is selected. Most people choose either 23½" or 28½" inside diameter. The smaller size requires 10 bricks per ring so the included angle is 36 degrees per brick (360 degrees / 10 bricks = 36 degrees per brick). The



photo: Michael Wendt

Michael Wendt's top-hat kiln.

larger size requires 12 bricks per ring so the included angle is 30 degrees per brick (360 degrees / 12 bricks = 30 degrees per brick).

Drawing a 12-Brick Template

This method uses the fact that a circle can be easily divided into 6 equal parts by using the compass setting that drew it. You'll strike a series of arcs starting anywhere on the edge of the circle and advancing the pivot to the crossing points created by these strikes. You'll do this until you have gone all the way around the circle, dividing it into 12 parts. Try this first on a sheet of paper so you can clearly understand what you are about to do.

The reason we use this method to create the pattern board rather than a protractor is accuracy. The compass method is absolutely accurate when performed correctly. In contrast, a protractor, especially a small one, generates parallax errors that add up to a rather poor result on a project this large.



photo: Michael Wendt

STEP 1 Construct a compass made of the sharp pencil, the nail and the wire wound as shown.



photo: Michael Wendt

STEP 4 Use a straight edge to draw a single line that passes through the center. Mark the two places it crosses the circle.

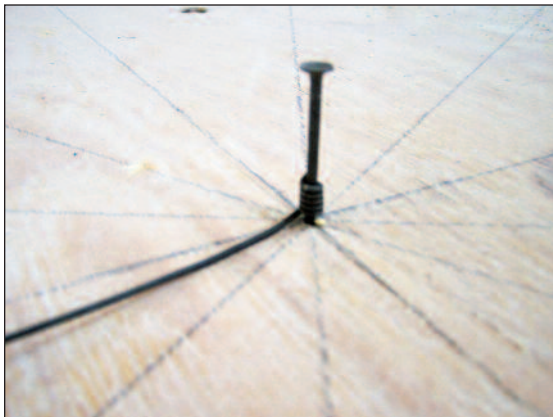

photo: Michael Wendt

STEP 2 Set the nail at least 20" in from the edges of the very smooth, flat piece of plywood.

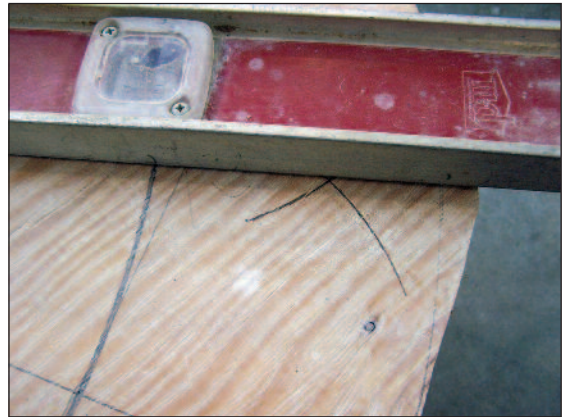

photo: Michael Wendt

STEP 5 Set the nail at one of the cross points and swing it left and right to obtain two more cross points.

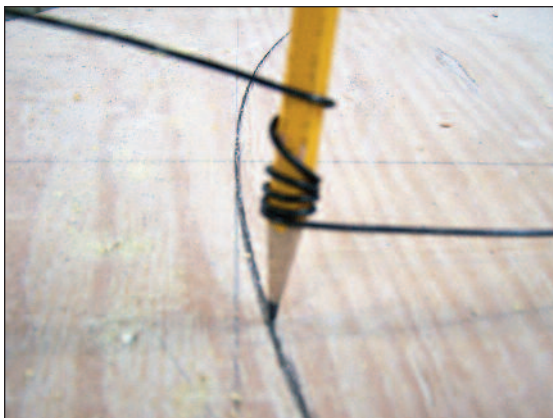

photo: Michael Wendt

STEP 3 Adjust the wire until the pencil scribes a circle 14.25" in radius (28.5" diameter).

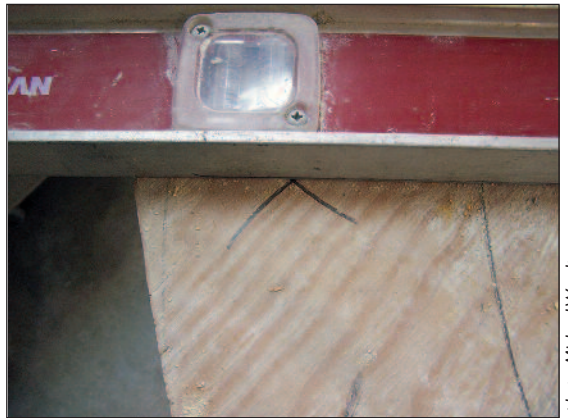

photo: Michael Wendt

STEP 6 On the other side of the circle, repeat step 5, obtaining two more cross points. This divides the circle into 6 sections.

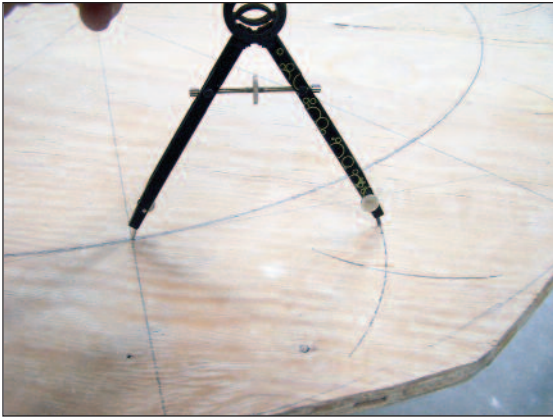

photo: Michael Wendt

STEP 7 Use a standard bow compass to draw 12 new arcs. Where these cross represent the other 6 sides needed.



photo: Michael Wendt

STEP 8 (continued)

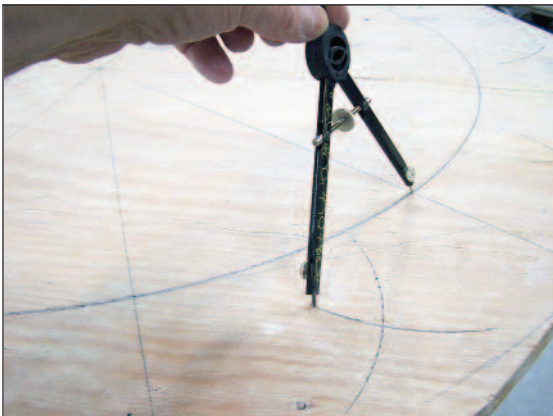

photo: Michael Wendt

STEP 7 (continued)

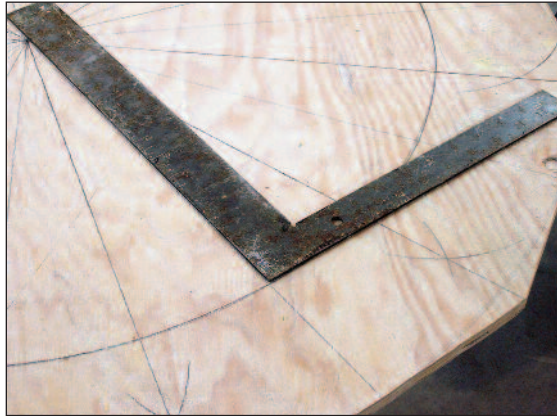

photo: Michael Wendt

STEP 9 Place a framing square on a ray where it crosses the circle and draw a line first left, then right.



photo: Michael Wendt

STEP 8 Draw lines through the center connecting the rest of the cross points and creating 12 equally spaced rays.



photo: Michael Wendt

This shows the inner face of the brick. Repeat for each of the 12 brick faces creating a 12-facet figure. This shows you exactly at what angle and where the bricks need to be cut.



photo: Michael Wendt

STEP 10 Cut the bricks and then lay them on the board so that their inner faces match the inner guide lines.



photo: Michael Wendt

STEP 11 Trace the outside of the bricks and trim the board to match the layup as shown.



photo: Michael Wendt

STEP 12 This pattern board is also used to lay up and construct both the base and the lid to the kiln.

Note: (Note: These are instructions for a 12-brick circle only. You'll need a protractor to draw a 10-brick circle of 36° for each brick.)

The Design

This kiln is made up of 22 layers of G26 IFBs, including lid and base. Each wall layer has 12 bricks.

Each banded ring is 5" tall and made up of 2 layers of brick. Since the bricks weigh about 3 lbs each, each ring weighs about 75lbs, which makes for easy lifting by two people.

The total loading space of the kiln is approximately 40" with the split between top and bottom coming right in the middle at 20".

The Lower Half

The lower half of the kiln is made up of 12 layers of brick. The bricks in the walls do not need to be mortared—banding them is sufficient, though there's no reason they couldn't be mortared. When you build your own kiln you may have as many layers as you wish. This is a very flexible plan.

The Kiln Base

The bottom layer or base is solid brick and should be mortared.

The Upper Half

The upper half is also made up of banded rings. The hoist attachment ring is at the separation split.

I selected the height of the split to match the most convenient loading height and to also reflect the amount of head space there was in the kiln room.

The Lid

The lid is solid brick, just like the base. And, again, these bricks **do** need to be tightly mortared and banded to prevent sagging.

Traditional top-hat kilns like Hank Murrow's Doorless Fiber Kiln lift the entire kiln. This requires a lot higher ceiling than my design, which fits a room with a 8' ceiling.

Also, the lower section acts as a convenient guide to shelf placement during loading.

Cutting the Bricks

I use a 10" miter saw with a carbide-tipped blade, goggles, and a dust mask. Before you cut any brick, get some cheap wood like pine boards and practice the layout. Check the exact angles and fit the pieces of wood up until you have the angles set correctly, since the scale on the miter saw is only close, not exact.

I also constructed a stop block system made of a strip of metal so that I could make every brick identical. Cut all the bricks you need for all the rings plus a few extra to cover damage or breakage so that you don't need to go through the whole setup procedure again later.

Cutting the Pattern Board

Stack one course of the bricks accurately onto the board; then, trace carefully around the outside. Remove the bricks and cut the outside shape of the kiln board.

Next, I place the bricks back on the board with the rest of the bricks and use a coarse 36-grit sanding block to finish truing and fitting the trimmed bricks.

Mortaring the Bricks for the Lid and Base

Both the lid and the base require both a clamping band and the use of Sairset® or some other kind of high-temperature mortar.

Make sure you cover the pattern board with a plastic sheet before laying up the bricks you are going to mortar.

Banding the Rings

Banding the rings is simple too! Go to a heating and air conditioning company and check to see if they have any strips of light-gauge stainless steel sheet metal 4–4½" wide and 10' long.

The bricks are mitered and laid up on the pattern board. I dampen the bricks before assembly to allow easier movement for best alignment. Then the metal ring is installed and tightened to sufficient tension to allow the ring to be lifted into place on the kiln hearth.

Carefully wrap the band around the brick layer you want to band and mark the overlap if any. Remove the band and pop rivet two or more stainless steel radiator clamps which have been cut in half to the ends of the band, making it possible to loosen and tighten the band as needed. Once assembled, tighten the clamping band and let dry before moving.

Cutting Holes for Burner Ports

First, I accurately located the burners, then cut the burner ports to fit. I cut the holes for the burner ports with a large drill bit followed by a threaded rod. This was used to rasp the hole to the preliminary size. I enlarge them gradually over several firings until the kiln fires evenly. If you are designing your own movable top kiln, make sure you position your burners before you cut the ports.

The Lift Ring

Here are two views of the lift ring. This earlier version used only lift tabs. Later versions use a full perimeter lift ring because after a while the bricks break from the lifting forces caused by the small tabs.



photo: Michael Wendt

How the Bricks Are Grooved

I use a drill press rather than a router because it generates much less dust. The groove only needs to be slightly deeper than the thickness of the metal lift band.



photo: Michael Wendt



photo: Michael Wendt

Notice the "U" straps act to guide the kiln along the pipe but still allow easy movement.

Cutting the Hole for the Exhaust

This kiln has no chimney, as such, but it does have a hole in the lid to create exhaust. The top hole is cut using a 6" hole saw I made from a coffee can. I cut slits in the open end and bent them inward and outward alternately. In the end, I fastened a 1/2" bolt which allowed me to turn it with a 1/2" drill and cut the flue hole in the lid. You must have adequate airflow and venting for this system.

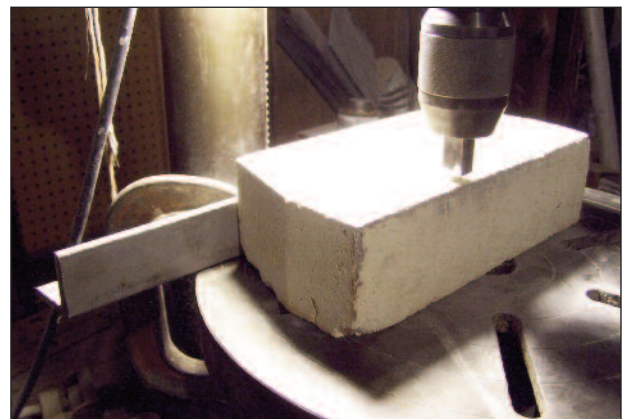

photo: Michael Wendt

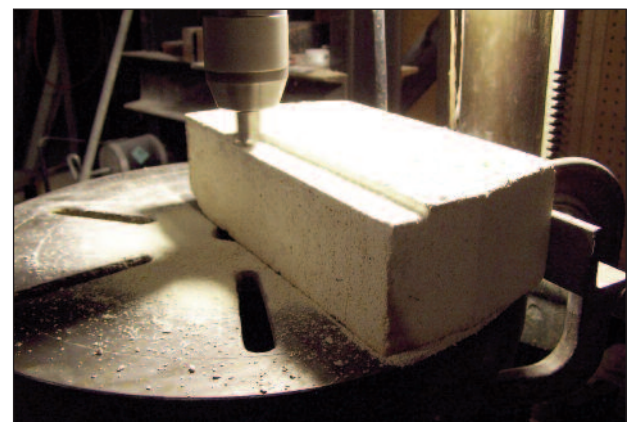

photo: Michael Wendt

(This groove will allow for the metal lifting surface to run around the entire perimeter of the kiln. It's an improvement on the lift tab design.)

Making the Handles

I also recommend the installation of at least two lifting handles per ring and it works best to keep the weight of the rings down to an amount you and another person can easily lift.

Making the Lift Ring

As you work on the hoist attachment (or lift-section) ring, first install a $\frac{3}{4}$ " carbide router bit in the drill press and clamp a piece of angle iron to the drill press table in a location that will allow you to route a $\frac{1}{4}$ " deep groove along the entire perimeter of the outside edge of each brick in the lift ring. This is where the lift tabs welded to the lift ring will fit.

The lift assembly consists of two sections of 4" x $\frac{1}{4}$ " steel or stainless steel flat bar formed to exactly fit the outside of half the layup pattern board. A bolting tab with provision for two $\frac{3}{8}$ " grade-5 bolts is welded to each end of the assembly so that when bolted they make a single ring that is an accurate fit to the bricks and is in as true a plane as possible so that the bricks do not break when lifted.

Making the Lift Cable Guide Pipes

A pair of large "ears" are welded to the ring 180 degrees apart. These ears have U-shaped flat bar guides bolted to them and a provision for attaching the steel cables. The U-guides need to be sized correctly to allow them to slide up and down the 2" steel support pipes that carry the cables and pulleys needed to connect the kiln to the concrete counterweight system.

The three T-shaped pipe frames consist of 2" ID (schedule 40 thickness) steel pipe sized for the head space you select. One is used as a guide for the counterweight and the other two

The Hoist

Below are the hoist details. A 1" shaft is used in conjunction with pillow blocks to synchronize the counter weight with the two kiln hoist cables.



photo: Michael Wendt



photo: Michael Wendt



photo: Michael Wendt

The Counterweight

The final view shows the counterweight which is made from concrete blocks I cast in a homemade mold. I weighed every part of the upper kiln half, added the weights and mixed up the same weight of concrete.

Notice that there is a piece of rebar with a flatbar tab with a screw hole bedded into the wet concrete to allow the counterweight to be fastened to the kiln counterweight hoist component.



photo: Michael Wendt

act as guides for the kiln itself. Short pipe sections large enough to slip the 2" pipe OD are welded to the ends of the counterweight T as well as the kiln guide Ts and have $\frac{3}{8}$ " nuts welded to them in such a way that $\frac{3}{8}$ " bolts can be used to clamp the kiln guide Ts and the cross pipe at the other end of the kiln guide Ts firmly in alignment.

Obviously, all the pipes must be dead vertical and parallel to each other in order for the lift system to work properly. Buy four 4" diameter cast iron pulleys—two bored to $\frac{5}{8}$ " ID and two bored to 1" ID. Purchase two bronze bushings $\frac{5}{8}$ " OD x $\frac{1}{2}$ " ID x $1\frac{1}{2}$ " long and press them into the $\frac{5}{8}$ "-bore pulleys.

Once the T-shaped kiln guide pipes are welded, measure 2" from the centerline of the vertical guide towards the wall end of the pipe and

carefully drill a $\frac{1}{2}$ " hole through both sides of the pipe so that $\frac{1}{2}$ "-diameter bolts can be used to act as axles for the pulleys. On the counterweight T, weld flat bar pads wide enough to accommodate two 1" pillow blocks which will support the 1" cross shaft used to synchronize the cable lift system to both sides of the counterweight.

Making the Counterweight

The counterweight consists of a slide portion using the same U-shaped bolt on flat bar slide guides bolted to a frame shaped like a capital "H" on its side. The lower portion of the H is U-shaped to capture the small counterweight segments cast from concrete. I included a piece of rebar with a steel tab which had a mount hole pre-drilled to allow the upper part of the counterweight to be bolted securely to the upper portion of the H-shaped counterweight guide frame. The reason I made the counterweights of concrete (approximately 40 lbs each) was to allow the kiln counterweight to be easily and quickly moved, if need be. Also, the best lifting action comes when the kiln and the counterweights are as close to the same weight as possible.

Carefully clamp the cables to the mounting holes and tension them as close to the same as possible. On my kiln I used a heavy turnbuckle on one of the cables to allow me to equalize the tension and make sure the kiln slid up and down easily.

Install the Burners

Burners and firing configurations for these kilns are critical. Most Olympic styles now employ two burners, but when they were based in Seattle, WA, they used six small burners which

gave very even heat around the entire perimeter. If possible, I recommend this configuration of six 40,000 BTU/hr. burners as opposed to the two-burner design.

Firing Tips

Some people report that their ring kilns fire too hot at the top while others complain the bottom is too hot. To obtain even firings, I believe a dual-probe pyrometer is essential, with one thermocouple 6–10" from the bottom and the other 6–10" from the top. In this way, the rise rate at both locations can be compared.

I found my six-burner kiln ran much hotter at the top than the bottom, so I made some flame spreaders which sat directly below the bottom kiln shelf—set 2½" above the kiln bottom. I could adjust them outward over the burner ports. Using cone packs throughout the kiln, and moving them outward slightly more each load, I finally reached a setting that made the top and the bottom operate within a few degrees of each other.

Make only very small changes each time to avoid overshooting in the other direction, and set the damper very accurately each time to eliminate it as a variable. An Oxyprobe is also a great tool for learning to fire this type of kiln.

I learned to recognize the setting that was most efficient, allowing the fastest rise rate possible, which saves fuel and shortens firing time. We used to say: "In by 10:00, over by 5:00."

Nowadays though, I have deliberately slowed the kiln firing rate by two hours of soak near top temperature and the finished quality of the glazes is much smoother with far fewer seconds due to glaze blisters and other defects in finish.

Summary

Top-hat ring kilns are ideal candidates for schools, art programs or small home or production studios because they offer a unique blend of features that encourage potters to explore the medium. Most notably, they are very easy to build, load and fire. I have used them exclusively for over 35 years and plan to continue.

*Michael Wendt can be reached at:
wendtpottery.com*

A Raku Kiln by Marcia Selsor

I have been building raku kilns since a workshop with Paul Soldner at Wallingford Art Center outside Philadelphia in 1968 in the snow. That construction was a corbeled arch with hard brick. In the past forty years, I have built many more, experimenting with fuels, insulation, and drafts.

Upon retirement I built several more raku kilns. I wanted a large portable kiln with a pulley system. I designed a frame that could be broken down into sections: top, bottom and four posts. The base frame sat under the two layers of brick floor of the kiln. These were constructed of 1" square tubing and slightly smaller dimensions that could slide into the former. The posts were the larger dimension. The expanded metal frame was approximately 36" deep x 27" wide x 32" tall. The base could be raised by adding more layers of brick. This means that pieces taller than 32" could be fired. The chamber could be raised to clear taller pieces.

When I moved to Texas, I left my raku kilns in Montana with my former co-op partners. I built a concrete kiln shed 12' x 19', a dimension that squeezed between a very fine ruby red grapefruit tree and the patio and carport (soon to be studio). I installed steel barn doors for easy



Marcia Selsor's kiln.

access to the raku kiln. The first kiln was a portable, built with ceramic fiber and sprayed with ITC. After a few uses the fiber starting disintegrating. I built my dream raku kiln next. I wanted it lightweight, on pulleys, and easy to lift so I could fire alone. This raku kiln is built into the shed with pulleys on the ceiling. The frame is made of an expanded metal mesh used for stucco and steel straps screwed through the mesh to hold the shape in place.

*Marcia Selsor can be reached at:
marciaselsor.com*

7

KILN STORIES: ABERNATHY STYLE KILNS

**The Abernathy Kiln:
The Perfect Urban Kiln
by I. B. Remsen**

In the mid-1950s, J.T. Abernathy, a studio potter in Ann Arbor Michigan, developed a radical new design for a potters kiln. It was based on the concept that you should put the burners where you need the heat energy. There are at least a dozen Abernathy kilns in the Ann Arbor area. We will present three: the largest kiln at the Ann Arbor Potters Guild built around 1956, The Remsen studio kiln built in 1971, and the Ann Arbor Art Center's Art Factory kiln built in 1999. They are all very similar in design, a square or 4 x 5 ratio rectangular floor area with a wall as tall as the longest dimension of the floor and a sprung arch. The ware stack is centered on this floor and fills all the space between the back wall and the door, but there is a gap of 6" to 9" between the stack and the two side walls. This gap is continuous from the floor of the kiln to arch.

On each side of the ware stack there are two forced air burners across from each other with

flame running parallel to the stack (four burners in all). These burners are on opposite sides but at different levels. One is at the floor level and the other is just above the midpoint between the floor and the arch. All of these burners are run from one large blower. This blower is a high-speed radial type capable of delivering 800 cubic feet per minute with pressure. The blower air comes into a chamber where it is mixed with



photo: Mel Jacobson

An Abernathy-style kiln

gas, and this mixture is piped to the four burner ports, which are fitted with cast iron nozzles. The kiln also has atmospheric pilots and possibly small atmospheric warm-up burners.

Whether they are updraft or downdraft, conventional kilns rely on a passive convection system as the main mechanism for distributing heat. The Abernathy kiln could be called a push draft/radiation system. It has no chimney. It relies on pressure from the burner system to push heated gasses into the kiln as well as radiation from the walls next to the burners to distribute the heat towards the center of the kiln. The only exit for the heated gasses is a small view port in the bottom of the door (for a 44 cubic foot kiln this opening might be 2½" x 4½"). The kiln is lightly pressurized at all times while the main burners are on.

The beauty of this design is that it opens up two opportunities. First, the elimination of the chimney, and second, rapid firing for larger kilns. Fred Olsen and Dan Rhodes both estimate that somewhere between 30% and 40% of the heat energy put into a conventional kiln goes right up the chimney. Without a chimney, more of the energy put into a kiln goes towards heating the ware. And not having a chimney allows for more flexibility in kiln location.

Heat loss is an increasing factor over time while the kiln is firing. The longer it takes to fire a kiln, the more heat is lost, and the less efficient the firing. However, fast firing of conventional kilns usually results in uneven temperatures. The passive system of heat distribution leaves

cool spots that will not “catch up” without prolonged “soaking.” Once the main burners are on the Abernathy kiln fires very evenly throughout and can be fired very quickly.

All of the Abernathy kilns in this survey were constructed with 9" of insulating brick. They were all fired with natural gas, which is figured to have 1000 BTU/cu.ft. The method of firing is to pilot overnight and bring the kiln to roughly 800°F before turning on the main burners.

First we will look at two kilns that are fired to cone 10: the large Potters Guild kiln and the Remsen kiln. For our baseline comparison we will use data from Ward Burner Systems' Data Guide (*wardburner.com*).

Ward estimates that at 16,000 BTU/cu.ft./hr. a kiln with 9" of insulating firebrick would fire to cone 10 in about 6–7 hours. This would mean a total consumption of between 96,000 and 112,000 BTU per cubic foot. We can assume that a slower firing would result in higher overall consumption. So this rate of consumption is the most efficient for a conventional kiln.

Fuel Use Estimates for Conventional Kilns

Construction: 9" Insulating Brick		
Cone 06	Cone 6	Cone 10
6,000–10,000 BTU/cu. ft./hr.	8,000–13,000 BTU/cu. ft./hr.	10,000–16,000 BTU/cu. ft./hr.
<i>from Ward Burner Systems</i>		

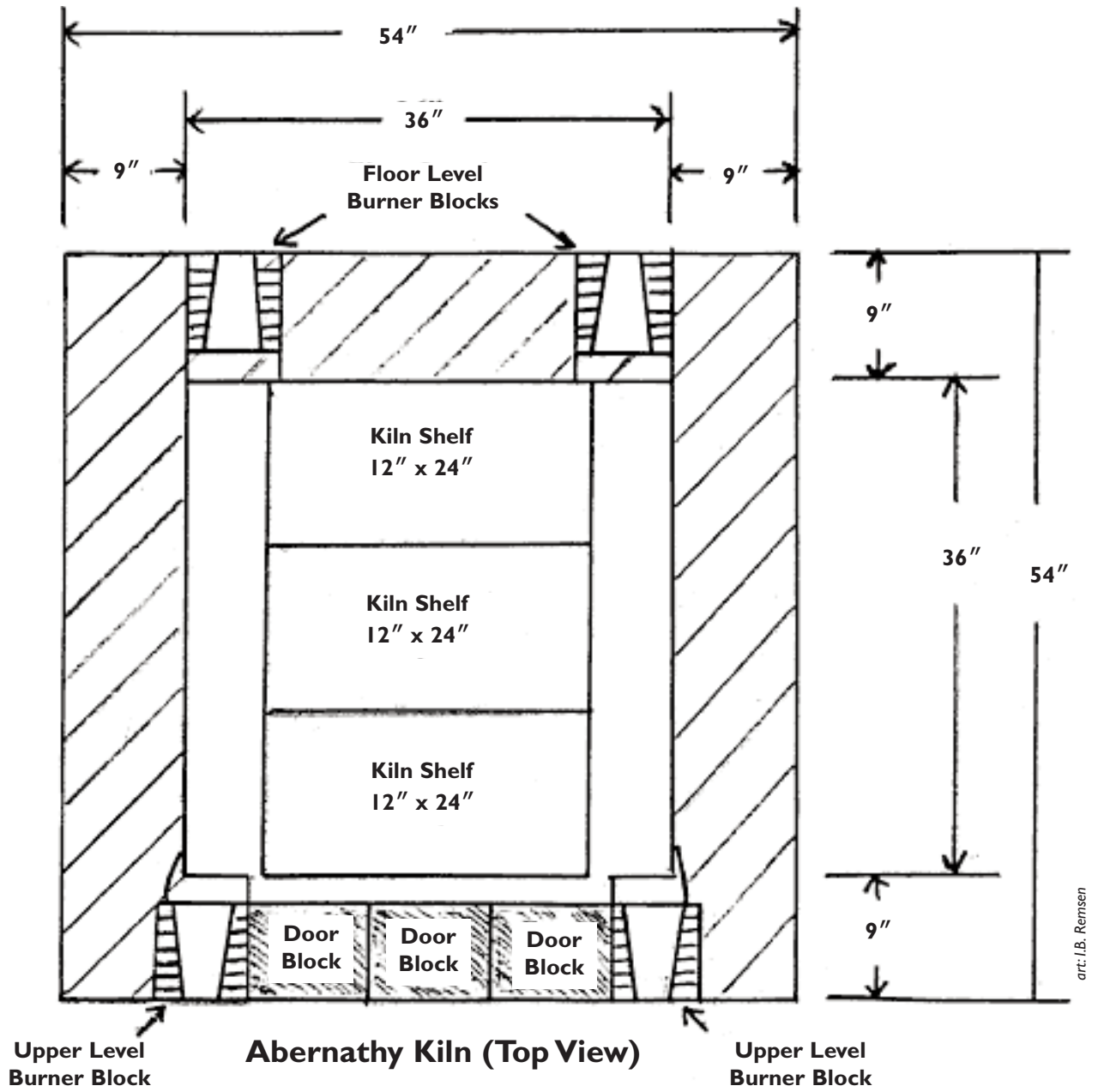

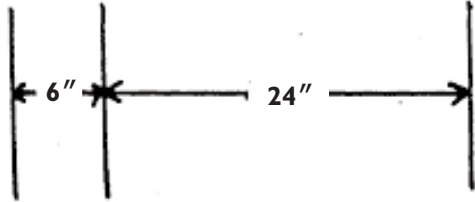
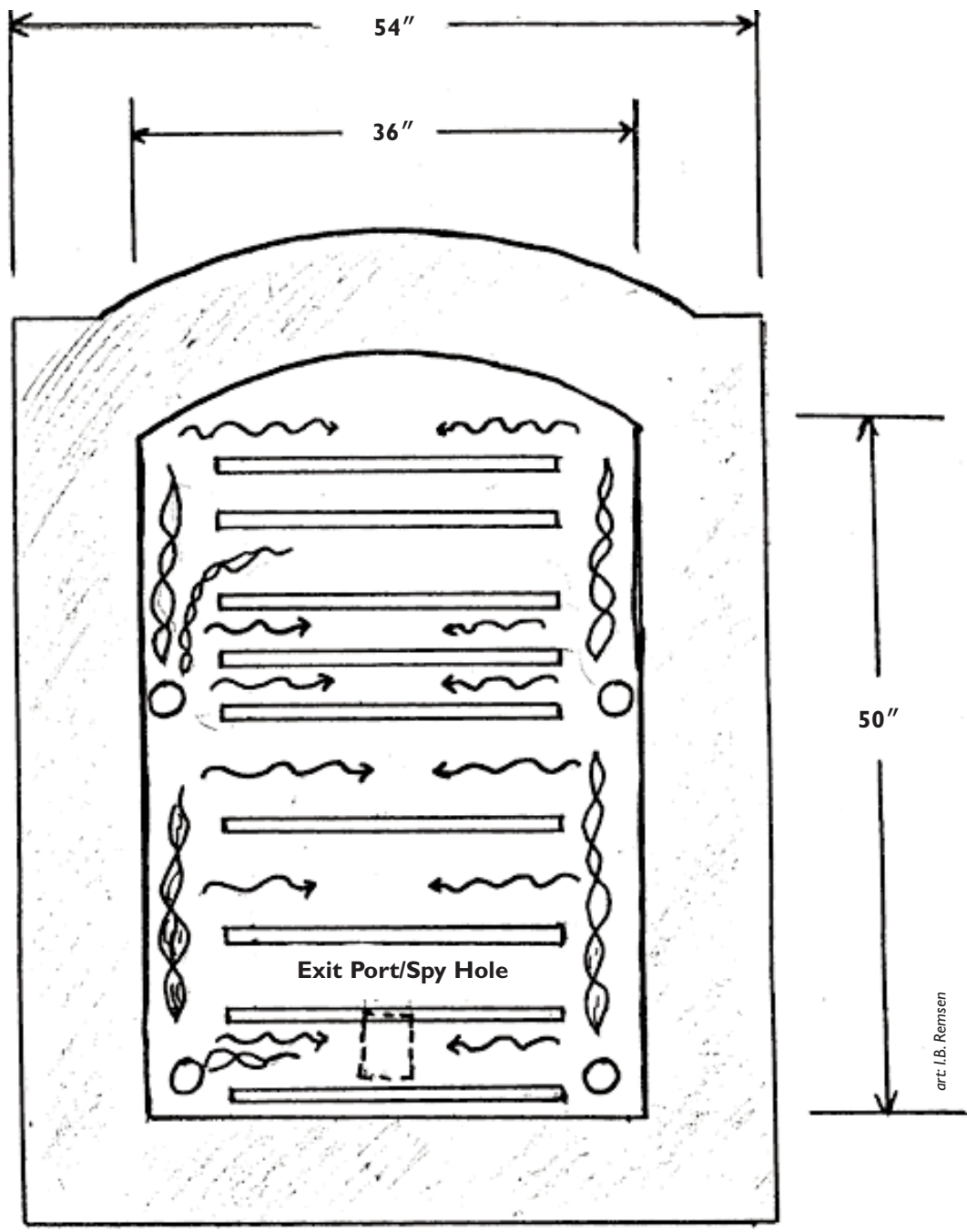

**Front View
(Interior Layout)**

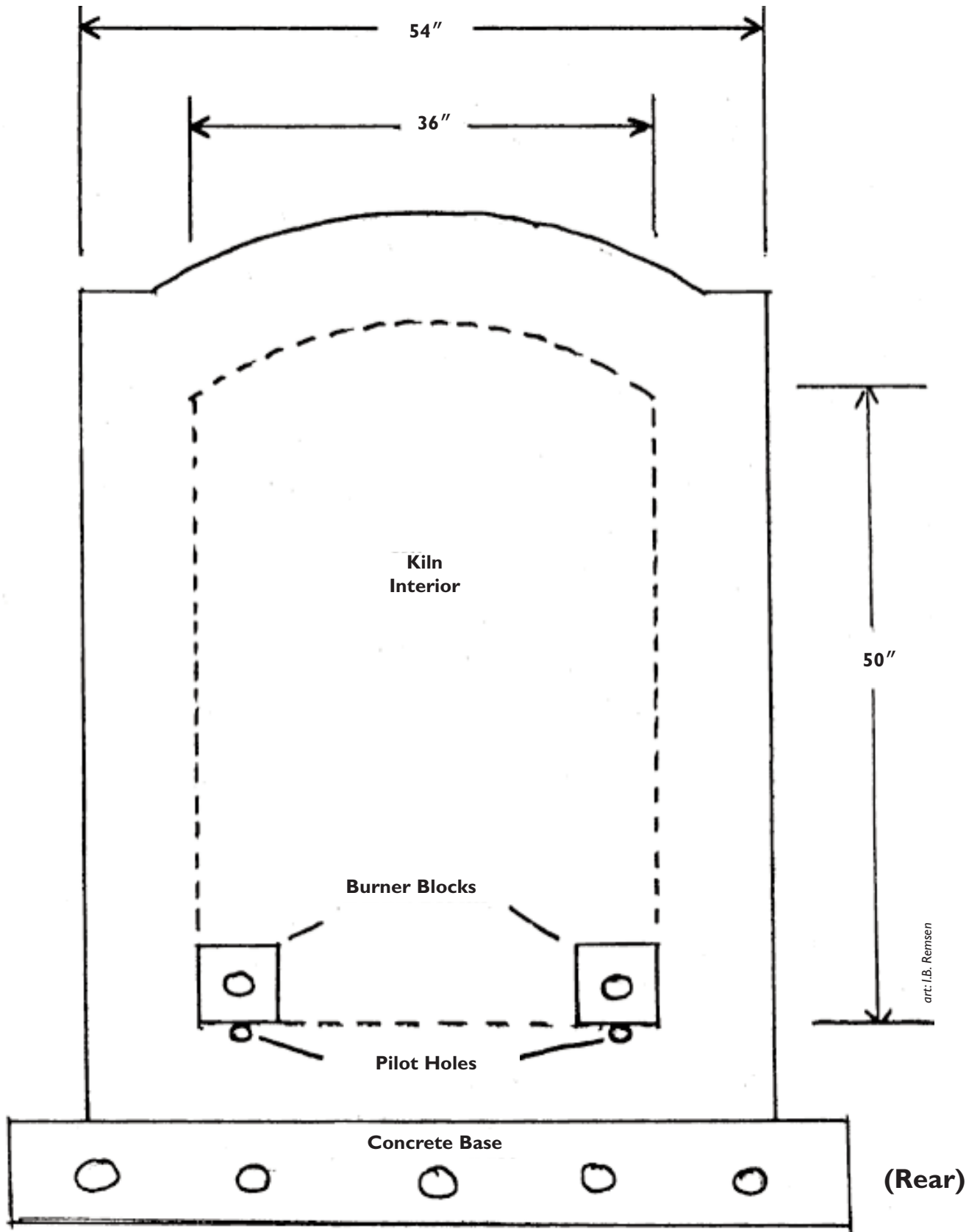

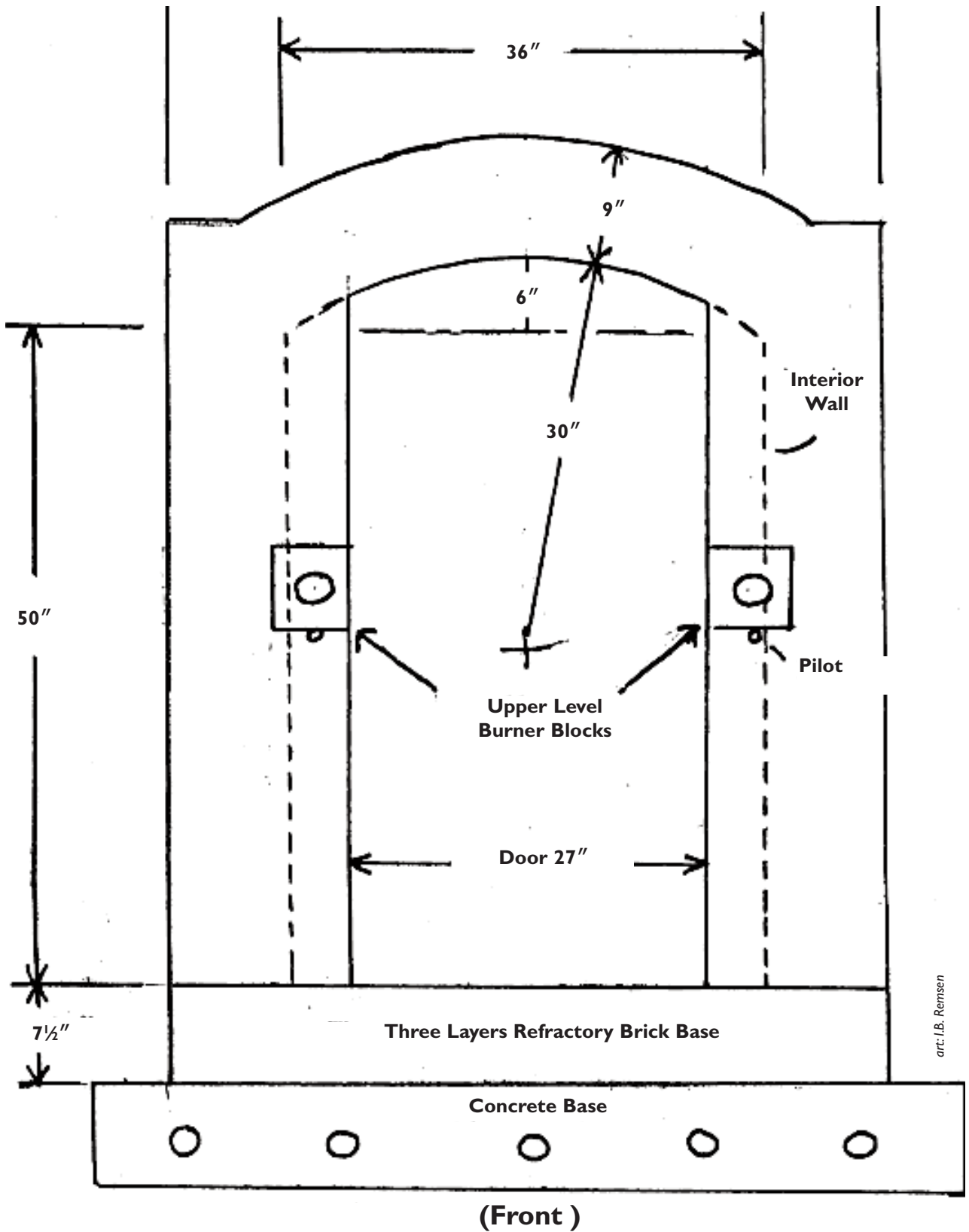

art: I.B. Remsen

Large Potters Guild Kiln

Size: Floor 66" x 48"

Height to 2/3 of sprung arch = 53"

Total 167,904 square inches or 97 square feet

This kiln was built around 1955. It is located in a large cinder block room with two large exhaust fans. Repeated firings of this kiln show that it consumes 8,400 cubic feet of natural gas in a cone 10 firing, which normally takes 12 hours. These firings involve body reduction as well as glaze reduction producing the traditional copper reds, iron greens and yellows. This is roughly 8,400,000 BTUs, or 700,000 BTUs per hour. Ward's table indicates that a conventional kiln of this size would consume between 9,312,000 and 10,864,000 BTUs if it could be fired in a more efficient time of only 6–7 hours.

So the Potters Guild kiln seems to be firing 10 to 20% more efficiently than an optimum firing of a conventional kiln. But the real efficiency of this kiln can be seen when you look at the BTU per cubic foot per hour consumption. Dividing 700,000 BTUs per hour by 97 cubic feet results in 7,216 BTU/cu.ft./hr. Looking at the table on page 120 we see that this is 30% less than the suggested minimum figure for a cone-10 firing in a conventional kiln. This seems to indicate that faster firing might produce greater efficiencies.

Remsen Kiln

Size: Floor 36" x 36"

Height to 2/3 of sprung arch= 56"

Total 72,576 square inches or 42 square feet

This kiln was built in 1970. It is located in a small wooden garage near the front door. Over the door there is a large exhaust fan operating at 2,500 cubic feet per minute.

Repeated firings of this kiln show that it consumes 2,800 cubic feet of natural gas in a cone 10 firing, or 2,800,000 BTU, which normally takes 6 hours. This is a reduction firing from cone 01 up.

A conventional kiln would require 16,000 BTU/cu.ft./hr to fire in this time and would need 672,000 BTUs per hour or 4,368,000 total BTUs to complete the firing. The Remsen kiln uses 430,769 BTUs per hour to achieve the same effect, at a savings of roughly 30%.

Looking at this in another way, we can refer back to the chart and see that this kiln fires as quickly as a conventional kiln of the same volume but with only two thirds of the gas normally required for a fast firing (10,256 verses 16,000 BTU/cu.ft./hr).

Art Factory Kiln

This kiln is the newest of the Abernathy kilns in Ann Arbor. It was built as a workshop project in 1999 for a total cost of around \$6,000, including the furniture. It is an exact copy of the Remsen kiln with some minor modifications. It has been fired six times to cone 6 using about 2,500 cu ft of gas in about 6 hours. All firings used heavy reduction. Data from this kiln is difficult to evaluate for a number of reasons.

First, the kiln is located outside in an exposed location and has only been fired in the winter months. Second, this kiln has a solid cast block door, not an insulating one. Still, it is in the low range of 9,469 BTU/cu.ft./hr. (compared to Ward's 8,000–13,000 estimates). Ward's estimate for total consumption of a 42 cu. ft. conventional kiln fired to cone 6 in six hours is 3,276,000 BTUs. Comparing this to the figures for the Art Factory kiln shows only a 24% reduction in gas consumption. Improvements in the door's insulation, warmer weather use, and perhaps a wind baffle should improve its efficiency.

Conclusions:

Although the Abernathy design is roughly 50 years old, it is perfectly adaptable to the needs of today's ceramic studio. This design and burner system, combined with fiber insulation, would result in further significant fuel economy. The elimination of the chimney creates a situation where one has absolute control over

the air and fuel input. Combined with today's digital technology, this control would allow for infinite flexibility and improved efficiency in firing. This burner system could be retrofitted to any sprung-arch kiln, and would probably improve its efficiency and dependability.

I.B. Remsen can be found at ibremsen-potter.com

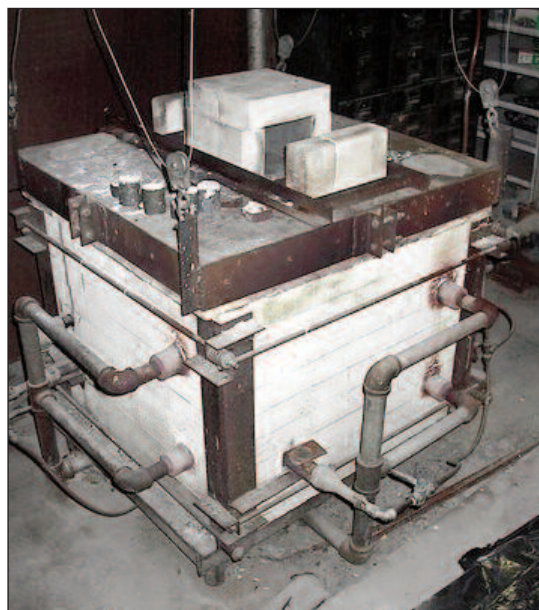

photo: Mel Jacobson

Here's an Abernathy style kiln with a movable top.

J.T. Abernathy Style Kiln by Kathi LeSueur

J.T.'s design is based on a cube. The size is determined by the shelves you use. The brick is stacked as you would any kiln except that you leave openings for burners at the front bottom on either side, and mid-high back on either side.

When the door is bricked up, the center brick in the first three rows is left out. This acts as a flue. Peepholes are put in mid-high and a few rows from the top.

J. T.'s Burner System

J.T.'s kiln uses a large central blower at the back. (What size you ask? Whatever he could find at a junk yard.) The blower is attached to a "mixer," a 4" tube of black pipe. The tube has a hole drilled in the side and a street ell (a threaded pipe with a 45° or 90° bend) is welded in place to form a gas jet. A brass cap can be drilled to the proper orifice size and screwed onto the street ell. From this mixer pipe the gas is sent to both the front and back burners, which are just pipe with a commercial Sticktite nozzle attached. It's been a long time since I saw these so I'm not sure anymore how J.T. lit them or what safety he had on them.

Kathi's Kiln Design

My kiln's just one of many variations on J.T.'s design. It has two stacks of shelves front to back, 24" x 14". It has a sprung arched top. There is 7" of space between the shelves and the interior walls of the kiln—actually a little less front and back on mine.

The Door Creates the Flue

A flue is created when you brick up the door. On my kiln the door is seven bricks wide on the end side. So, for the first three rows, the #4



photo: Kathi LeSueur

Kathi LeSueur's Abernathy-style kiln.

(center brick) is left out. There is a peephole mid-high and one several bricks from the top.

The Burners

I opted for four forced air burners rather than one central burner. Two burners are on the front at floor level on either side. The opening going into the kiln is right at the interior wall.

Burners on the back are placed mid-high on either side. I built the burners myself from black pipe threaded at both ends, an Eclipse Sticktite nozzle (1½"), and a Dayton squirrel cage blower.

Gas is supplied to the blower by drilling a hole thru the black pipe and welding a street ell pipe fitting in place. A brass cap drilled to the proper orifice size is then screwed onto the street ell inside the burner. A floor flange is attached to the other end of the pipe and the squirrel cage blower is screwed onto that.

My blowers have a piece of metal that can be opened or closed to control the airflow into the

blower. I control the flow of gas with a gas cock on the main gas supply pipe, but I have gas cocks at each burner so that I can have just one or two on at a time. Adjustments can be made during the firing if the kiln is uneven.

Opening the top peephole will draw heat to the top. Sliding in a brick at the bottom will help there if it's a little cooler.

Firing Notes

J.T. fired his kiln in oxidation. I fire reduction. It works well with either. I can control reduction both by increasing or decreasing gas at the main gas cock and by how much I open or close the flap on the blower.

I have marks on the blower for where to set the flap. I installed the gas cock so that the handle was parallel with the wall behind it. Then I took a protractor and marked off degrees. I have a wire that extends from the handle that can line up with the marks on the wall. So, in my records I have:

Gas – position 4

Air – position 9

It makes it easy to adjust if a firing is over or under a little.

Safety Precautions

My father was a salesman for an electronics company and had them make up a solenoid valve relay system so that if the power goes out, both the gas and electric shut down until I reset the “on” button. This has come in handy many times.

My studio is post and beam so the ceiling is high. I had an 8' hood made by a retired heating and cooling sheet metal guy and it's

hooked up to a large blower. There are also two wind turbines in the ceiling to help take heat out of the room.

Ventilation is a must. I have two garage doors that I open about a foot each when firing. I was told by the guy who made my hood that more open than that would cut down on the draft, and the hood would be less effective. The studio is lined with fire resistant drywall, and I'm going to get some fire resistant paint to coat any exposed wood.

A Bit of History

This kiln was originally built in south Texas in 1982. In 1987 I tore it down, boxed up the brick and shipped it to Ann Arbor, Michigan. I rebuilt it on a temporary foundation and the following year tore it down again so I could put it on a cement slab. In 1990 I added on to my studio so that I could move it inside. Once again it was torn down and rebuilt.

So, this kiln has been inside for nineteen years without a problem. It looks a little rough, but still fires like a charm. But, I must say I'm jealous every time someone puts up a shot of a brand new kiln with that beautiful new brick. This design could be used with a flat-top, a car kiln, or like mine, a door that rolls up.

*Kathi LeSueur can be found at:
lesueurclaywork.com*

8

KILN STORIES: CAR KILNS

A car kiln is the easiest loading kiln there is. The kiln floor runs on a track that is pulled from the kiln and sits any place the track will take it. Most floors just pull straight back a few feet from the main kiln.

The potter can work around the car, loading it with ease. There's no bending or leaning into the kiln. Shelf placement is easier too.

The major drawback is the space required for the moving car and track. That more than doubles the footprint of the kiln. The floor must be very flat and smooth around the kiln for the tracks to secure to. A bumpy ride means pots will shake off and shelves will collapse.

Some potters will run the track from the outside, through a door, and into the climate controlled space of the studio. That leaves the kiln, smoke and fumes outside the studio.

Car kilns are very handy and, in some cases, a must for production potters. But that convenience comes with increased construction costs for welding and precision building. Plan and budget carefully before building this kiln.

A Production Kiln by Tom Wirt and Betsy Price

Our kiln is a pretty standard flat-top built to Nils Lou's specs and book *The Art of Firing*. Because we had top room, we added 3 layers of bricks to gain a few extra inches of space. That's one of the beauties of this design—flexibility. When we started building it, I had fired a gas kiln exactly once.

We decided flat-top since, at the time, there were an estimated 1200 in use, and I had no experience in building an arch. To those that say you need an arch, I can attest that the arch is purely decorative. We use the car kiln arrangement, with the track going inside our main building and crossing out to a kiln shed separated by 4 feet. This allows Betsy to load inside in heated comfort (anything for her) yet we don't have to have venting during firings.

Built in 1997–8, this kiln now has well over 750 firings on it. When we're doing shows and under sales pressure, Betsy can turn it every three days with 80 to 100 pieces in each load.

The Stack

For the stack, we have 3 sections of rolled steel plate ($\frac{1}{4}$ ") with fiber liners, each section being about 4' long, for a total 12' of stack. At first we couldn't get to temp—we fired it three times, stalling at 2100°F. Rereading Nils' book *The Art of Firing* I figured that our stack happened to top out at one of the "nodes" he hypothesizes on. We added another section and away we went.

We get about a 1½-cone difference top back to bottom front by the burners. We do two different firings; a very light reduction (.03 Oxyprobe) and a fairly heavy reduction (.77), depending on the glazes being used. Blues, greens, tans, black are done in the light reduction and blacks, reds, iron red, yellow and green are done in the high reduction firing.

Fire in the Roof

In 2003 we had a fire caused by ignition of the roof sheathing around the stack. While we thought we had clearance, we learned that over time the ignition point of wood drops to about 165°F. The fire started about two hours after the firing was finished and both of us had left for meetings. The kiln shed was destroyed, and at one point the firemen blasted the top of the kiln with the hose. Fortunately the assistant chief knew what it was and got the water off it. I suspect that if the water had actually broken through, it might have exploded. Because of this, we rebuilt the top couple of rows and the roof using Nils' new design with a different brick pattern and 3" brick. The new design is considerably more stable.

Also, where the original roof had been built to a torque spec, the new one is done to shape and



photo: Tom Wirt and Betsy Price

Tom Wirt and Betsy Price's car kiln.

feel per Nils' current instructions. The old spec had the tie rods way too tight, causing some spalling in the edge bricks.

Another change I'd make in the plans is to put 2½" x 9" x 18" hard brick around the peeps and burner ports. You have to be careful not to touch them during firing, but they dramatically increase the life of these high-wear areas.

The Lower Front Wall

The other area of concern is the lower front wall where the brunt of the flame hits. We used 2600° brick at the front and side along the flame trench, but over time this wall started to disintegrate. At the suggestion of Smith-Sharpe Firebrick Supply in St. Paul, we repaired this area with a heat-set cement called Corpatch 80. It is designed for repair of continuous kilns. They shut them off long enough for a person in

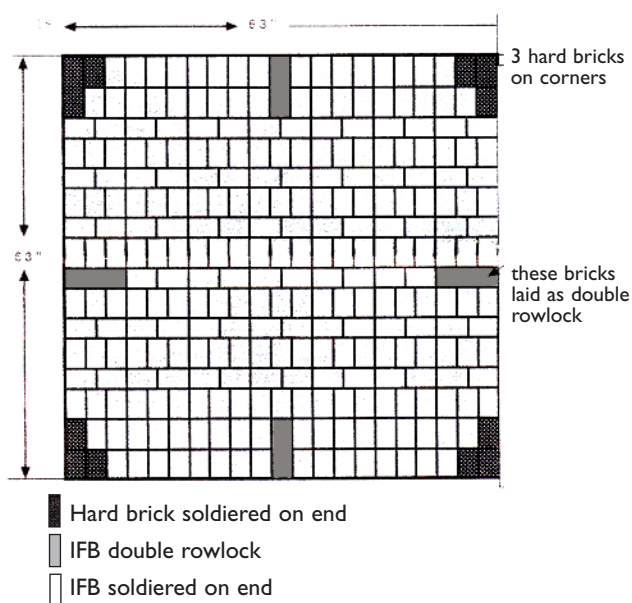

Nils Lou's new roof plan. The roof design consists of 282 IFB straights 3" x 4½" x 9" and 12 hard brick straights 2½" x 4½" x 9". Note that the medium grey bricks in the middle of sides, front and back are set in a double rowlock in order to tie in the outside rows. This configuration prevents the outside rows from bowing out when compressed by tightening the roof tie rods. (Drawing courtesy of Nils Lou.)

a heat retardant suit to go in, do patches and get out, with the kiln never cooling. This material has worked beautifully for sticking in some new bricks and for being built up to form pieces of bricks that have cracked out. When we rebuild this kiln, I would plan to coat the high flame area with this stuff from the start.

Firing on Cold Days

Since we're in Minnesota, and on propane, we have problems keeping gas pressure on days when the temp goes below about 15°F. For years I used a weed torch under (not on) the 1000-gallon tank to struggle through. Turns out it's an extremely hazardous practice and, over time, could cause the tank to rupture. The picture of a 1000-gallon propane bottle rocket caused us to look elsewhere.

We finally heard about a vaporizer unit that takes the liquid propane off the tank and vaporizes it before sending it to the burners. Traditionally these had been used by farmers for their corn dryers and used gas to heat the liquid propane. Relatively recently an electric-fired version has become available. It's safer, and you can install it right on the building. It senses when the pressure drops from the tank and cuts in to maintain the necessary pressure. It's not cheap (\$2500 for the vaporizer and \$1500 to install) but it pays for itself in a few loads under holiday production needs. It also eliminates the possibility of not having enough pressure to get full reduction. This is definitely not the solution for the casual potter, but it works for us.

The Burners

The burners are Ward Mark 500s with full safety (power-out solenoids) as well as thermocouples. Thermocouples don't shut down fast enough on a kiln near temperature. I learned this during a storm one night when I checked the kiln and found two columns of flame shooting up from the burner tips to the ceiling outside the kiln. The blowers had shut down, but the thermocouples were holding the BASO valves open.

We added a couple of Nils' small burners for igniters and reworked the positioning of the thermocouple and upgraded them to industrial standards. We also replaced the pressure gauges with some rated for the level of temp you get at the back of a full-heat kiln. We use pressure on the downstream side of the valve to set our flame.

Safety for Ward Burners

We are using Ward Burners (2 x 500,000 BTU). Marc built in a shut-down feature after I discovered that, in case of a power outage (not that unusual in rural Minnesota), the burners would keep going, as heat coming from the ports would tell the thermocouple that there was still flame in the burner. With the fans off, this resulted in a kind of roman candle effect up the back of the kiln. Marc built in a normally closed solenoid in the gas feed downstream of the BASO valve. It's the "can" between the red button (BASO) and the gauge. This solenoid will shut down the main gas to the burner while leaving the pilot going. If power restores before the thermocouple shuts down the BASO, the fans will restart and the burners will relight. There are systems that use flame rectification for shut down, similar to the circuit that controls



photo: Tom Wirt and Betsy Price

The Ward burner system.

the spark for the pilot, but these are quite expensive. Marc's solution gave us reasonable safety (it has been inspected by a fire marshal) at reasonable cost.

Tom Wirt and Betsy Price can be found at: claycoyote.com

A Flat-Top Car Kiln by Ellen Currans

Mine is a really simple, Minnesota flat-top car kiln, with a fiber-lined metal sewer pipe for a chimney. We reused some of the old brick from the original kiln built in 1979, and added some new 23s we had bought cheaply about 10 years ago. Now we realize why they were cheap. Not very good brick, and you can see that they have changed color and are not holding up as well as they should. We switched from the original weed burners after about 25 firings in the old kiln, and have used the same forced-air homemade burners for both kilns since. Both Nils Lou and Tom Coleman were helpful when we built the first kiln.

We have tried several different ways of stacking and tying the front edge into the walls, even using metal mesh in one case. We still get too much shrinkage over time on the front edge and have had to rebuild that part with new brick several times over the years.

We lay the track each time we move the kiln in and out of the shed. We don't leave the track down between firings. I tend to fire 6 or 7 times in a row, just before a show, and then not fire for several months, so the track lying on the floor would be in the way, and we didn't want to put a groove in the floor. My husband, Sam, has welded a small connector on the two front tracks that slips into the permanent tracks under the cart. He also has made a pipe "puller" to get a good grip on the cart to pull it in and out. I can't open or close the kiln by myself. It is too heavy. He worked on an electric pulley for some time so we could open it automatically, or I could do it by myself, but that turned out to be more of a nuisance than it was



photo: Ellen Currans

Ellen Currans' car kiln.

worth. It was hard to get it to work smoothly without jiggling the ware around too much.

When we load or unload the kiln, we pull it into the shop through two sliding barn doors. The smaller one can be opened easily all the time to check when firing, etc, but the other is bolted shut except when needed. I usually fire only one or two glazes in each firing.

The kiln cart sits between a wall which holds kiln posts and the 1" x 12" x 24" mullite shelves I use for the back of the cart, and on the other side, shelves for bisque, and the 14" x 28" Advancers I use in the front of the kiln. The lighter weight shelves are easier to place across the front and hold larger platters. I would buy more Advancers, except my mullite (after 20 years and no kiln wash) are still in good shape. In the last few years I have had to have help placing the top few shelves.

In the video, Sam shows the kiln cart through the open front door of the studio in position to be loaded or unloaded.

A Car Kiln with Venturi Burners by Chris Trabaka

The design is from Nils Lou's *The Art of Firing*. I liked the concept of the kiln except for one element—the power burners.

I wanted a system that did not require any power anything. I remembered several nights of firing my old kiln when all the power in the neighborhood was out. I basically wanted my old kiln super-sized into a car kiln. What to do? Change the burner arrangement of Nils Lou's design.

In lieu of the power burners in Nils Lou's design, I wanted venturi burners with a continuous pilot light. All other aspects of the kiln design would remain the same.

How Many Burners?

There were some things to research. How many burners would I need to deliver the required BTUs, and could I get them to fit my design criteria? Using the Internet, I found Geil Kiln Company burners. They seemed to do what I needed. Based on their rating, I determined that 6 burners per side should be able to deliver 200% of what I needed (based on the calculations of BTU ratings from Nils Lou and other sources).

Steel C-Channel Supports the Walls

In my original kiln the walls were supported by cement blocks. There were two power burners entering from the rear, and a “deflection” or “target” brick moved the flame up.

The rear of the kiln could remain the same (supported by cement blocks). But the sides had to be supported by a frame that would allow positioning of 6 burners through what was the flame trench.

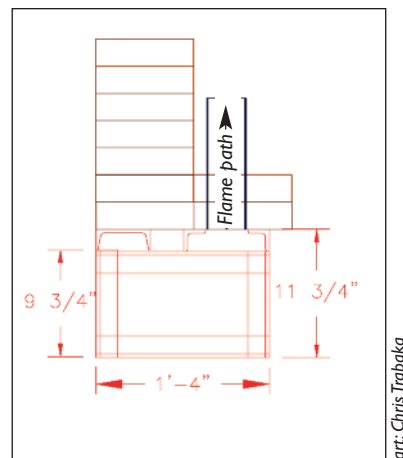

This sketch shows the important components for the wall support and position of the burners from front of the kiln.

The wall sits on steel C-channel and the burners come up between two pieces of angle iron. Note how the positions of the C-channel and the angle iron support the brick for the wall and the flame trench while allowing an opening for the burner.

The framing holding the C-channel and burner openings in place is made up of angle iron.



The burner ports.

The Burner Ports

The opening for the burners is made of soft refractory brick. The sketch shows how the flame will be adjacent to the wall of the kiln—the flame literally hugs the walls of the kiln.

Each burner sits between a pair of brick. The steel was cut to order at a local steel supplier, and the wall supports and the cart were welded together. The kiln was assembled over a three week period. During this time it was necessary to plumb the kiln.

The burner design is based on my prior kiln, a continuous pilot down for each bank of burners and separate valves to control each bank of burners. The most time-consuming part was drilling out the continuous pilot into a single piece of ¼" black iron pipe (gas volume was not necessary).

Masking tape was placed on the pipe and marked for each of the openings for the continuous pilot. At each burner opening a larger hole was drilled so flame was showing above the tip of the burner. The more challenging task was drilling and tapping the openings for each of the 6 burners. Using masking tape, a straight edge, a marker, and a drill press, the 6 holes were drilled then hand tapped. The basic parts were made and assembled.

Firing the Kiln

The first firing was a bisque; this is my only kiln. Using my logs from my previous kiln, I



View from underneath.



A continuous pilot runs alongside.



The continuous pilot lit.



View of pilot from inside kiln.



Lighting the pilot using a mirror.

Photos: Chris Trabaka

didn't have too much trouble (except for the difference between the top and bottom of the kiln). A couple of weeks later, close to Halloween, was the first glaze firing. It was a dark and stormy night (literally); we started the night with rain and ended with six inches of snow. I wasn't sure where to set the gas pressure or the damper, but we managed. I've had the kiln for 10 years now. The kiln has taught me a lot about firing and about learning kilns. I now understand how different each kiln is and how important modern technology (i.e., the Oxyprobe) is. The Oxyprobe has taught me how to set the damper and the gas pressure so that I have a pure oxidation bisque firing and a nice consistent reduction glaze firing. Time and testing has shown me where to set the damper

and gas pressure so that the kiln will stall out just a little after cone 06 drops and just a little after cone 10 drops. I've found that setting the damper/gas to stall a bit after the desired temperature allows the kiln to even out so that the temps on the top and bottom are the same (even in the bisque). Each firing starts with an overnight candle (the kiln is outside and generally damp when I start). By 7:00 am we start adjusting the gas pressure. By 8:00 pm a bisque firing will finish and by 10:00 pm the glaze firing will finish. The following pictures show the state of the burners at various stages of the firing:



Soft candle.



Hard candle.



One inch of water column.



Two inches of water column.



Three inches of water column.

photos: Chris Trabaka

A Downdraft Shuttle Kiln by Halldor Hjalmarson

Halldor's kiln is a 38-cubic-foot downdraft shuttle kiln located under a fire-proof patio cover. The size of the kiln is determined by actual stacking space above the shelves.

Some of the things he considered during this enterprise were: How close to the meter can the kiln be built? Can the kiln be hidden from view? Can the reduction firing flame be made nearly invisible? Can the pipeline be run above ground? Is the kiln location convenient for the studio production process?

Halldor positioned the shuttle kiln between the two studio buildings and built a patio cover over it. The 8' x 10' section of roof directly over the kiln was made entirely from metal, and a sheet metal "sleeve" to hide the reduction flame was

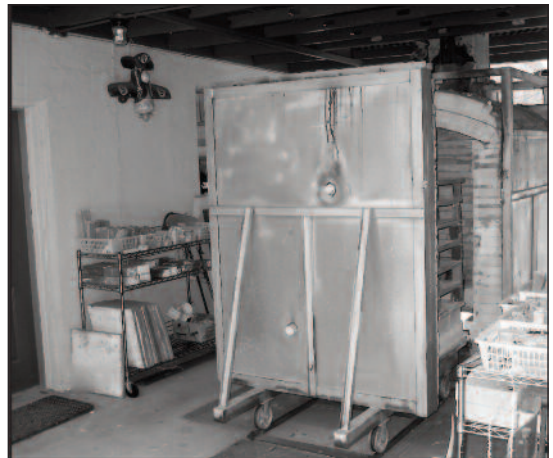

Photo: Halldor Hjalmarson

Halldor Hjalmarson's shuttle kiln.

The kiln is equipped with an Oxyprobe and a digital pyrometer. Both instruments measure temperature and the Oxyprobe indicates atmosphere inside of the kiln (reduction/oxidation). A 2" pipe carries natural gas to the kiln, and easy shutoff valves are installed at the kiln and at the meter.

"Before the gas company came back to install the new meter, Halldor went to a trophy shop and had a brass plaque made which listed kiln specification (including gas requirements) and riveted it to the kiln."

dropped through a hole in the roof, leaving a few inches of air space between it and the top of the chimney. A shade cloth was installed vertically behind the kiln to block the neighbors' view.

Halldor built the kiln of K23 soft insulating bricks on the hot face, and backed it up with 2" of rigid sheet metal and frame. The arch is "sprung" between the rigid metal frame. The door, floor and contents of the kiln roll in and out on 4 metal wheels originally designed for rolling gates.

Connecting the larger 38-cubic-foot kiln to a meter became a problem. After building the kiln in place, he called the gas company and got a representative to come to the pottery. Halldor wanted a new larger meter placed at the connection which served the "outbuilding/studio."

The gas company man kept looking for a label on the kiln that indicated gas requirements, and would not take a verbal calculation based on how much each burner required. In the meantime, he noticed the smaller kiln which was hooked to the house meter, and Halldor

told him that the small meter did not provide enough gas to run the home's furnace and kiln at the same time.

The man said "because the pipeline and small kiln had both been properly installed and inspected (10 years prior) he could install a larger meter to replace the one at the house," and, "because it was fueling a commercial kiln, he could change the usage rate to a lower commercial rate."

Before the gas company came back to install the new meter, Halldor went to a trophy shop and had a brass plaque made which listed kiln specification (including gas requirements) and riveted it to the 38-cubic-foot kiln. After the new large meter (650 CFH) was installed to service the smaller kiln, a new 2" pipeline was laid 18" underground from it to the larger kiln.

*Halldor Hjalmarsen can be found at:
hjalmarsonpottery.com*

Reg Behrends' Flat-Top Car Kiln

My flat-top car kiln is an ideal kiln for the small production pottery that I run in northern Wisconsin.

The greatest asset of the kiln is even firing from top to bottom and front to back. I fire to cone 10 almost every week and have consistent firings every time. The control of reduction is critical in my work, and moving the damper just a quarter of an inch allows me to see slight changes in smoke and atmosphere. Reliability is the key to any kiln, and that is what this kiln excels at.

With 40 square feet of loading space it is a great size for production work, yet I can still experiment with glazes without fear of losing

many pots. And without question, being able to pull the inside of the kiln into my warm studio to load (without leaning into the kiln) is a must for a nearly "senior" potter.

The roof of this kiln has held up beautifully. I can tune the tie rods if the kiln should loosen. Being able to jack up the roof means that I can always have a perfectly aligned kiln.

On one occasion I had to move my kiln to a new building. It was a very simple task to unstack the kiln and totally rebuild. I completed that project in two days.

I fire with propane and often fire in severe cold weather. By adding a regulator to my tank, and having a 3/4" copper feed pipe to the kiln, and then having a regulator on each burner, I can be assured of constant controlled pressure even in freezing temperatures.

My kiln is now ten years old and has fired nearly 700 times. It still looks and works like a new kiln. I am sure it will last my entire life.

*Reg Behrends can be found at:
bluemoonpotteryinc.com*



photo: Reg Behrends

Reg Behrends' car kiln.

9 KILN STORIES: SMALL WOOD-FIRED KILNS

The wood-fired kiln is the most exciting, fascinating and difficult of all kilns to fire. It takes a very dedicated potter to understand the work and organization that precedes the firing.

Dry, split and stacked wood is the key to success. This fuel must be gathered months ahead of the firing day. And you must have a dependable source of wood, year after year.

Many wood-fired kilns fire over days, not hours, and the creation of smoke can be an issue in non-rural areas. Adverse weather conditions can cause stoppage and chaos. Yet, the magic and beauty of the wood-fired process cannot be denied.

A Practical Wood-Fired Kiln for the Studio Potter by David Hendley

I didn't set out to be a wood-kiln firing potter. My goal has always simply been to be a studio potter, and to make a living from my craft. But in 1984, after ten years of making pottery and seven years of firing my own gas-fired kiln, I relocated from the city to my acreage in the piney woods of East Texas. Suddenly I had

more firewood than I could ever use, just from dead trees on the property, and there were several sawmills, generating mountains of scrap wood, within a radius of a few miles. I heated my house, the pottery shop, and even my water with wood. I started a fire almost every day, so it made no sense to install a gas tank and start buying gas just because I wanted to build and fire a kiln.

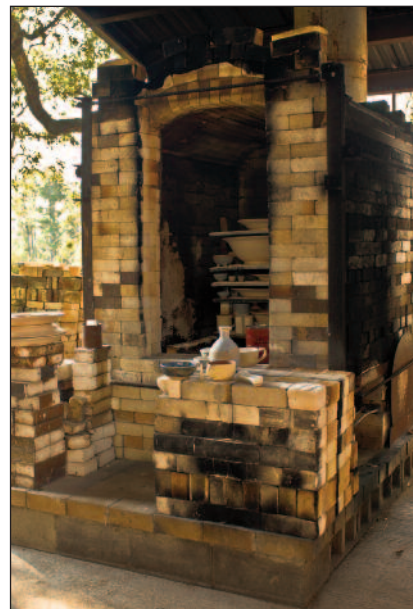

David Hendley's Fastfire-style kiln.

photo: R. P. Washburne

I had built a large two-chambered wood-fired kiln in college in the 1970s, but unlike many wood firers, I didn't have a years-long yearning for my own wood-fired kiln; I liked that wood-fired look, but I also loved glazes, color, and decorating pots. Plus, I worked alone and the typical wood-fired kiln was entirely too large and too hard for a potter to fire single-handedly. Then I remembered the "Olsen Fastfire" kiln. I had once helped build and fire one, and it seemed like it would be a good choice of kiln for a solitary pottery living in a forested area.

I'm now on my second Fastfire-style kiln, and have made several modifications to the original design as specified in *The Kiln Book* by Fred Olsen. Compared to some wood-fired kilns it is speedy, but my firings are nowhere near as quick as the firings Olsen chronicles in his book. I think my kiln could get to cone 10 in about six hours, but, for better results, I aim for about an 8½- to 10-hour firing, which is comparable to a typical gas kiln of the same size.

Advantages of Firing with Wood

When I first started firing my Fastfire kiln I simply used any leftover glazes from my gas kiln in the city, and glazed the pots all over, as I was used to doing. I immediately saw a difference in the glazes; the colors were deeper, the visual textures were richer. It wasn't until several firings later that I started enjoying and looking forward to the fact that the wood firing also enhanced any small, unglazed areas of clay, such as the foot rings of bowls.

With each firing, I started leaving larger areas of the pieces unglazed, to take advantage of the

flashings and ashes from the flames circulating throughout the kiln. Soon, I started developing glazes, slips, and techniques specifically to take advantage of the effects of the wood firing, so now my kiln is an important part of the process and an active collaborator in my work.

How I Modified the Olsen Plan

As detailed in Olsen's book, the Fastfire is an inexpensive, quick-to-build, easy-to-take-down kiln. Mine is larger, and more substantial and permanent. I visited with Fred Olsen several years ago, and he said he has heard from scores of people from all around the world who have built successful variations, from tiny versions to much larger Fastfire kilns.

Since the plans for the Fastfire kiln are in Olsen's book, there's no need for me to include my plans here, so I will simply note the ways I have modified the plans to suit my needs. (You may want to read Olsen's section on Fastfire kilns before investigating my modifications.)

First of all, my kiln has 9" thick walls, and I would recommend that any kiln except a temporary one be built with two courses of brick, tied together every few rows. This is for both thermal efficiency and physical stability. My kiln is constructed entirely of insulating firebricks, mostly G23 (2300° rated) bricks, but with G26s in the areas of the most intense heat, where the flames first enter the kiln. The fireboxes, below the kiln, are built with hard firebricks. Since the fireboxes do not get as hot as the kiln, most any firebricks will do the job.

My kiln accommodates three banks of 12" x 24" shelves, with plenty of space between them, so that makes the outside of the kiln 54" (6 bricks) wide and 63" (7 bricks) deep. The

interior dimensions are 36" x 45". The fireboxes also have 9" thick walls, which means that each firebox ends up being 18" wide. The fireboxes are 6 bricks, or 15" high, and the inside of the kiln is about 52" from the kiln floor to the highest point of the arch, or 45" from the top of the first kiln shelf to the center of the arch. A second, non-structural layer of old, broken 3" thick insulating firebricks is mortared on top of the 4½" thick arch, making a 7½" thick top.

Kiln Foundation

The entire kiln is built on top of a layer of 8"-thick cement blocks topped with 3"-thick hard firebricks, all on top of a concrete slab. I recommend that any Fastfire kiln should be raised off the ground at least this much, for ease of stoking. Believe me, you will have a sore back every time you fire if you build your fireboxes at ground level.

Fireboxes and Flue

Since my kiln is larger than the plans in Olsen's book, the fireboxes, flue channel, exit flue, and chimney are all also larger. Two rows of bricks on the floor of the kiln form the flue channel running through the middle of the kiln. I increased mine from 4½" high to 6" high. Luckily, I was able to find some unusual 6" x 9" firebricks for this purpose. My exit flue is 13½" wide and 9" tall, with a 4½"-wide brick supporting the middle of the lintel. This makes an opening the equivalent of 9" x 9", or 81 square inches. The brick foundation for the chimney has an interior dimension of 13½" x 13½", and a round 15" interior diameter castable refractory chimney sits on top of it. The bottom brick portion of the chimney is about two feet tall and the round castable refractory chimney is about 13 feet tall.



photo: David Hendley

The first four courses of the fireboxes mortared in place. The fourth course is built with 6" X 9" bricks, to create the ledge for holding the fire grates in place.



photo: David Hendley

Looking into a completed firebox.



photo: David Hendley

The chimney floor and completed fireboxes.



photo: David Hendley

The fireboxes covered with tops made of kiln shelves. Each firebox is covered with three 12" x 24" x 3/4" silicon carbide kiln shelves, which also serve as the floor of the kiln. Pieces of broken kiln shelves fill the gap between the two fireboxes. The inside bricks of the first course are notched to fit over the kiln shelves. Note the 24" piece of angle iron over the firebox opening.



photo: David Hendley

The first four courses of the kiln, dry stacked, in place. The fourth course is a stretcher course. G 23 insulating fire-bricks are used throughout the kiln, except in the area where the fire enters the kiln, where G 26 bricks are used. A 13 1/2" X 9" hard brick spans the flue opening.

The Fire Grates

The fire grates in my kiln are a big improvement over the ones shown in Olsen's book, because a shelf or ledge is built into the fireboxes and the grates slide in place. Since they don't have legs holding them up, they are reversible. This is a big plus because they can be flipped when they start to sag from the extreme heat.



photo: R.P. Washburne

A firebox loaded with wood on the grate and coals below.

It was also my experience, with my previous kiln, that the legs welded onto the grates were the weakest part of the design. They would fail during firings and I frequently had to re-weld them. It is normal and expected that grates will eventually fail from the intense heat. For longest life, high quality cold rolled steel at least 1" in diameter should be used for the grate bars. Axles or shafts are common forms of cold rolled steel. Low quality steel such as fence posts or rebar will quickly deteriorate. Ideally, deep-penetrating welding rods and a DC welding rig should be used to fabricate the grates. A homeowners AC unit and regular rods will work, but the welds will fail as the metal deteriorates a little more with each firing. My first set of grates, made by a professional

welder, lasted through about 150 firings over ten years, and I am now just starting on my second set.

The Kiln Frame

Of course the kiln is tied together with an angle iron frame. A frame is necessary for any sprung arch kiln, to keep the thrust of the arch from pushing out the side walls, but it helps keep any style of kiln tight and square, as well as protecting the corners of the kiln walls. The corners are tied together with rebar rods from the scrap metal yard with bolts welded on their ends. A removable rod goes across the front of the kiln, so it can be taken off for easy access when loading the kiln and then replaced for firing.

The Arch

If you've never done it before, building a kiln arch can seem like a daunting undertaking, but with good planning it's really not difficult. The subject is thoroughly covered in Olsen's book, so I won't go into the details here. Basically, there are two ways to design and plan a sprung arch: by using readily available arch tables, or by actually laying out bricks on the ground and working out what combination of bricks will be required to complete the arch. Either method works fine, but the second option is much more comfortable for the many potters who seem to suffer from "math phobia" when looking at tables of numbers and fractions.

For my kiln I used only standard straight insulating firebricks, and cut them into arch bricks on site with a table saw. I drew a life-size drawing of the arch curve on a piece of plywood (a portion of a circle with approximately a 2" rise per foot of span) and laid bricks on the line to fit. The advantage of

cutting your own arch bricks is that they can be cut to the exact angle needed to fit the curve. This is done by trial and error, adjusting the angle until the fit is perfect, and then once the exact angle is determined, running all the bricks through the table saw at the same angle.

Cutting insulating firebricks on a table saw is not a hard job, but it is very dusty, so a proper respirator should always be worn. The best saw blade for the job is an old dull blade that is mounted backwards on the saw. The plywood used to lay out the arch then becomes one end of the arch form for laying the arch.

The Chimney

My first Fastfire kiln had a hard firebrick chimney, with interior dimensions of 9" x 13½". I had problems with my first firebrick chimney because, through years of use, gaps developed between the bricks. All those little gaps add up, and the result was that the draft of the chimney was significantly reduced, just as if a passive damper had been left open in the chimney. So, if you build a brick chimney, be sure to build it tight, with reliable mortar.



The first eight courses of the kiln and the first five courses of the chimney/collection flue in place, with a hard brick lintel spanning the flue/chimney opening.

Photo: David Hendley

A Homemade Castable Refractory Chimney

By the time I was ready to build, I had come into possession of two 4'-long sections of a 15" inside diameter "Van Packer" brand cast refractory incinerator chimney. Years ago, a potter installed a kiln in a shopping center, and was required to purchase a UL listed chimney for the kiln. That pottery shop is long gone, but the chimney ended up, neglected and unused, in another potter's field. It would be horribly expensive to purchase such a chimney, but I bought it for less than a hundred dollars.

My problem was that the two sections added up to only eight feet of chimney, and I needed almost twice that height. Since one section of the chimney included a passive damper, I could not extend the bottom brick portion of the chimney because it would raise the damper above working level. It only made sense to continue beyond the incinerator sections with more sections of round castable refractory.

A nearby, recently closed firebrick factory was selling some leftover clay and materials. I was really only interested in a pile of white ball clay at the factory, but there was also, as part of the deal, a big pile of coarse fireclay and a pile of coarse bauxite grog. Both of these materials were too rough to use in a pottery clay body, but they looked like perfect ingredients for a castable refractory mixture. The bauxite, especially, seemed promising, because bauxite is alumina ore, which means that it should help resist ash build-up and deterioration in a wood-fired kiln.

Since I was rebuilding an old kiln, I also had lots of broken and crumbling insulating fire bricks on hand, so I decided to crush them into small pieces and incorporate them into the castable refractory mixture. The final sizes of the pieces ran all the way from about three-quarter-inch chunks to powder. I decided on a castable mixture of equal parts, by volume, of coarse fireclay, bauxite grog, crushed insulating



photo: Karen Hendley

The first section of Van Packer chimney with built-in damper is guided into place with a winch and gin-pole truck.



photo: Karen Hendley

The second section is lowered into position by means of a chain and pulley on a large tree branch above the kiln.

firebricks, and Portland cement. All I had to buy was some bags of cement!

The Forms

Finally, I already had forms on hand for casting a chimney. Taking up space in the garage were some sections of Sonotube cardboard concrete forms, left over from the long sections I had bought to make some display pedestals for my pottery booth. (“Sonotube” is the most common brand, but there are many “house brands” carried by big concrete supply companies.) I wanted to use the cardboard form, rather than steel pipe, for the outside of the chimney to reduce the weight of the finished chimney.



photo: Karen Hendley

Two sizes of cardboard concrete forms are cut to the same length.

The cardboard is thick and solid; much too tough to cut with a knife. The best solution is to draw a cutting line on the forms with a marker and cut them with an electric jigsaw or circular saw.

Using scraps of 24-gauge sheet metal, three clips are made to hold the two concrete forms together. The clips are cut with tin snips, and are bent around the edge of a 2x4. The “lips” on the end of each clip are formed with pliers.

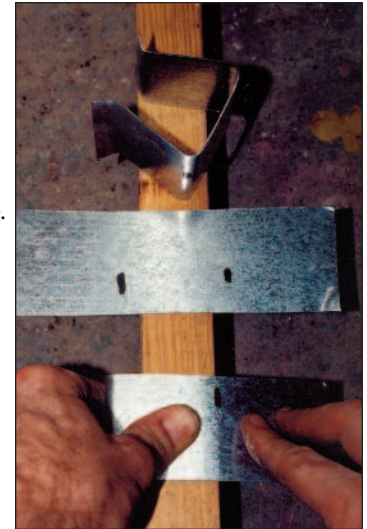

photo: David Hendley



photo: Karen Hendley

The three clips are installed, equally spaced, on the bottom edges of the concrete forms. (The forms will be flipped over before casting.) Another set of clips for the top edges of the forms might prove helpful, but, with care, the space between the two forms can be properly maintained without them.



photo: Karen Hendley

Crushed insulating firebricks, which will become part of the castable refractory mix, soaking in water.

Making the chimney sections proved to be straightforward and not difficult at all. To match the diameter of the existing stack, I used a 14" cardboard concrete form centered inside an 18" form. Thus the stack has a 14½" inside diameter, since 14" forms have a 14" inside diameter, but a 14½" outside diameter.

The ingredients were added with water in a wheelbarrow, and blended with a hoe for thorough mixing and consistency. The refractory mixture was placed in the space between the two forms and tamped in place with a 2x4. The chimney is 1¾" thick (18" minus 14 ½", divided by 2).

Installation

The most challenging part of the job turned out to be installing the finished sections, as 18" castable refractory chimney sections get too heavy to handle once they are more than a couple of feet long. The first section I made was three feet long. I thought that two men, walking up two ladders and standing on a shed roof, would be able to set this section on the existing chimney at waist height. I was dead wrong; it was all a helper and I could do to simply lift it off the ground for a few seconds. Luckily, there is a big limb from a huge oak tree over my kiln shed. I was able to throw a pulley over the branch, put a chain through the pulley and around the chimney section, lift the section up with my tractor pulling the other end of the chain, and swing it into place. I made the next section of the chimney 18" long, and, although it was a struggle, I was able to set it into position by myself.



photo: Karen Hendley

The cardboard forms are removed from the casting. This is best done after the castable refractory is solidly set, but still very damp, about ten to twenty hours after forming.



photos: Karen Hendley

The castable refractory is shoveled into the space between the two concrete forms and tamped solid with a two by four. A gloved hand is the best tool for placing the material in the form with minimal spillage. Remember that, because of the cement, the mixture is caustic.

Then, the top of the casting is troweled smooth with a putty knife.



photo: Karen Hendley

A small batch of "patching mortar" is mixed, for patching any air voids in the chimney casting. The mortar mixture is the same as the castable refractory mixture, except the crushed firebricks are replaced with more grog.

In some situations it might make sense to cast a chimney in place. This would take care of the problem of moving the heavy sections into position. It could also eliminate the need for the outside piece of cardboard concrete form, as the chimney could be cast directly into a section of metal pipe. The problem with this method is that it becomes difficult to adequately ram and tamp the castable mixture once the chimney section is more than a few feet long. The top several inches of my chimney were cast in place, using a metal pipe for the outside form.

Firing It Up

The cast chimney has worked great. I used it for three firings with the sections simply set in place (minus the top few inches that were cast in place). Having no support for the stack, of course, is not really a good idea, because a swift wind in a thunderstorm could conceivably blow it over. I had in mind installing four pieces of lightweight angle iron vertically around the circumference of the stack, binding them tight around the stack with cable, and then running guy wires from the top of the iron to the ground. I decided instead to go ahead and encase the cast sections inside a galvanized steel duct pipe anchored with guy wires. The pipe was fabricated at an air conditioning shop out of 20-gauge material, 18½" in diameter to assure that it would freely but snugly slip over the cast stack. At a cost of about \$11 a running foot, this proved to be the most expensive part of my chimney. The pipe offers some weather protection for the cast chimney, but I think the angle iron and cable arrangement would also work fine. After about 150 firings the chimney is still in good condition. Hairline cracks appeared in the castable after the first few



photo: R.P. Washburne

Clearing excess coals from the firebox. Three or four times during a firing, coals must be removed from the fireboxes, to maintain adequate air space under the grates. A homemade all-steel hoe and a standard shovel are used to fill a five-gallon steel paint bucket. This operation requires extra heat protection: heavy-duty gloves, welding helmet, and heat-reflecting aluminized apron.

firings, but they have not subsequently grown larger. The commercial chimney sections also have hairline cracks running through them, and have become somewhat fluxed and deteriorated through the years.

I found that a castable refractory chimney has some desirable characteristics compared to other types of chimneys. The heavy mass of the stack, compared to a ceramic fiber sleeve, helps, I think, to induce a good lively draft through the kiln in the early stages of the firing. An advantage over a brick chimney is that the castable stack is airtight. Brick chimneys can develop cracks that serve to slow down the flame draft through the kiln, causing unintended reduction.

The Bottom Line

My chimney cost me next to nothing to make, but here is an estimate of the supplies needed and costs for making an 18" diameter cast chimney with materials purchased from normal sources. Note that a gas-fired kiln of a similar size (about 35 cubic feet of stacking space) could use a smaller diameter chimney with a proportionally lower cost. Also remember, these are 1998 prices.

This adds up to a total of about \$375 for a 12'-high stack, or about \$31 a foot, a reasonable price compared to other materials used for kiln stacks. The cost per foot would be a little higher if the entire 12'-long sections of the forms were not used. Of course, my cost, by using leftovers and scraps, was next-to-nothing.



photo: Karen Hendley

The completed kiln, with a steel shed and roof built over the kiln. Note that, for safety, the roof as well as the shed frame are flameproof metal.

2' of brick chimney, 8' of commercial incinerator chimney including a passive damper, and 5' of homemade castable refractory chimney.

Cost of Materials

14" and 18" diameter cardboard concrete forms: about \$3 a running foot. The forms are sold in 12-foot sections, so the cost comes to about \$75 for any chimney up to 12 feet high.

Portland cement: about 25 to 30 pounds per foot, for a cost of about \$2 a running foot.

Fireclay: about 40–50 pounds a foot, times the cost of the clay, about \$5 a foot.

Coarse grog: about 40–50 pounds a foot, or about \$6 a foot.

Crushed insulating firebricks: free, from an old kiln or a potter friend.

Galvanized steel duct pipe: \$11 a running foot.

Guy wire cable and connectors: about \$10.

*David Hendley can be found at:
farmpots.com*

FIRING SCHEDULE David Hendley's Fastfire-Style Wood Kiln				
CLOCK TIME	ELAPSED TIME	FIREBOX #1	FIREBOX #2	PASSIVE DAMPER
6:15 am	0:00	closed	open - start fire on floor, small sticks, working up to larger scraps	closed
6:30 am	0:15	closed	5 oak 2x4s on floor, close door except for small opening	closed
7:30 am	1:15	closed	open door, stoke slowly	closed
8:45 am	2:30	open door, stoke slowly (start with coals from firebox #2)	closed	closed
10:00 am	3:45	stoke medium rate	open - stoke medium rate	closed
11:30 am	5:15	stoke very heavy	stoke very heavy	open ½
1:00 pm	6:45	stoke continuously clear excess coal bed	stoke continuously clear excess coal bed	open ¼
3:00 pm	8:45	stoke continuously clear excess coal bed	stoke continuously clear excess coal bed	open ¼
MOVE TRICK BRICK WITH STEEL ROD				
4:15 pm	10:00	clear excess coal bed	clear excess coal bed	closed
4:45 pm	10:45	put excess coals back in firebox, close cover	put excess coals back in firebox, close cover	closed
HOSE DOWN AREA WITH GARDEN HOSE PUT KILN SHELF LID ON TOP OF CHIMNEY				

Steve Mills'
Double Cross-Draft Kiln

Over the years I have been involved with many different sorts of fuel burning kilns, starting with gas, which I was involved with right at the beginning of my career. I would probably have stayed in that simple groove had I not, by accident, become involved in a BBC2 TV project, reconstructing an Iron Age Village. As the “pottery expert,” I had to help the inhabitants find a way of firing the pots they were making for everyday use, and so I was pitched headfirst into the, then mainly unexplored, mysteries of primitive firing. By the end of the project I was hooked and have spent the subsequent years exploring small scale effective firing techniques.

The kilns that I will be describing here are to be looked upon as a starting point for your own journey. Building and then modifying these projects to suit your own needs is one approach, but perhaps it is better to read and observe, and then, coming to your own conclusions, build something which is perhaps radically different. If at the end of all this you come to the conclusion that building a good kiln is not rocket science, but something anyone can do, then I will have achieved my objective.

A Bit of History

I have always known this type of kiln as a “Philosopher’s Kiln,” as firing it is a comparatively relaxed affair, allowing time for observation, discussion, and enjoyment of the process. This project began from a design more normally associated with raku kilns. The utter simplicity of it is its greatest strength, and it lends itself to considerable personal modification.

Rather than give detailed step by step instructions, I have chosen to illustrate various stages in the building of this sort of kiln, showing variations of each type, with comments alongside.

Here are the beginnings of two versions of the same basic form. The top one employs two “mouseholes” on each side for secondary air to enter, with primary air coming in through the ground level hole in the front.



Note the mouseholes on the side.

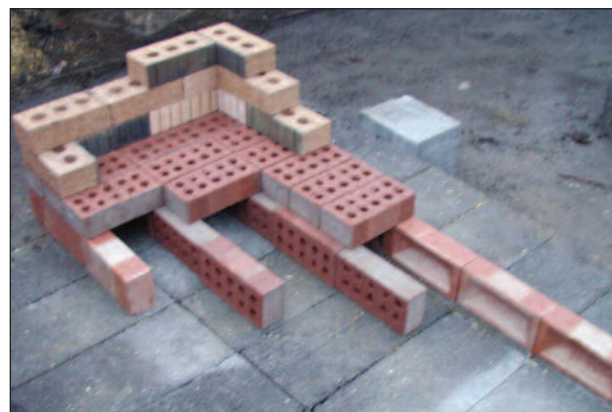

Perforated bricks allow the air to enter this kiln.

In the lower picture, the firebox floor is made up of perforated bricks which is the only entry for air. Although there is the same hole at the front of this kiln, it is purely for post-firing cleaning out, and is blocked up during firing.

The advantage of the perforated floor is that it positively encourages combustion of the embers over the entire floor thereby giving much better pre-heating and consequently even better fuel economy. The two inner lines of bricks supporting the floor are also perforated to encourage air cross-flow. The outer lines are plain house bricks.



photo: Steve Mills

In this picture you can see the mouseholes on one side and the primary air entry at the front.



photo: Steve Mills

Here you can see the 3 channels which are the primary air entries in this design. The channels extend right through to the other end to provide enough for full combustion (see the notes on proportions at the end of this section). During firing, one or more entries can be closed at either end to help vary the atmosphere inside.



photo: Steve Mills

The upper hole here is for stoking. The lintel is made from thick kiln shelf. I have used cast firebrick pieces before, but they lack strength and are short-lived.

On the subject of stoking, one problem with a long firebox is that fuel needs to be thrown to the back in the latter stages of a firing. This has a punishing effect on the back wall, and has led in the past to bricks being knocked out of it during a firing. The solution is an inner replaceable loose brick wall which I call the “thump wall,” just visible below (arrow). Note also the ends of the two fire bars protruding from the wall on the right. The theory behind this is explained in the section on firing.

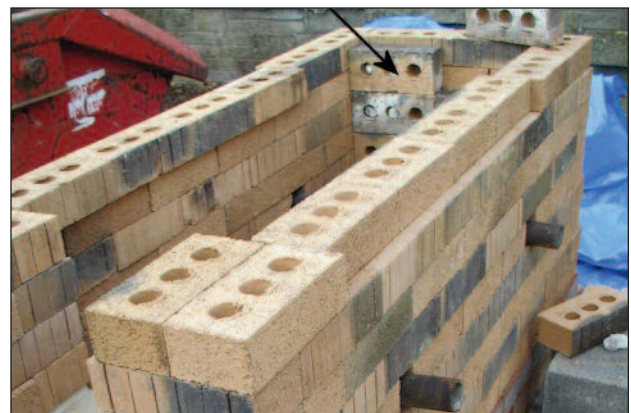

photo: Steve Mills

The thump wall.

The kiln below has reached the stage where the firebox is complete and the pot chamber and base of the chimney can be built.



photo: Steve Mills

The firebox is complete.

The Pot Chamber

Notice that the last layer of bricks has been corbelled in to support the pot chamber base shelves. Notice also the gap at the end of the shelves to allow fire entry from the firebox. In this case it is about 9" deep and the width of the kiln.

As you will have also seen, the pot chamber base shelves are quite thick. This is necessary to provide strong support for the wares packed in it, and also to give some degree of insulation as heat can be rapidly lost downwards. In some builds I have done the only shelves available were silicon carbide, which are very thin, therefore it was necessary to make up a sandwich of two layers of shelves, with ceramic fiber in between, to achieve the required insulation.

The pot chamber and base of the chimney are now started, and you can see the two support bricks for the chamber side of the chimney. Unless you can use pre-fired and shrunk bricks

for this, spacers will need to be inserted after the first firing to level things out again, as their shrinkage is considerable.



photo: Steve Mills

If possible, use pre-fired bricks as your support bricks.

The mug of coffee is not part of the kiln, but it is, of course, an essential part of the process!

Chimney Height Is Adjustable

So here we are with this kiln virtually finished and the chimney built. This style of kiln has the advantage that its height can be adjusted up or down during the firing while you fine tune its performance.

In fact, the chimneys of all the kilns presented here are approximately the same height and internal diameter/dimensions; these were originally arrived at more by happy accident than careful calculation! However, at the end of this article their proportions are explained. The advantage of the removable chimney is that it is much easier to wrap the whole kiln up against the elements without it in place.



photo: Steve Mills

Chimney height is adjustable during firing.

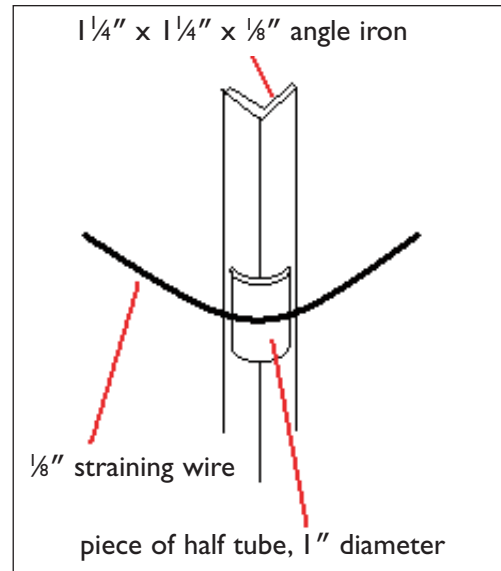

photo: Steve Mills

This will help ease the stretching of the wire.

Securing the Structure

It is now important to tie the whole structure up with angle iron at all corners, bound together with fencing wire and barrel tensioners (turnbuckles). I have found it useful to insert half-sections of steel tubing on the corners to ease the stretching process of the fencing wire.



photo: Steve Mills

Look for the 2 tensioners/turnbuckles on the left-hand side of the kiln.

Firebox Doors

There are as many solutions to how you approach making a firebox door as there are days in a year! The easy solution is an old kiln shelf held in place with a piece of metal and lowered onto a brick column when stoking. The problem with that is it is very easy to drop it in the flurry of stoking, and they don't bounce!



photo: Steve Mills

See? They really don't bounce!

The solution I have arrived at with the latest build involves 4 bits of angle iron, 3 threaded rods, 2 gate hinge pins, 2 bits of tube, and 4 insulating firebricks. The fire bricks have slots cut in them for the angle iron to sit in, and the hinge pins just go through two plain holes in the ends of the angle iron. A simple catch could be made to hold it shut. This one stays shut without needing one, more by luck than intent.

The last thing I do is to make up a mixture of equal parts of scrap clay, sand, and sawdust. Initially this is used to fill up any cracks or unevenness in the joints between the bricks. It can also be used as an insulating layer on the outside of the kiln. I also use it as a seal between the pot chamber and the thick shelves that make up its lid.



photo: Steve Mills

A hinged door is easily made with angle iron.



photo: Steve Mills

Gate hinge pins allow the door to swing.

Below is a drawing of the brick chimney'd kiln as it evolved before the perforated floor version; useful for brick counting and with some detail notes as well.

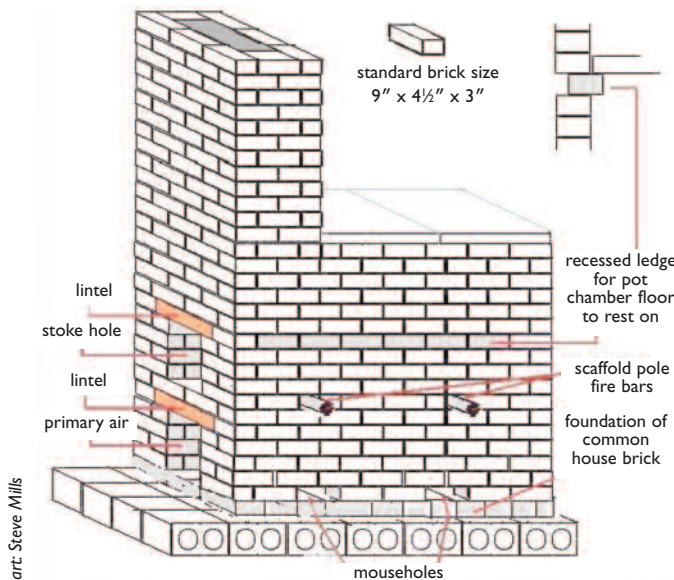

Steve Mills' kiln plan.

The cover for the pot chamber is, as you can see, made up with kiln shelves. As this is not load bearing, almost any refractory slab able to take high temperatures can be used, though if they are thin, some form of insulation should be added. The cheapest is a thick layer of equal parts of clay, sand, and sawdust. The easiest is ceramic fibre, preferably the body-soluble type, though you should always wear a respirator and gloves when handling fibre, whatever type it is!

It is a good bet that if you can find a buff-coloured house brick, then it will fire to a much higher temperature than common red brick will. This is certainly the case where I live near Bristol in the UK. Just north of that city there are extensive clay fields of a highly refractory

clay from which are made the bricks which I use for my kilns. They are not as heavy and dense as hard firebrick, but they are very cheap and work very well for me thank you!

Note: In nearly all the kilns of this type I have built I have used brick locally available to me, the dimensions of which are 9" x 4½" x 3". All the plans here are based on these measurements. This does not necessarily apply where you are, as I found out (the hard way) recently when building one of these in a different part of the UK. Here, some of the local brick I used were smaller, not by much, but enough to alter the basic proportions of the kiln the wrong way, and I noticed a bit late in the day! So let your watchword be:

“Beware of local variations!”

Additional Information

Although the design of this kiln was not calculated in this fashion, examination of its proportions will show that it conforms to several of the principles laid down by Fred Olsen in his excellent *Kiln Book*. In Chapter 3, Principles of Design, Principal 3, the ground rule for the grate/flue areas for wood-fired kilns is a ratio of 10 to 1; the area of the grate being ten times that of the area of the flue, however he modifies this rule to 7 to 1 as a result of experience, as this makes the kiln much easier to fire: “It allows for a more forgiving firing technique, fires faster when needed, adjusts for altitude, and allows for adjustability in altering flues, chimney height and dampering.” Thus the grate area of this kiln is 1134 square inches, which gives us a flue area of 162 square inches. In Principle 6 Olsen asserts, “for natural draft kilns there should be three feet of chimney to

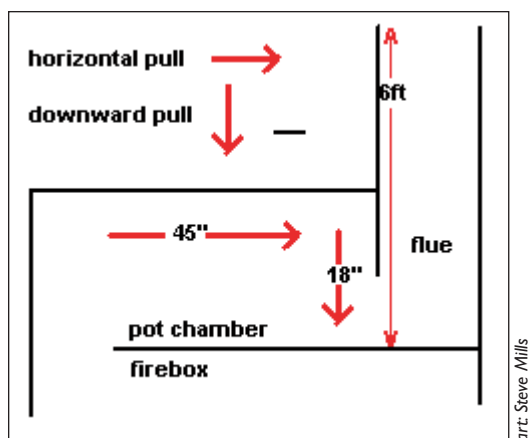

Steve Mills' pot chamber, firebox, and flue.

every foot of downward pull, plus one foot of chimney to every three feet of horizontal pull.” In this kiln we have approximately 18” of downward pull which gives us 4’ 6” of flue, and 45” of horizontal pull, which theoretically adds another 15”.

Since the calculation for height of chimney starts at the point at which the gases leave the pot chamber, you can see that the proportions are just about right at a total of 6 feet. Where there is some deviation from Fred’s Principles is in the latest incarnation of this kiln. Going back to Principle 3 he states that the inlet and exit areas should be identical, in this case 162 inches.

In the case of the Potfest and previous kilns, that balance was correct, as all primary air entered the kiln through a right-sized hole just below the stoke hole. In the latest version where all primary air comes in through the firebox floor, the combined area of the three vents at either end of the kiln only totals 135 square inches. Nonetheless it fires very efficiently and does not seem to miss those 27 inches! However as the kiln is entirely constructed of dry laid bricks, with nary a spot of mortar or any other joint sealant, I suspect that the missing 27 inches are more than compensated for by a lot of small gaps in the brickwork!

You may notice in all variations in this kiln that there is no damper. It was accidentally omitted in the first version, but wasn’t missed, and I have rarely found the need for it since. Any adjustment needed such as reduction, or slowing down the firing process, can be very effectively achieved by controlling the primary air and/or by under- or over-stoking. Sealing the kiln after the firing is done by closing off the primary air and putting a lid on the chimney. In the case of a metal chimney, this is removed first and the base is sealed with a spare kiln shelf.

Materials for Kiln

- 27 hollow concrete blocks
(see note at end of list)
- 360 fire bricks or similar
- 56 perforated bricks (firebox floor)
- 20 common house bricks
- 4 pieces angle iron 51" by 1½"
(130 x 3.8 cm)
- 2 pieces thick kiln shelf 12" x 6" x 2"
(30 x 15 x 5 cm) or fairly close to those
dimensions, plus odd scraps of kiln shelf
for packing out
- 1 coil medium grade galvanised
fencing wire
- 4 galvanised turnbuckles
- 4 pieces 2" x 1" tube, halved (10 by 5 cm),
8 pieces in all.
- 2 pieces heavy-duty steel scaffold tube 30"
long (76 cm)
- 6 heavy-duty kiln shelves 18" x 18" x 2"
(45 x 45 x 5 cm)
- 1 length of steel tube (preferably stainless)
48" x 14" (122 x 35 cm) flattened into
an oval approximately 9" (23 cm) wide
on its narrowest dimension for
the chimney
- Scrap clay
- Sand
- Sawdust

Tools

- Heavy-duty gloves
- Rubber mallet
- Bolster chisel and lump hammer (4 pound)
- Angle grinder and stone cutting blades
- Spirit level
- Two pairs strong pliers
- Heavy-duty wire cutters
- 48" x 2" x 2" piece of straight timber
- 3 litres thick Batt wash and a coarse brush

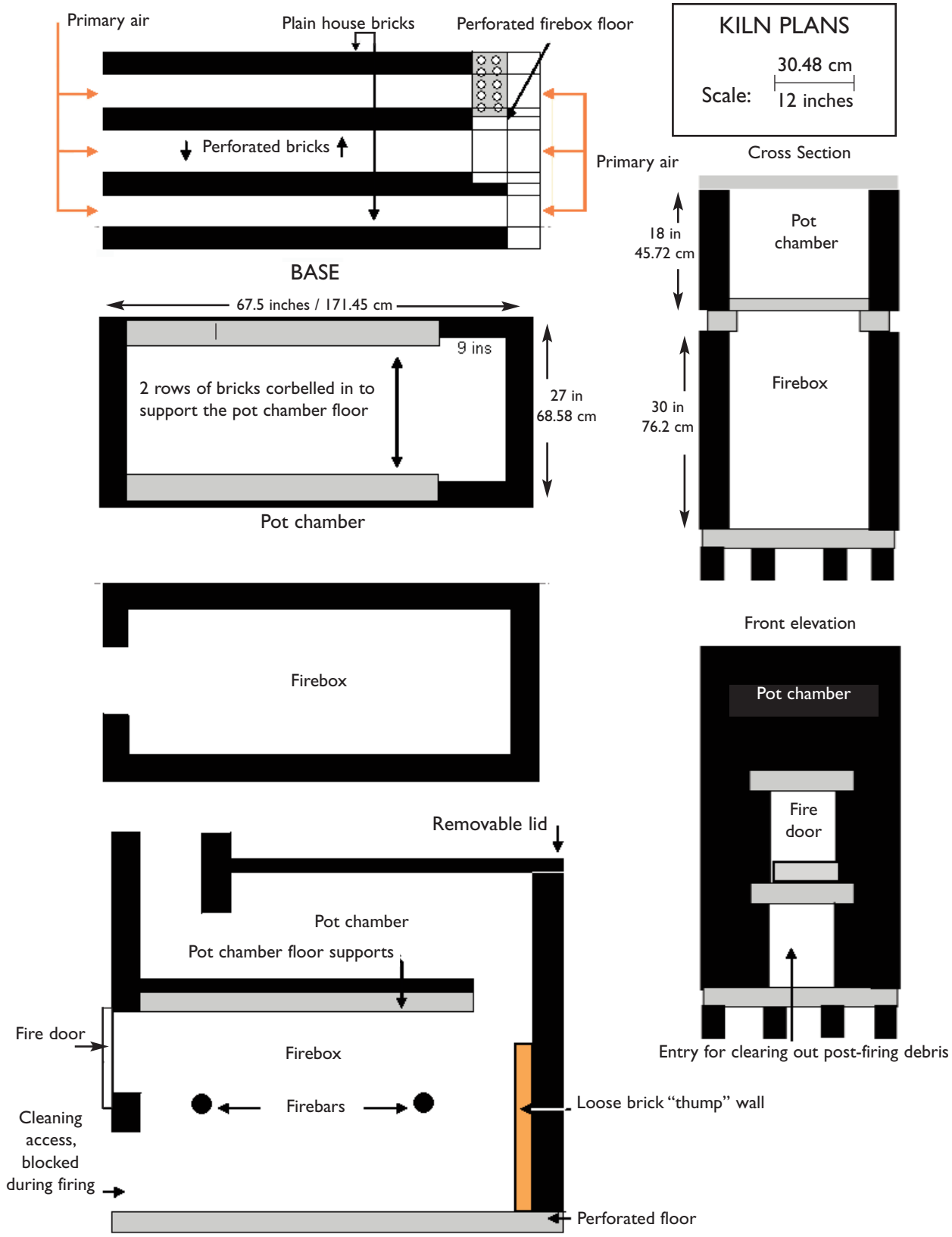

art: Steve Mills

Door Construction

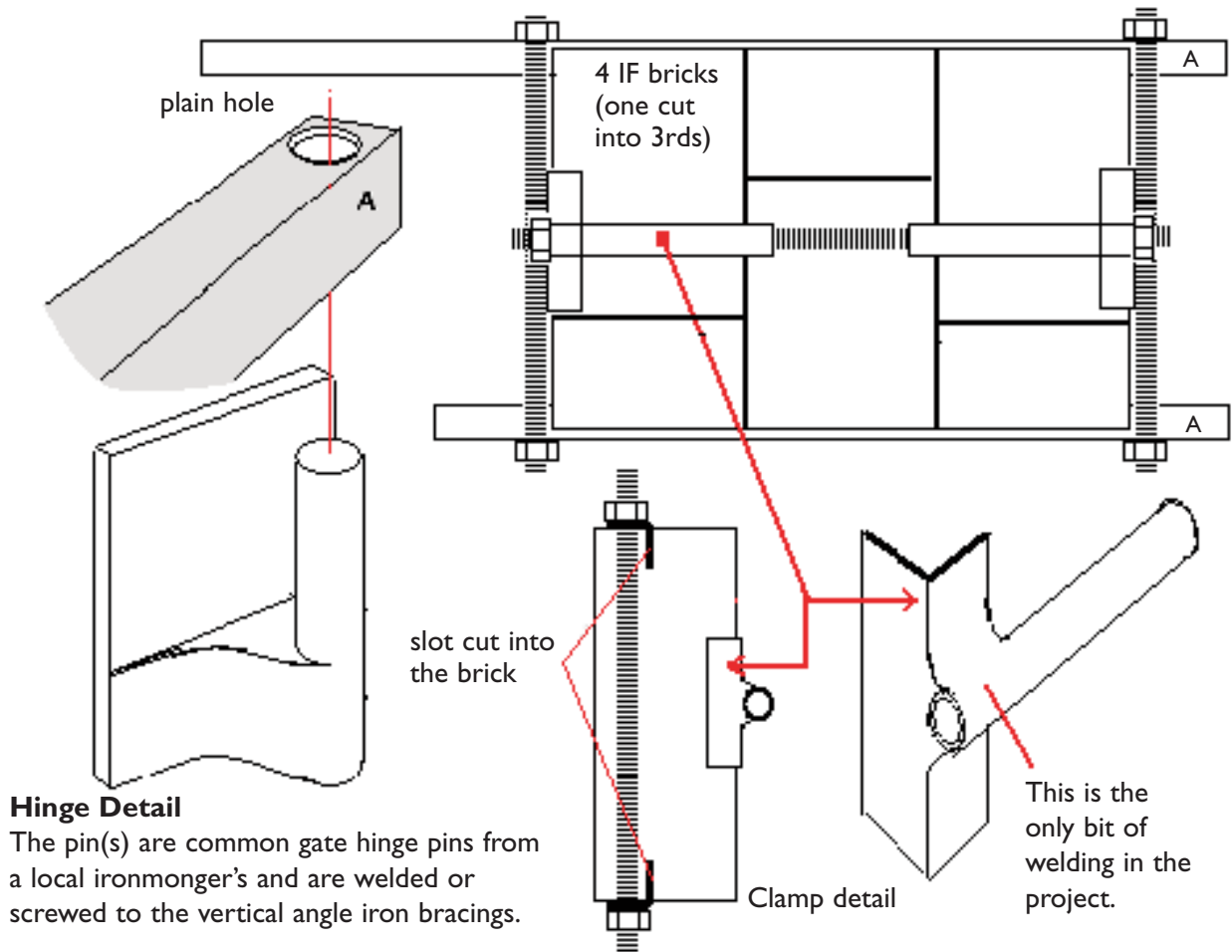

Hinge Detail

The pin(s) are common gate hinge pins from a local ironmonger's and are welded or screwed to the vertical angle iron bracings.

slot cut into the brick

Clamp detail

This is the only bit of welding in the project.

art: Steve Mills

Materials for Firebox Door

4 pieces of angle iron, one the same length as the width of the kiln, the other 2/3 of that, and 2 pieces the height of the firebox door hole plus about 2" (5 cm).

3 threaded rods, one 1" x 12" (30 cm) long, the other two about 15" (47cm) long.

2 gate hinge pins.

2 bits of tube.

4 insulating fire bricks. The 2 pieces of tube are welded to the 2 shortest lengths of angle iron (see picture). This is the only bit of welding involved in the making of this kiln. Note: Hollow concrete blocks make sense as the foundation for a kiln; any rising moisture from the ground beneath is dispersed by airflow through them, and should the kiln be built on a vulnerable surface such as tarmac they prevent that from degradation through heat!

The Firing and Firebox Design

In any fuel-burning kiln, there is one overriding rule, and that is, the hotter the firebox the more efficient and effective the firing. To achieve this end there have been many differing approaches, but in the end they all boil down to one of two designs. These two basic types are the standard firebox and the Bourry box.

The Standard Firebox

In the standard version you have a longish firebox leading into the pot chamber, divided horizontally by a row of fire bars. The fuel is loaded onto the bars, and the space below forms the ash pit. In its simplest form, this is basically an inefficient design. There is too much space beneath the bars, allowing cold air to enter the kiln, even with a good bed of embers. And with the air being drawn in over them, it will have relatively little effect on the fuel above it which makes retaining heat in that area very difficult. Also, because the fire bars are in a horizontal plane leading to the pot chamber, fuel resting on them cannot burn efficiently because the flames are travelling along its length and preventing air from reaching the rest of it.

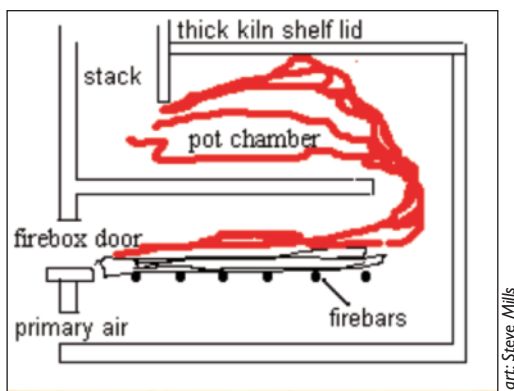

Standard firebox.

The Bourry Box

The Bourry box design is much more efficient, but it does demand that all the fuel used is of the same length—there is little allowance for variation. As this kiln is designed to use waste, recycled, or scrap timber for fuel, what you can get is what you use; there is little choice.

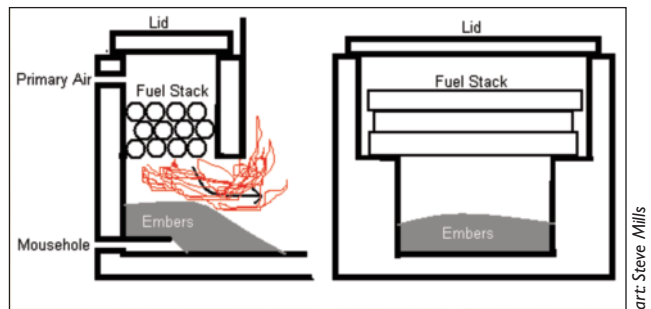

Bourry box. Side view and front view.

A Variation on the Standard Firebox

To overcome these two problems I use my own version of the standard firebox in the kilns I build. Instead of a row of fire bars I have just two, the first a quarter of the way into the box, and the second the same distance from the other end of the firebox. With this arrangement fuel is thrown in so that it either tilts forwards off the front bar, or tilts back from the back bar.

With the fuel tilted at an angle to the direction of air flow, air reaches it comfortably, and is prevented from going through the firebox without touching anything, because the fuel is in the way. Consequently the fuel is able to get the proper pre-heat from the embers, and also burns along a broad front without obstruction. This means optimal release of heat from a small quantity of fuel.

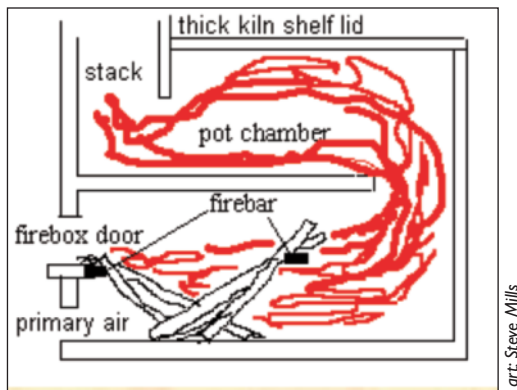

Steve Mills' version of the standard firebox.

In the case of a long narrow firebox such as in a small low-ceilinged anagama or tube kiln, where you have a firebox which is wide rather than deep, the technique is to angle the fuel across it, almost from side to side, to create the same broad front of flames. Again, this achieves the same aim of maximising the effective combustion of a given quantity of fuel.

With any firing there is an initial warming up period, gently building heat within the entire structure. For this I tend to use largish lumps of timber which burn steadily and unspectacularly. Once warmed through, I can start using thinner timber, always in small quantities, gradually increasing the rate of temperature rise until I see evidence of red heat in the pot chamber. At this point I change to very thin timber in small quantities, stoking quite frequently, the objective being to raise the firebox temperature to the point where the fuel explodes into flame rather than “catching fire.”

Note: At all times it is essential to monitor the amount of fuel that is fed into the firebox. Too much and you get great clouds of smoke, a clear indication that there is too much in there and it cannot burn properly. There is always an initial burst of smoke as you stoke, but if you've got your quantities right, this should clear relatively quickly and be followed by a short period of cleaner burning, and then an absolutely clean burn.

When you get to this point, open the door and check how much there is left unburnt, if any. Throw one or two small bits in—or maybe not—either way, be watchful and try to guess what the kiln needs.

Take notes, if necessary, and if you can employ a pyrometer and thermocouple to aid your deductions, so much the better. You will notice that the temperature fluctuates quite strongly; this is normal; what you are aiming to do is to get the end point temperature when you have to re-stoke a little bit higher each time, and maintain or exceed it after the next stoke.

This won't always work; the condition of the fuel has an enormous bearing on the efficiency of the firing. Fuel must be very dry and well seasoned to perform properly. One of the advantages of using scrap timber such as building site reclaim, palettes, old floorboards etc., is that you know they are seasoned, and all you have to do is make sure they are thoroughly dry.

Damp timber won't burn properly, resulting in an increasing ember bed, which, instead of burning efficiently, eventually clogs the firebox and can stagnate the firing. The partial answer

is to rake out the excess and introduce really dry fuel into the firebox. The real answer is to be prepared with lots of really dry wood, stacked so that it can continue to dry by open stacking in a covered store. If you are going down this wood-firing road you will realize that a proper wood store is as important as the kiln.

This may sound a bit “cosmic,” but I have always maintained that the kiln will tell you

what it wants, all you have to do is learn the language, and the old kiln-firing saw “more is less” applies in full measure at all times.

© Steve Mills 2004

Note: If you wish to reproduce any of this, you may do so provided you fully acknowledge its origin and its author together with what you choose to reproduce.

*Steve Mills can be found at:
pottersbristol.com*



photo: Steve Mills

Not too little.



photo: Steve Mills

Not too much.



photo: Steve Mills

But just right!

**Making Something from Nothing:
A Cast Catenary Arch Kiln with a
Sawdust Injection Burner**
by Pat Lindemann

I come from a long line of research junkies and scavengers and so does my husband. Long before the actual building ever began on this kiln, I researched and gathered materials.

Fuel

“Sawdust doesn’t burn—that will never work.” These were the words I first encountered when I considered aloud building a sawdust kiln. And truly, most realize that sawdust smolders and smokes and certainly doesn’t burn hot enough by itself to reach the high temperatures that a kiln requires.

The idea of this sawdust burner is that you use it in partnership with propane. Red heat (1000°C) is reached with propane, and then sawdust is blown into the kiln, where it literally explodes into additional heat, providing the push to stoneware temperatures. Wood ash is deposited on pots during the firing, and adding salt and/or soda ash to the firing can be accomplished by mixing it in with the sawdust.

My first experience using sawdust as a fuel was smoke-firing some pots, following the diagram and instructions that Robert Pipenburg provided in his book, *The Spirit of Clay*. I was so pleased with the results, and the availability of sawdust, that I wondered if more could be done with it. Right around that time, I ran across an article written by Lowell Baker in a *Ceramics Monthly* magazine about a sawdust injection burner.



The completed castable refractory arch.

In *The Art of Firing*, Baker wrote a section on the sawdust burner, and included detailed diagrams and narrative about constructing and firing the burner. It was from this chapter that I made notes and began collecting equipment and materials to construct the burner.

With the current prices of fossil fuels and the ever-increasing cost of firing pottery, using a burner of this type is an idea worth considering. I live in a heavily wooded area of the Black Hills, where sawmills are in every town. Sawdust can be had for a very low price, sometimes merely the cost of coming and hauling it away. In terms of how much sawdust is required for a firing, Baker says that one should have 2–3 times the volume of the kiln on hand.

An added bonus was having the opportunity to hear Lowell Baker speak about the sawdust burner at a NCECA conference. After having a chance to visit with him later that afternoon, I was convinced it was worth a try.

Building Materials

A castable refractory was my choice for kiln body. It seemed economical, the materials were not difficult to acquire, and I could mix it as needed.

I tested several castable recipes, and finally settled on this one:

Castable Refractory Recipe

1 part damp sawdust

1 part cement

2 parts Hawthorne Bond fire clay

1 part 30 mesh grog

1 part Oil Dri (diatomaceous earth)

I made test bricks out of this mixture and put them into every firing of my propane kiln for a summer. They didn't crack or show wear.

I mixed this mixture in a wheelbarrow on site, with a hoe. I first dry mixed everything together and began adding water, a half gallon at a time. When the mixture was wet, and held together when you made a ball of it, I stopped adding water. If you have the mixture too wet, it will run right out of the form. If it's too dry, it will not pack and hold its shape. Experiment with the right amount of water.

A note of caution: Wear rubber gloves as the cement can be very hard on your hands. Also wear a respirator when you measure and mix dry materials to avoid breathing in the dust.

Building Procedure

STEP 1: Determine the Size

Your work cycle should determine your kiln size. If you make a few pieces and want them finished right away, then you need a small kiln. I needed a bigger kiln. My work cycle had increased to where I could fill my smaller kiln in two days. I wanted to lengthen my work cycle to a few weeks or a month. I wanted a kiln with 20–30 cubic feet of stacking space. Taking the catenary arch formula for cubic feet is a helpful way to determine size, once you know the capacity you want.

$$\left(\frac{4}{3} \times \text{Height}\right) \times \left(\frac{1}{2} \times \text{Width}\right) \times \text{Length} = \text{Cubic Inches} / 1728 = \text{Cubic Feet}$$

STEP 2: Determine the Shape

There are a variety of shapes you can make a kiln, and for a while I even considered making this kiln round. Because I was using a castable, I didn't have to worry about the shapes of available bricks or cutting the bricks. I wanted a durable shape that could handle the stress. I chose a catenary arch, reasoning that it is a beautiful form and lends itself to being formed with a castable.

STEP 3: Choose the Location

Location was easy. I chose up on the hill, near my studio, away from the trees. I leveled the area with fill dirt and then sand. I laid out a foundation of concrete blocks about 6" larger than the footprint of the kiln. Don't forget to include the chimney in your footprint.

What I wish I had done differently: I wish I would have made the foundation a bit higher and a bit bigger. Packing the fill dirt better would have been good too, as some of my

concrete blocks shifted a bit as the kiln was built.

STEP 4: Build the Catenary Arch Form

My husband and I built a large form for the kiln, essentially enclosing the intended interior of the kiln in plywood and masonite. We extended the end pieces of the mold 5" beyond the closed form (*figure 1*), thus planning for the walls of the kiln, which are 5" thick.

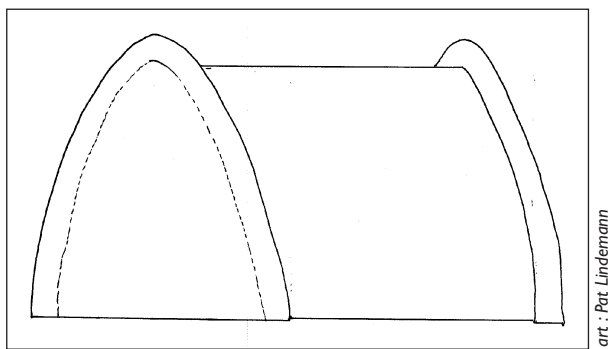

Figure 1.

STEP 5: Build Form for Floor and Cast Floor

On the cement block footing we built a form, much like for cement, the size and shape of the kiln footprint. In the form we placed a layer of newspaper, then tin foil, and then 1" ceramic fiber.

We mixed several wheelbarrows of castable mix (excluding the Oil Dri because it made the mixture too rough to trowel), pouring each into the floor form. When the form was half full, we laid the tubing for the Y-channel, which will transport the sawdust, bedding it into the wet castable. All that remained was to mix several more wheelbarrows of castable to cover the tubing and then trowel the floor smooth. We allowed the floor to dry and cure for two weeks before beginning the kiln body.

What I wish I had done differently: My floor cracked over the Y-tubing, as it dried and shrunk—not right away but about three months later. I wish I had made the tubing removable and pulled it out after the floor set.

STEP 6: Place the Wooden Arch Form in Center of Floor

After constructing the arch form with plywood and masonite, we placed it carefully in the center of the cast kiln floor. Because we were working with raw castable the whole time, it was easily marred and gouged. Being careful in the beginning saved lots of patching in the end.

STEP 7: Cast the Arch

By placing a 1" x 8" board across both extended edges of the plywood on the arch form and fastening with removable screws, you form a mold (*figure 2*). Then it was just a matter of placing the shutter or board on the arch, fastening it in place, filling the void with wet castable mixture, waiting for it to harden, and moving the shutter up on the arch and doing it all over again. You repeat this process until you have completed the arch and can remove the wooden arch frame. I began at the bottom of one side, and then at the bottom of the other side of the arch. I alternated sides until I had only the top remaining, which tied the whole thing together. This allowed for shrinkage of the walls and didn't put undue stress on the walls or arch as it dried.

What I wish I had done differently: I wish I had put pieces of PVC pipe in as I raised the walls to serve as peepholes. I cast the arch solid, and had to go back and drill out peepholes.

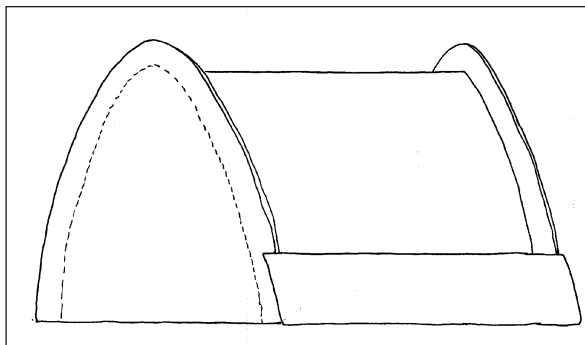

Figure 2.

STEP 8: Cast Back Wall of Kiln Body

The back wall was built in a similar manner to the arch. We cut 2 boards, each about 8" high. One of the boards fit against the interior side walls of the kiln, and the other went across the open end of the kiln. After drilling 2 holes in each of the boards, we slipped two 7" lag bolts and nuts in the holes (see figure 3).

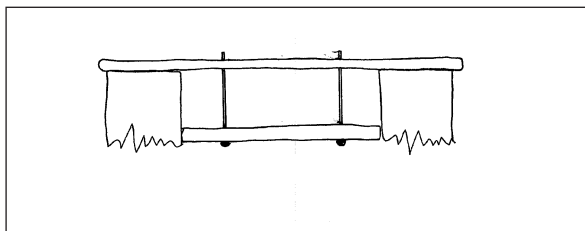

Figure 3.

This created a framework to fill with castable for the back wall. Again, it was a process of starting at the floor and building it up 8" at a time. Moving the 2 boards up each time and refastening the bolts is similar to building the arch, with one difference that will become obvious right away. As you raise the height of the boards, the interior space for the inside board is reduced by 2–4 inches each time. This requires you to cut the board each time you raise it, to accommodate for this.

An alternate plan we considered was to cut a piece of plywood to fit the inside of the arch, and fit it about 5" in. Drill a series of holes to receive the lag bolts at each level. Use one board across the end.

We cast the flue opening and burner port in the back wall at the floor level. Using 5" pieces of board, we made small boxes the sizes of the burner port and flue, and fit them into the mold, pouring the castable around them.

STEP 9: Cast Bricks for Kiln Door

I cast bricks for the door of the kiln. Using the same material as the rest of the body was important, because I knew the body was going to shrink during the first firing, so this way it could all shrink together. The mold I built held 6 bricks. It took about one wheelbarrow full to fill the mold, so in three days I had enough bricks. When the bricks are new, they are easy to cut. We cut the end ones to fit the mouth of the arch, building them up as we went and numbering them with a cobalt/water mixture.

STEP 10: Build the Chimney

The chimney was built with high temperature hard firebrick. It took 165 firebrick to build to the height of the kiln itself. We used flue liners with concrete blocks for the last 6' of height. There are two "soldier" courses in the bottom of the chimney to bring it up to the height of the flue. Using a mortar of fireclay and water to bed each of the firebrick helped the chimney to be airtight. I followed the pictures and diagrams from *The Art of Firing* by Nils Lou. A kiln shelf was used for the damper.

STEP 11: Cover Kiln with One Inch of 2600° Ceramic Fiber

For additional insulation, I covered the arch and the back wall with ceramic fiber. For a kiln of this size I needed two rolls of one inch 2600° fiber. It was a simple matter of measuring from the bottom of the arch wall, over the top, to the bottom of the other side, and cutting fiber to lay over the top. At the end of the arch I wrapped the fiber around the corner of the arch against the back wall, and cut to fit.

STEP 12: Place an Outside Covering of Metal Over Fiber for Protection

If you cover a kiln with fiber and it is outdoors, some type of weatherproofing is necessary. Some choose to build a shed. We elected to cover the fiber with steel. If you choose this method, be sure to anchor the steel shell so it does not blow away.

STEP 13: Build the Fiber Door to Cover Bricks

Something you may want to consider is to build an additional layer of fiber that can be placed in front of the bricked up doorway of this kiln. I felt that there needed to be additional insulation

at the doorway. To do this, we cut steel in the shape of the doorway of the kiln and attached fiber to it with clay buttons and nichrome wire. I put a handle on each side so I can lift it into place.

STEP 14: Construct the Sawdust Burner

This is a forced-air burner, which blows the sawdust into the interior of the kiln. As mentioned earlier, a Y-channel was cast under the floor, with the end of the Y opening into the interior of the kiln. I followed the design of F. Lowell Baker, as shown in *The Art of Firing*.

To construct the blower, I attached the inlet of the vacuum cleaner motor to the 4' length of PVC pipe. To provide a variable air control on the amount of sawdust entering the blower, I constructed a simple inline air valve with the T-joint. I drilled 3 holes into the end cap, each ½" in diameter. A circle of plastic from a cottage cheese lid was also drilled with 3 holes in the same pattern. Using a sheet metal screw, I fastened the plastic circle to the top of the end cap. By turning the plastic circle to the left or right, I can open or close the 3 holes in the end cap, much like the top of a spice container. The



A one-inch layer of 2600° ceramic fiber.



The fiber is easily cut and shaped.



Steel protects the fiber and brick.

Photos : Pat Lindemann

T-joint apparatus was placed about 6" from the inlet of the vacuum cleaner motor. The other end of the 2" PVC pipe is placed into the sawdust hopper. The outlet of the vacuum cleaner motor was fitted with a metal muffler pipe, which was fed into the Y-channel of the floor of the kiln. The outlet was rectangular, so I had to make a trip to the metal shop in town and have them custom bend the end of the pipe to fit the outlet of the motor. Muffler pipe was chosen because of its ability to withstand heat.

When the vacuum cleaner motor is turned on, it feeds the sawdust from the hopper through the muffler pipe and into the cast tube in the floor of the kiln and up through the floor of the kiln.

STEP 15:
Install the Venturi Burner in Back Wall

I used a large venturi burner with a 750,000 BTU capacity to bring the kiln to red heat. After using the burner calculation information found at wardburnersystems.com, I knew I needed at least 500,000 BTU to fire this kiln. This burner was salvaged from a large tunnel kiln. The steel and fiber was cut away to expose the burner port. The burner was placed on a fire brick pad about 2" away from the opening to allow for plenty of secondary air.

STEP 16: Install the Sawdust Burner

The vacuum cleaner motor is placed on a cement block in front of the kiln. Place the metal muffler pipe into the floor channel and affix to the vacuum cleaner motor. Attach the PVC pipe to the intake of the motor, with the other end in the sawdust hopper.

STEP 17:
Fit Peephole Plugs and Thermocouple

I drilled out my peepholes, and thermocouple holes through the castable and through the fiber and steel. We used tin snips to cut holes in the steel.



Materials for feeding the sawdust.

Materials for Feeding Sawdust

- I vacuum cleaner motor-removed from vacuum
- I 4-foot length of 2" PVC pipe
- I PVC 2" T-joint
- I PVC 2" end cap
- 8 foot length of muffler pipe
- I bucket or box to serve as sawdust hopper
- I plastic container lid

10

KILN STORIES: LARGE WOOD-FIRED KILNS

The E.C.I. Express Train Kiln by Ted Neal

The plan and images included within represent a kiln built with students at Ball State University in Muncie, Indiana in the fall of 2007. All credit for the “train” kiln goes to John Neely who originated the design 20 years ago. The plan and images represent my version of the design with minor modifications to the structure to accommodate personal preferences and the needs of my students. The principle function of most of the elements within the kiln remains unchanged. Many articles have been published which discuss the basic design and function of the train or “coffin” kiln and its associated elevated Bourry box. (I will list some articles on the website *21stcenturykilns.com* for those interested in further investigation.)

Having built nine train kilns to date, I hope to add another resource and outline those things I enjoy about the design.

Note:

Plans drawn by Nick Swinehart and Ted Neal.

How the Train Kiln Works

Briefly, for those unfamiliar, the train kiln consists of a side-stoked downdraft Bourry box elevated just above the highest point of an elongated horizontal ware chamber.

The ware chamber empties into the flue via a checkered exit wall that it shares with the chimney. The firebox employs a stepped floor that ramps down toward the ware chamber with an air supply built into each step. This element is critical to the design, as it gives a great amount of control in efficiently dealing with the coal bed, allowing for selective opening to manage buildup. Raking coals becomes unnecessary.

The checkering of the primary and secondary air holes, into the firebox and coal bed respectively, allow for the precise management of a very responsive kiln. Depending on the length of the kiln, a number of stoke areas may be built into the side of the ware chamber to draw the heat and wood fired effects toward the back of the kiln.

Typical construction is a 9" wall with a hard-brick interior and IFB exterior with hard brick surrounding all service areas such as air, spy and stoke holes (with the exception of the chimney above the damper, which is a single layer of hard brick).

The unique position of the firebox in relation to the setting allows primary air to enter the firebox on top of the wood, which is then drawn downward through the fuel and into the ware chamber. Wood is held in position by hobs on the front and back wall of the firebox and one or two steel grate bars. This orientation is critical as it works with gravity and promotes a greater ash deposition.

Anagama-like effects are possible without the extended labor, lengthy firing, and mountains of wood normally associated with these firings. A typical firing in our kiln is just under 24 hours and consumes between one and two cords of wood. Peak temperature is easily reached within 12–18 hours. The remaining time is spent side-stoking and soaking, where the length of time held varies depending on the surface desired.

Earlier Versions

I was fortunate enough to be John Neely's student, as an undergraduate at Utah State University in the early 1990s, and was able to experience firing early versions of the kiln. The earliest that I remember had a shorter firebox, a low throat arch (the area between the firebox and ware chamber), and the flues holes were concentrated in a smaller portion of the exit wall. Subsequent versions employed a taller firebox, more open cast throat arch and an increased number of exit holes into the flue.

I went back to USU after graduate school as the studio technician and while there built two more trains. The last one I built while there is the predecessor of the kiln at Ball State. It was built using sprung arches over all interior spans with as much open space as possible in the throat and exit wall.



Ted Neal's Ball State train kiln

Kiln Design Factors

The choice of a kiln design should be based on many factors. Fuel (more specifically fuel availability), quantity and size of work being fired, surface desired, clay body and kiln location should be primary considerations. While no one kiln is perfect for all applications, the train was an easy choice for a number of reasons. First, our kiln pad is located in the center of campus with buildings, parking lots or homes on all sides. The design of the train is efficient and able to produce rich wood-fired surfaces with little smoke. Secondly, sensitivity and quick reaction of the kiln to adjustments allows students to rapidly grasp the principles of firing and, as such, it represents an excellent learning kiln. Lastly, I knew it would be easy to adjust

the size and features of the kiln to suit wood sources, existing kiln shelves, volume of student work, and my personal preferences.

Kiln Construction

Once the decision was made, the footprint was laid out based on the size of our existing kiln shelves and the volume of work that could be made by a small group of students over a short period (perhaps 100 pots). Two double stacks of 11" x 24" shelves occupy the middle and rear of the kiln and a single 11" x 24" stack fills the front behind the throat. An 8" side-stoke aisle was added between each of the settings. The side-stoke ports in the top of the chamber wall are two bricks high with a corresponding one brick high mouse hole at floor level. All other holes in the chamber walls shown in the drawings were added for viewing cones.

Hard Brick Sprung Arches

Wanting a kiln with longevity and low maintenance and knowing it would probably average fewer than 10 firings a year, I decided to build hard brick sprung arches over all spans including the main chamber, throat, firebox, loading and stoking doors. I believe this to be a very durable solution, although there are many other working options. I have seen many resolutions for spanning the chamber used successfully including: kiln shelves covered with layers of insulating brick, coated fiber, castable on a rolling system (sarcophagus style), a hinged sprung arch (think coffin), and even some hybrids with part sprung arch and part hinged lid. The beauty of the train is this adaptability. Low or high tech, it delivers just the same.

The addition of a fixed arch over the main chamber necessitated the use of a side load configuration. Although this is not as comfortable as standing, as was possible with other versions of the kiln, I find it to be an acceptable trade-off. Regardless, loading is generally completed in a couple hours and bricking up the small door takes less than 5 minutes.

The fixed arches have also provided benefits to the function of the kiln. First, the entire throat area, with the exception of about six inches where the throat and main arch overlap, is open for flame movement. Additionally, the fixed arch allows for the opening of holes into the flue in the uppermost areas of the back chamber wall. The net effect of both of these factors has been the elimination of almost all shadowing effects from the kiln itself. We have been able to achieve excellent results and have reached cone 10 in all areas of the kiln. (The area behind the throat just prior to the ware chamber had been dubbed "the triangle of death" in other designs due to this shadowing effect).

Placement of the Loading Door

Since the loading door consumes a lot of space on the front of the chamber and the kiln had a lot of room surrounding it, I moved the side-stoking operations to the rear of the kiln. I suppose the ideal side-stoking setup would be from both sides of the kiln, giving stokers more options (something I may try to incorporate on future builds). However, I like this configuration, as we are able to have distinct wood areas for each side of the kiln. The firing proceeds at a leisurely pace, even at peak temperature. Those who have experience firing the train will

tell you, like any wood kiln that has a good firebox and tall stack, there is a lot of “holding it back.”

Firing the Kiln

The firing itself is not unlike other wood kilns. We begin the firing in the early evening with a small fire in the lower stoke/ash pit door. The kiln begins to pull immediately. With one or two of the secondary air holes open, the fire is maintained in this space for the first six hours as we target a climb of about a hundred degrees per hour. When we reach 700°F we begin stoking in the firebox. A few narrow strips are tipped down into the firebox from above to start the wood on the hobs/grates quickly and to avoid smoldering. At this point one or two of the primary air holes are opened. Depending on the type of work in the kiln, we continue to proceed slowly through 1200°F and then quicken the pace until we hit body-reduction temperature. After a short period of reduction we resume normal stoking until 1900°F is reached.

Side stoking then begins and small kindling wood is bundled and slowly pushed into the side openings, hanging into the kiln until it has burned away. After a few minutes the process is repeated. It is not necessary to do this continually, but only as needed to reach the desired temperature. Coals are maintained here with the mouseholes. We alternate stoking between the side and firebox until cone 9 is reached. The kiln is held at this temperature for several hours to develop the surface and even out the temperature until the top cones fall. The firing is completed with a gentle stoke of large pieces of wood in the main firebox while the dampers

are eased in over a 15-minute period. The passives are then pulled above the damper to spoil draft in the flue.

Very little of the primary air is ever opened during the firing of this kiln. Even at peak temperature only two or three of these holes are open. This setting, combined with a full firebox, establishes a very long flame in the kiln. Opening more than is needed produces a short flame that exacerbates any temperature differences from front to back. The damper, in this kiln specifically, is left open about 75% through the entire firing. The split damper has proven useful in encouraging the flame to move to the left or right of the kiln. I have found that if I close the damper slightly more on the stoking side, it helps to move the flame and equalize the temperature on the opposite side.

Reduction Cooling

Reduction cooling is another possibility. Here, the kiln is shut and sealed with the exception of one damper (open a fraction of an inch) and one of the high secondary air holes. Very small pieces of kindling wood are added in the firebox to maintain a small “lick” of flame around the damper as the kiln cools. When the flame retracts from view another stick is added. This is maintained until the kiln cools to 1450°F. The cooling process adds several hours to the firing. (The last one hundred degrees can be a killer.) This has the effect of preventing re-oxidation in the cooling cycle until the oxides, primarily iron, can no longer change state, promoting the development of beautiful dark tones and varied surfaces on the clay bodies.

Budget and Materials

The entire kiln was built on a small budget. All of the hard brick came from a steel mill that shut down in Utah. So the main cost was the shipping of these bricks and the purchase of some insulating brick seconds. I was able to get two tons of “used” (really, very new) ten-foot pieces of angle iron and channel donated from a local scrap yard. There are great stories associated with both of these acquisitions, but for brevity, “the right place at the right time” will do. All total, the kiln cost us less than three thousand dollars. It has been my privilege to fire a lot of great kilns in the last 15 years including: anagama, noborigama, catenary and Bourry box kilns. Each has provided wonderful and unique surfaces in addition to great experiences and memories. I will add another to the list as this kiln has produced exceptionally good results, is easy to fire and has become an integral part of our program.

Note: After discussion with John Neely, I believe the following should be noted. The process of firing a Bourry box is different in several ways, and understanding these fundamental differences will make firings proceed smoothly.

First, it is imperative that the firebox reach temperature significant enough to ignite the fuel prior to stoking on the hobs.

Second, opening more secondary air than is needed during the firing will promote back burning. These spaces should only be used to burn down coals as they block the openings. Once coals have burned down these should be closed. (Otherwise they may act as the primary air and the top of the firebox would then become the chimney — back burning).

Lastly, stirring or shaking the wood is not needed in the train and may drop wood into the coal bed before it has sufficiently turned to charcoal. If you are interested in building and firing this kiln, my strongest recommendation would be to participate in one firing with someone who knows the kiln.

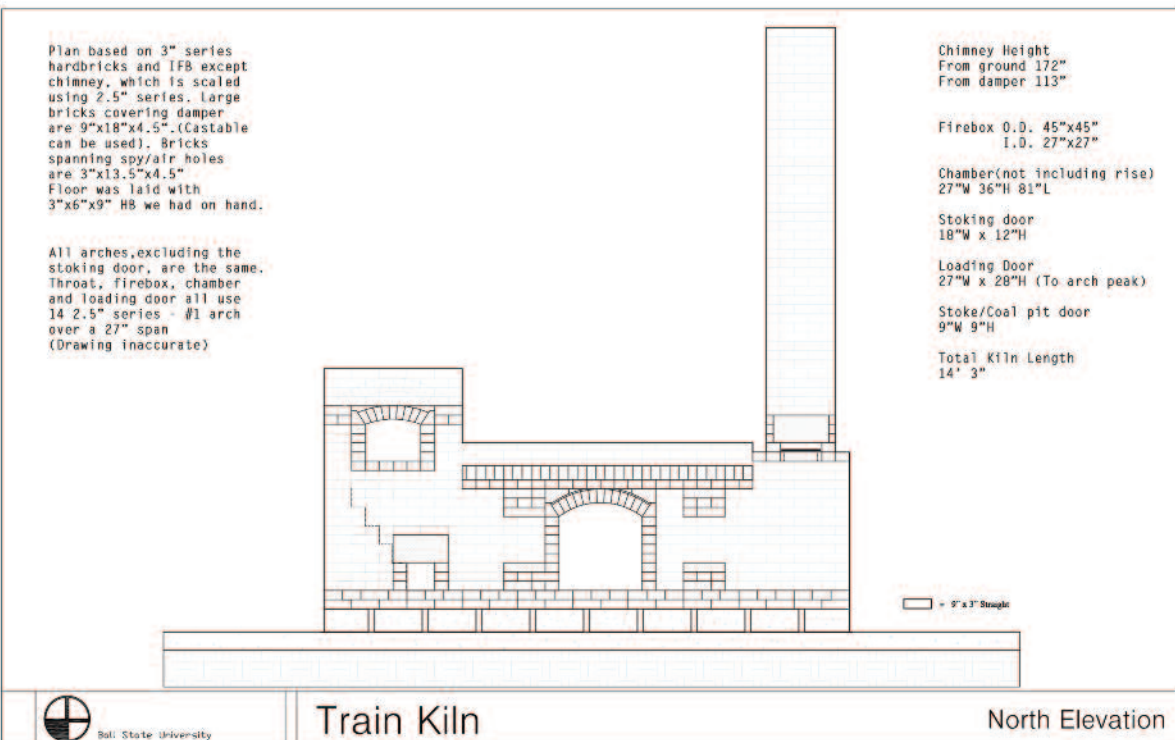
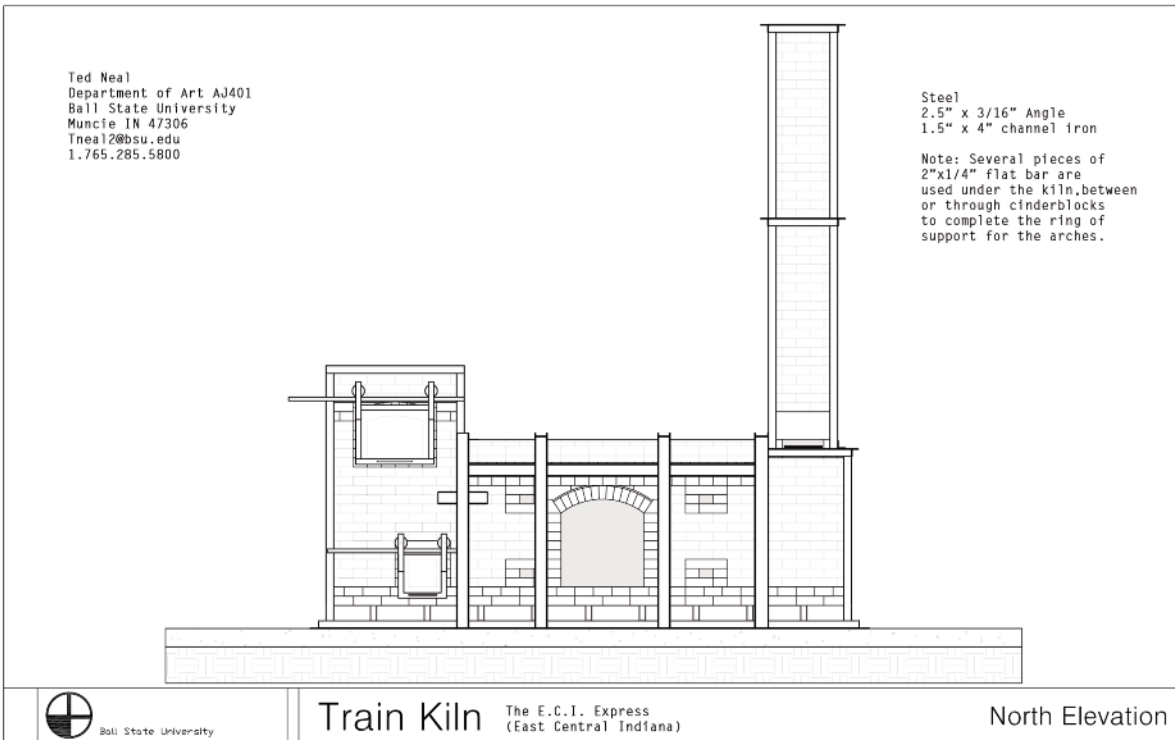

Plans drawn by Nick Swinehart and Ted Neal

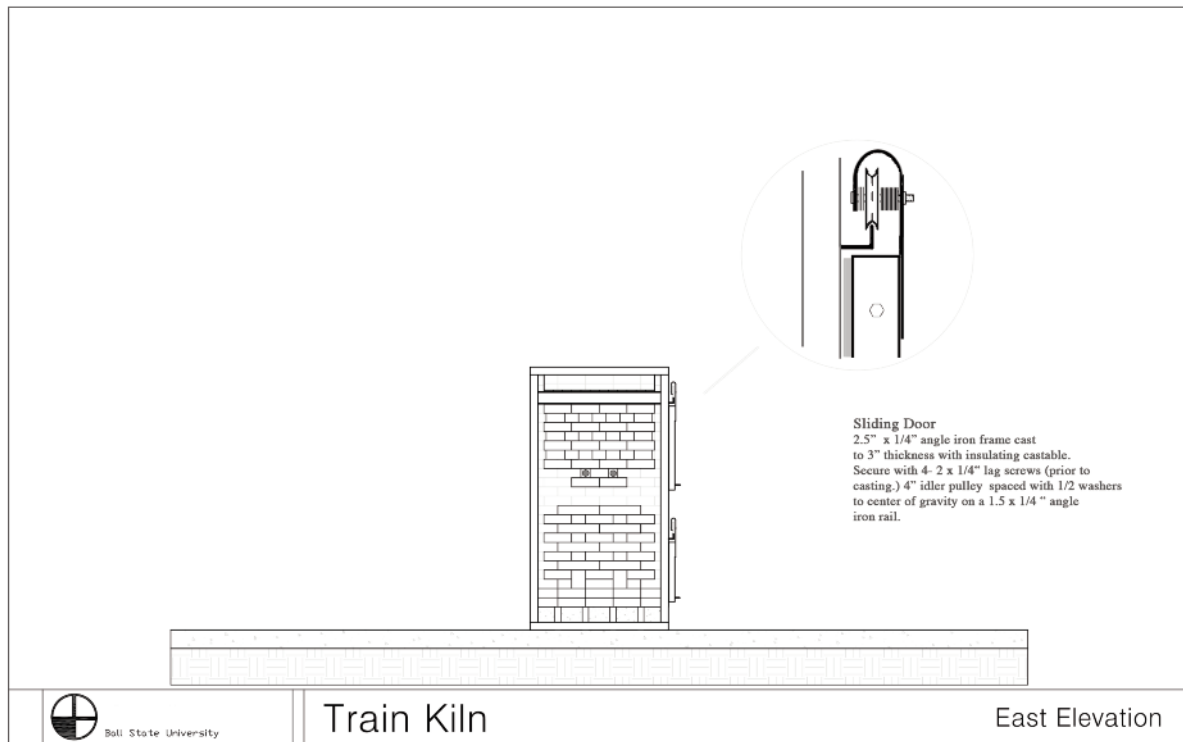
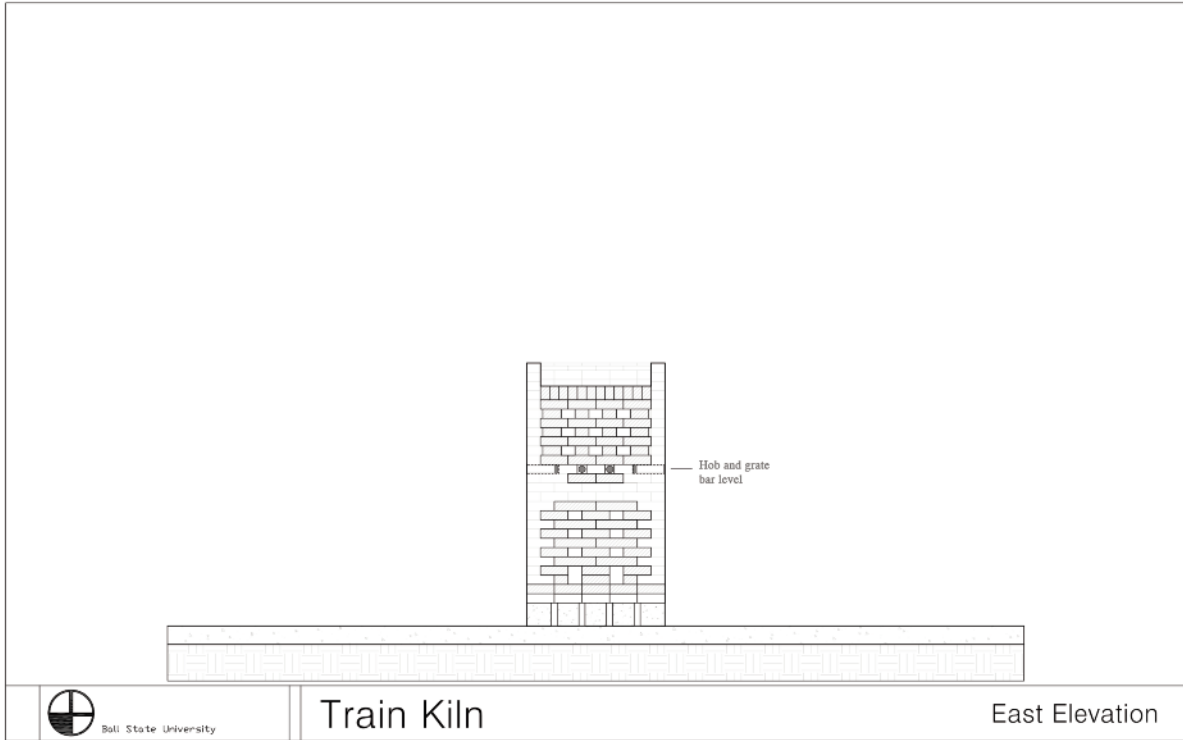

Plans drawn by Nick Swinehart and Ted Neal

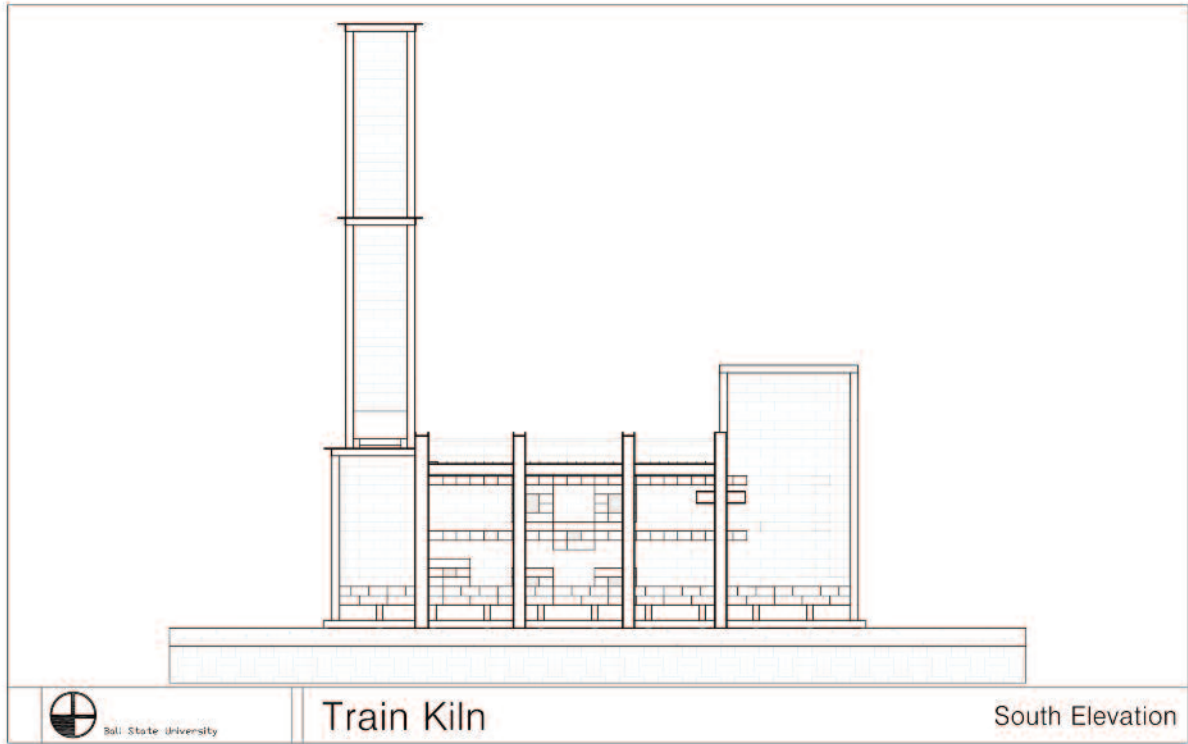
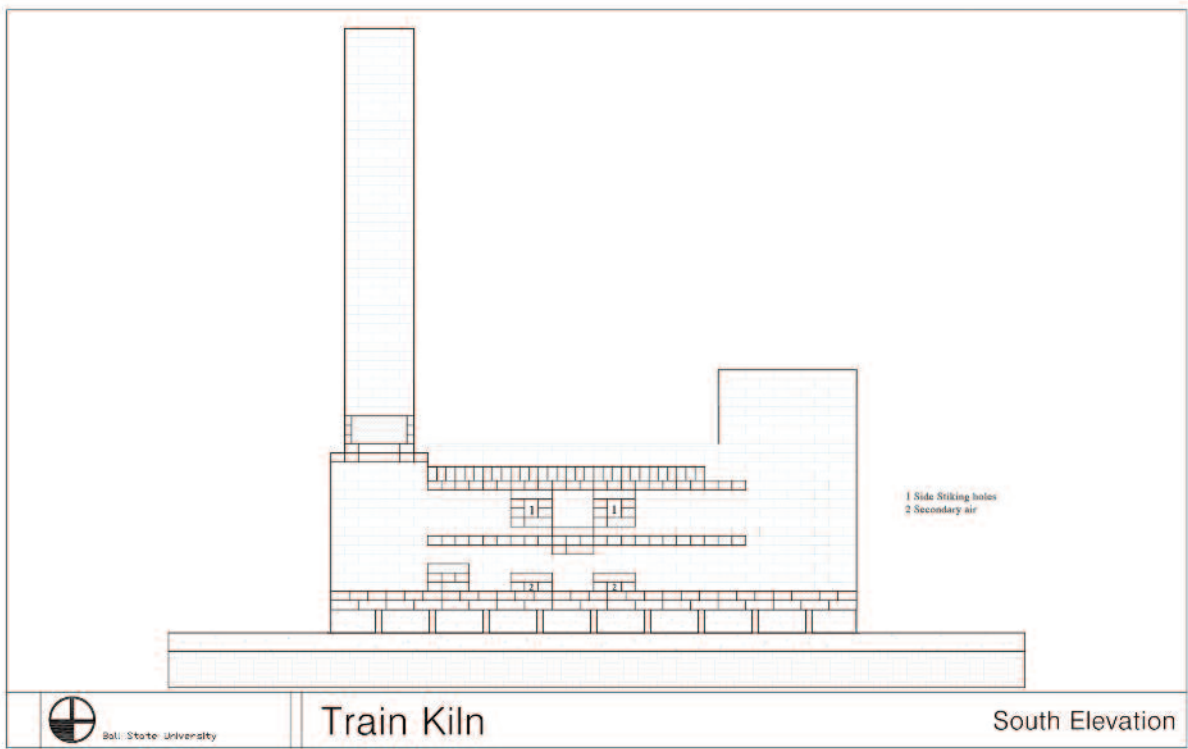

Plans drawn by Nick Swinehart and Ted Neal

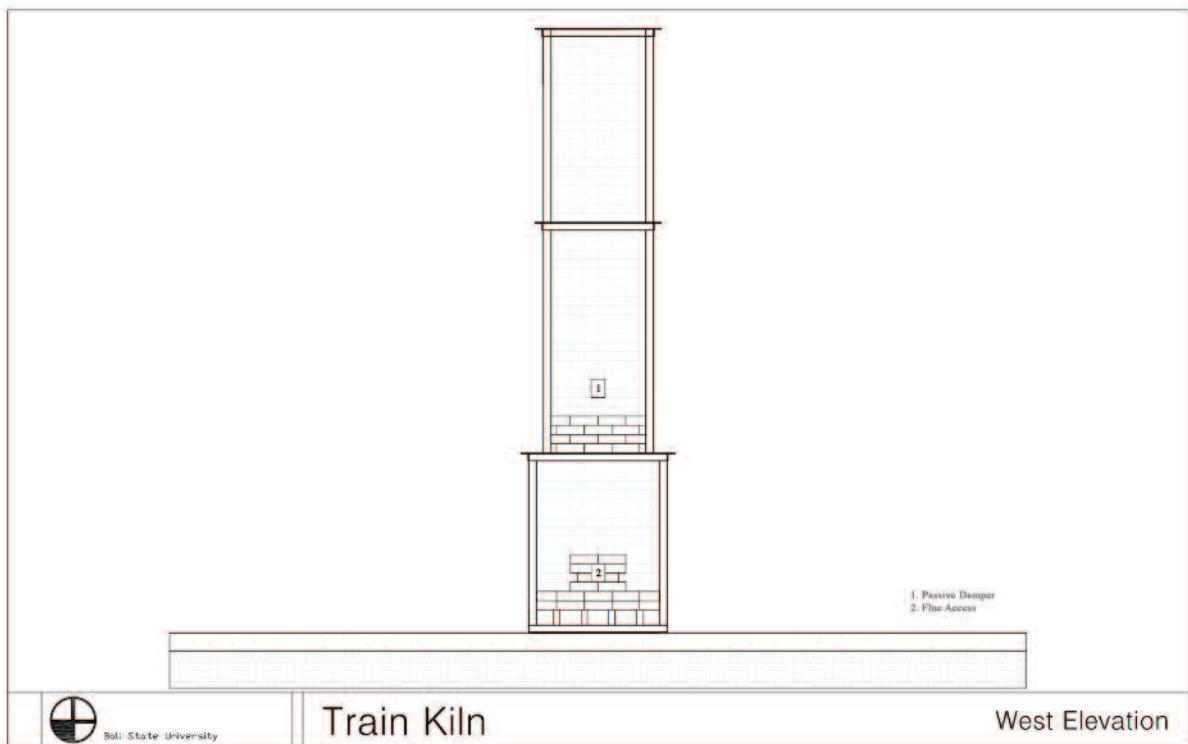
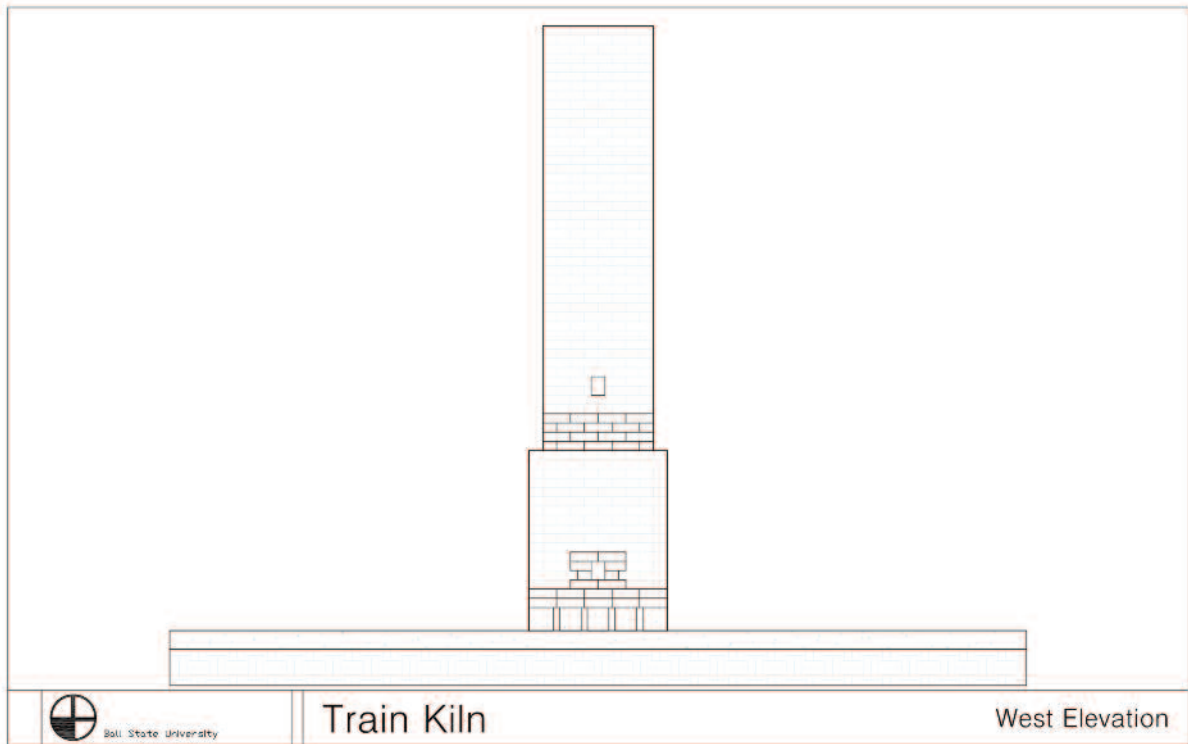

Plans drawn by Nick Swinehart and Ted Neal

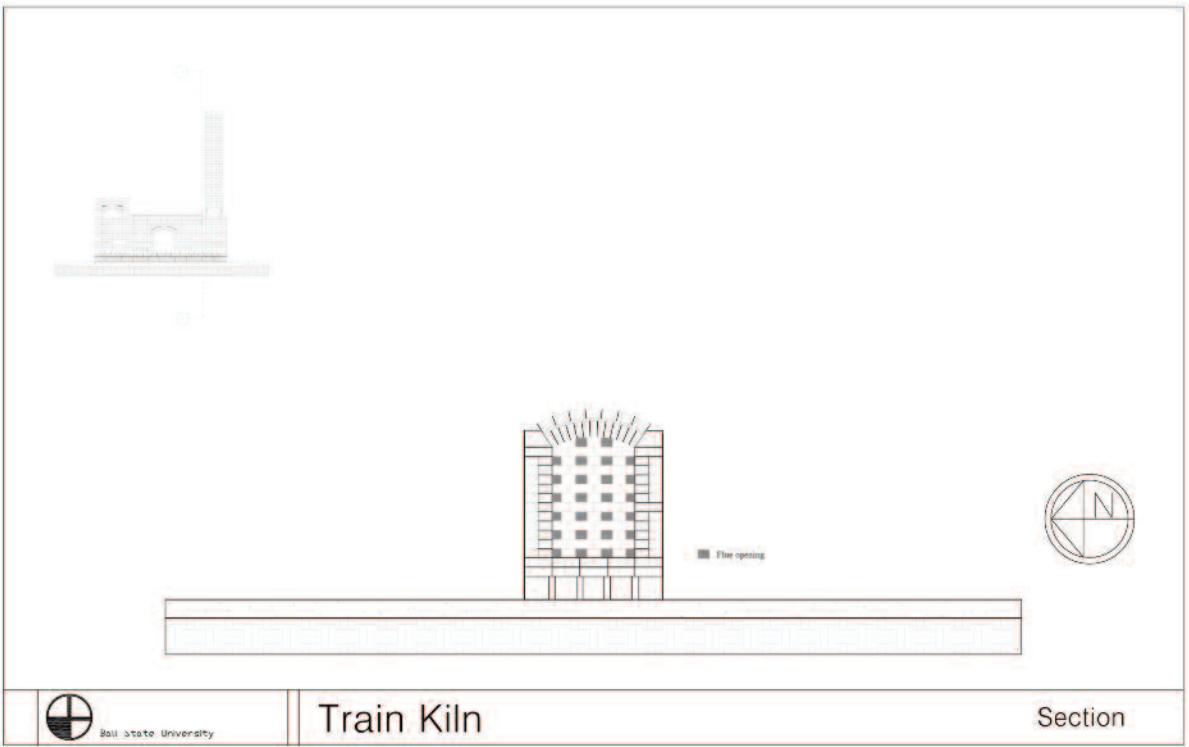
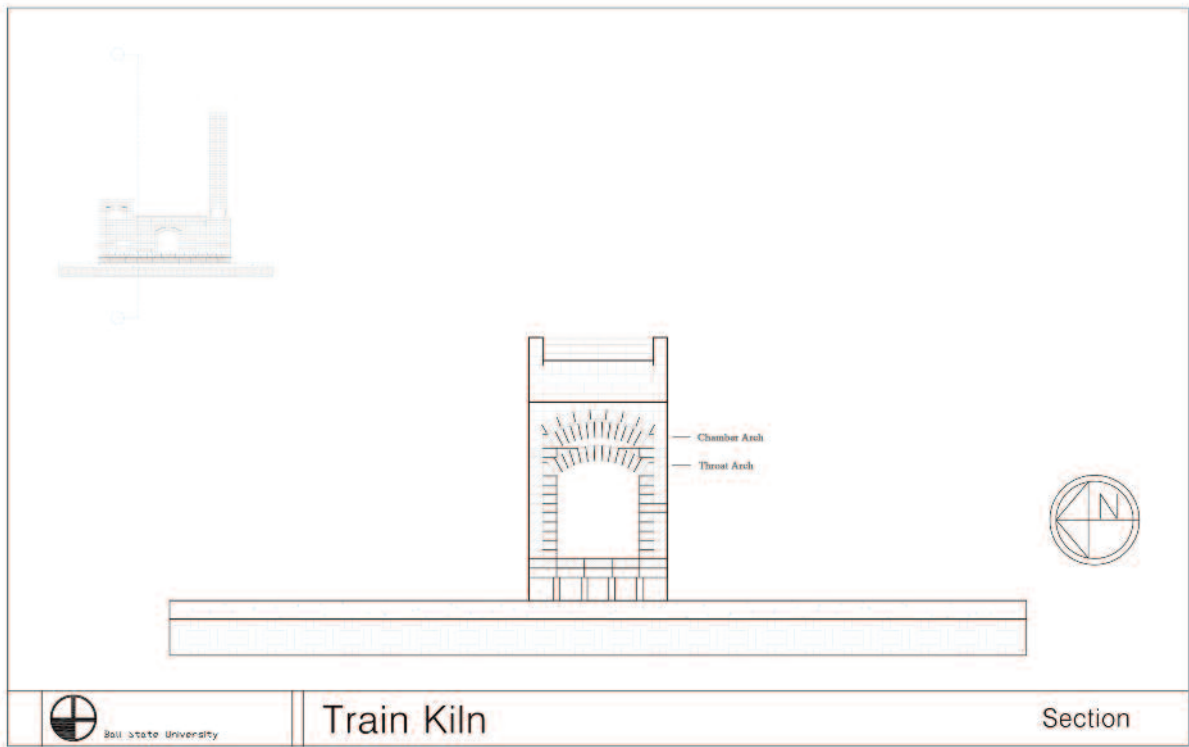

Plans drawn by Nick Swinehart and Ted Neal

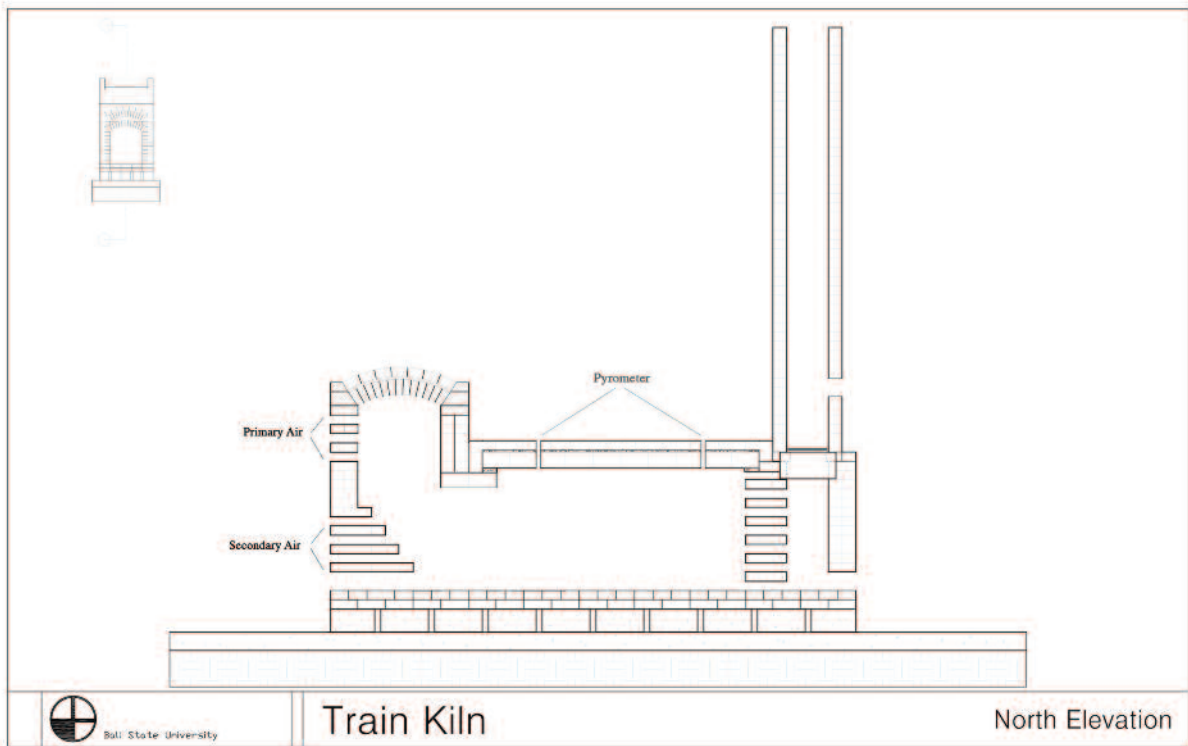
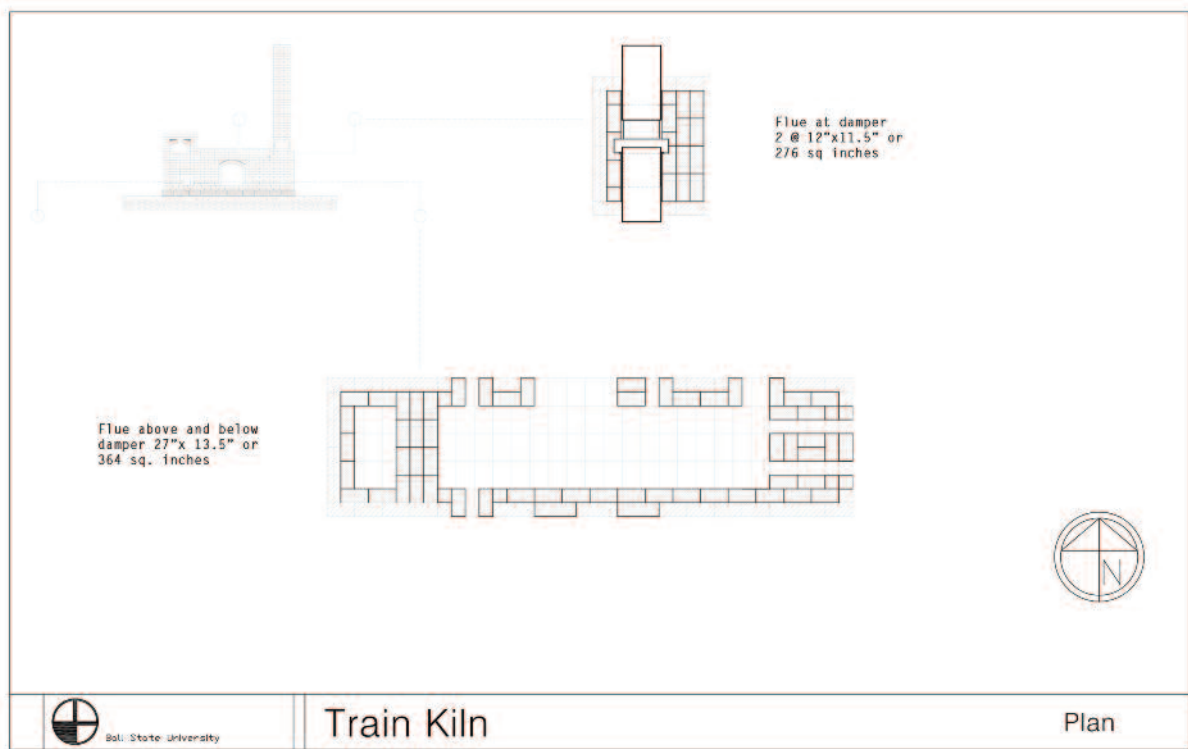

Plans drawn by Nick Swinehart and Ted Neal

Hay Creek Wood-Fired Kiln A Donovan Palmquist Design by Mel Jacobson

We had a small wood-fired kiln at the farm, but we never got it to work right. One day, Colleen Riley inquired about using the farm as a test bed for a new wood-fired kiln idea that her husband, Donovan Palmquist, had. Remember, Donovan is the best kiln builder in America. Colleen is a long time Hay Creek gal, and almost a daughter to Mel. Would we say no? Hell NO! We had tons of bricks, good tools and an eager group of potters to help and do the grunt work. We saved the project for our two-week camp.

As a great help, Smith-Sharpe Fire Brick Supply donated many bags of outdated castable material. It was old, but Donovan thought for sure it would still be good as it had been well warehoused.

The Plan

Donovan's plan was to build a fairly big flat-bottomed kiln in the shape of a curve/whale/fish. His thought was to build the sidewalls and fill it with sand—wet sand. This would form the arch for the main body of the kiln. We have lots of sand at the farm and a great John Deere tractor with a bucket. That made it easy to fill the kiln.

The slab was in place, so he traced the kiln with chalk on the slab. It fit like a dream. The firebox would be built with a standard arch, and the grates would be a hard brick network.

The Base and Floor

The project began with Donovan directing folks to get brick and stack it for him. The concrete block base would be kept low, one level, with an expanded metal base on the block. Then the



The kiln floor.



This is the basic layout of the kiln.

entire floor was built. Several layers of hard and scrap IFB made up the floor. Everything was done to perfection.

The Sidewalls and Arch

The sidewalls of the kiln were built with a large belly in the center. It started to take shape. The firebox went in and the arch form began to take shape. Donovan had his brick saw with him and it was really fun to watch the pieces go together with ease. A master kiln builder is a wonderful thing to watch.

The Brick and Castable Roof

When the walls were all done, made of hard brick all the way, it was time to load in the sand. We dumped load after load with the tractor and filled the cavity to a big mound. We dampened the sand and Donovan sculpted the shape that he wanted. Then the hard bricks were laid in an arch over the sand. He did only one layer as that is all that was needed to bridge the arch. He packed the arch very tight.

The next step was to mix the castable cover. We used an old cement mixer. The castable comes with a bag of stainless steel pins that are added to give strength to the castable. Some potters don't add them, but we do. Groups of people with good gloves slammed the castable into the arch with a great deal of force. We just threw it down hard. It seeped into all the cracks and formed mini key-bricks in the arch. It was a long day mixing and slamming, and then Donovan troweled the entire first layer into a neat form.

We covered the castable with plastic tarps to slow the drying time. The next morning we added a second layer of castable. It was now nearing 6" thick. Donovan did a great deal of trowel work and the shape really started to emerge. It was again covered and left overnight to set up.

The third day we added another very thick layer of castable to finish the kiln body. It was now 9" thick. Donovan fussed over the trowel work and that phase was done.

The Chimney and Shelter

The final step was to build the chimney with mortared hard brick. We used mostly new brick for this stage. A high quality commercial



photo : Andy Kazukewicz

The sand is being loaded in; the arch is on the firebox. The first layer of brick for the body of the kiln is going in with sand as support.



photo : Andy Kazukewicz

Completing the main body of the kiln.



photo : Andy Kazukewicz

Donovan puts the first coat of castable in place.



photo : Andy Kazukewicz

The kiln is almost done. Three coats of castable. The stack is done.

mortar was used and a great deal of time was spent with a large level and string line. It was straight, plumb and true. Even as Donovan was doing the chimney, Tim Frederick was building the roof and cover structure. The major part of the kiln is protected from the weather, rain and heavy snow. It is easy to measure and cut around the chimney when the roof is added. We left at least a 6" gap between the stack and the metal corrugated roof.

Removing the Sand and Adding Bracing

A group of people armed with shovels and buckets unloaded the sand from inside the kiln. That was the most daunting of jobs, but it went well, and all took turns. Much of the sand was placed around the kiln, almost as a buttress. A few angle iron braces were added, especially around the firebox.

The Door

Donovan built a hanging, swinging door for loading wood. It can be pulled aside and hung out of the way during stoking.

The door/wood-loading area and oxygen vents are free stacked for each firing.



photo : Andy Kazukewicz

Inside the new kiln.

A Few Extras

We also cut long pieces of scrap carpet to be used on the floor of the kiln as we load. The carpet is pulled back as we load, and that makes it very easy on the legs when loading. We roll the carpet when finished and have it ready for the unloading. That is really important, as the floor of the kiln stays hot for days. The carpet again protects the body from heat and scale and hard things that bite.

We also added a good electrical system around the kilns and have a bright trouble light in the kiln for loading pots.

We used many older odd-shaped kiln shelves to load the kiln. Some of the pots are free stacked, but our folks love glaze, so many kiln shelves are used during the firing.

Firing the Kiln

The kiln is based on a very flat configuration. The firebox, the floor of the kiln and the base of the chimney are at the same level. The heat and flame path seems to just blow into the kiln and keep on going. The cones seem to drop all together. Our biggest concern is keeping a steady



photo :Andy Kazukewicz

The kiln cover going up. Note the old cement mixer we used to mix the castable.

stoking pattern and never letting the kiln run away. When a wood-fired kiln has perfect balance it will fire very fast. In fact, we are sure that, using very dry wood and small quick stokes, we could fire this kiln to cone 11 in just 15 hours. In fact, on the maiden firing it just went far too fast. And that was four days after building it.

Donovan added about four more feet to the stack this last summer and it sure helps control the firing. It has a full damper in the stack and a passive damper system. We just pull a brick out of the stack to slow things down. Our last firing went for about 25 hours.

This kiln is perfect for the 15 potters of Hay Creek Camp. We have been totally delighted with the results.

The Wood Supply

We have a great big supply of pine slab lumber from a local saw mill, and Kurt Wild has acquired a supply of walnut and cherry sticks from a local factory that makes trophies. Most of the sticks are 1- or 2-inch squares and are about 12' long. We have made a chain saw



photo :Andy Kazukewicz

The wood kiln ready for loading. Note the stacked wood, all cut and split and under the cover.

frame that holds a bundle of the sticks or slabs, and we just cut them into 20" pieces. It makes a perfect handful to throw in. Our goal is to never strangle the kiln. We stoke, wait, see smoke; then it clears and we stoke again.

This is an ideal situation as we break the potters into teams of four, taking shifts of four hours each so no one gets totally tired. We are very careful to avoid liquor and silly behavior around our kilns. This is serious business, and "party time" is very dangerous.

We cut and stack wood all during the firing, and then stack at the end so that we have enough stored for our next firing. We never want a shortage of wood.

Gas Burners—It's Not Cheating!

The kiln has two ports for gas burner insertion. If we should have rain, a storm or any other unexpected problem, we can just turn on the gas and let her rip. It gains temperature with gas very nicely. It is also prudent to use gas at the lower level of the firebox from time to time to burn up all the ash and unburned slag. This clears the kiln and makes it ready for wood

again. We find that using gas as an aid is not “cheating.” We are committed to using any system that aids the firing. We are about good systems and engineering, not hocus-pocus. Our people want great pots, and what the fire is made from does not matter. Gas is the great protector for our wood kiln. We refuse to waste a firing if bad weather hits us, or if there is a problem. Gas allows us the time to correct, wait out a problem, or just plain rest.

Building and firing a major sized wood-fired kiln is a big commitment. It is not an easy or cheap way to go. If this kiln were built for any university it would be a huge expense—thousands of dollars. We had the bricks and a wonderful

source of donated castable. It all came together because of a very dedicated master kiln builder. He learned a great deal and has a workable plan that he can sell, and we, with the help of a great team, have a magnificent kiln. We call this experience “adult shared learning.” It involves men and women, old and young, experienced potters and beginners, each lending a hand and having equal input to the process. It is the way great learning happens.

*Mel Jacobson can be reached at:
21stcenturykilns.com*

*Donovan Palmquist can be reached at:
kilnbuilders.com*

11

KILN STORIES: A GAS/ELECTRIC KILN

To get a reducing atmosphere in an electric kiln, one must add some type of reducing agent, such as gas. However, this can cause problems for the kiln's heating elements.

Normally, electric kilns are fired in a neutral or oxidizing atmosphere, and the elements develop a somewhat protective coating of oxidized alumina.

During reduction, this coating reverts to the metal and the elements can get smaller, and layers of the element can even spall.

While elements can be reoxidized in subsequent firings, both their efficiency and life expectancy are greatly reduced.

To preserve metal elements, they need to be protected from the kiln atmosphere, and ITC (International Technical Ceramics, Inc.) produces a nonconductive coating that does just that.

Here is a hands-on demonstration that follows the Nils Lou method for creating one of these small gas/electric hybrid kilns.

Caution: This kiln must be well ventilated!

Materials

- Kiln—new or good used one (*Note: If your kiln is under warranty, this procedure may void it. Contact the manufacturer to check the details for your kiln.*)
- New electric elements
(We ordered ours from Euclid's.)
- Bleach (household)
- ITC 213 Ceramic Coating for Metals
- ITC 100 Ceramic Coating
- ITC 296A Ceramic Top Coating
- Bunsen burner (Frey Scientific)
- Propane hose and fittings
- 25 lb propane cylinder
(like the kind used for a barbecue)

Tools

- 5-gallon bucket
- Glaze mixer • Blender
- 1/4-inch hole saw/drill bit
- Compressor capable of 90 psi
- Sandblasting gun and hose



STEP 1 Take an electric kiln completely apart, and remove all elements, wires and switches. Drill a 1/4-inch hole in the center of the top and bottom (not shown).



STEP 2 Thoroughly clean the kiln. While a vacuum cleaner works, using compressed air does a great job, but because of the dust, work outside and wear a mask.



STEP 3 New elements have a thin manufacturing film on them so clean them well in household bleach using a small brush. Rinse them well and hang to dry.



STEP 4 Mix 3 parts of ITC 213 with 1 part water in a blender. Estimate what you need, and make more if necessary or store excess in an airtight container.



STEP 5 Thoroughly coat the coils by dipping them. Use a sheetrock mud pan or a 5-gallon bucket. Hang the coils up to dry.



STEP 6 Lightly spray the inside of the kiln with water. This allows the ITC to form a more even coating.

photos : Pottery Making Illustrated magazine



STEP 7 Add 2 parts of ITC 100 to 1 part water and mix thoroughly with a power mixer. The ITC settles fast so you will have to keep agitating (stirring the bucket) as you work. It helps to have two people.



STEP 8 Using 90 lbs. of pressure in the air compressor and a sandblaster/spray gun, spray the kiln with an even coat of about $\frac{1}{32}$ to $\frac{1}{16}$ inch thick.



STEP 9 After the ITC dries, install the coils; use original instructions that came with the kiln.



STEP 10 Reinstall and check all Kiln Sitter parts. Reconnect all wires after you make sure all fittings are tight and clean and the connections have been sandpapered. Note the overspray that came out of the peep holes. This does no harm, but you can clean it off if you wish.

photos : Pottery Making Illustrated magazine



STEP 11 Now spray the entire interior—coils and all—with a second coat of ITC 100. Make sure it is all well covered.

OPTIONAL To obtain a higher degree of purity when firing porcelain, jewelry and other fine items, spray the entire kiln with a coat of ITC 296A Top Coat. To 2 parts of ITC 296A, add 1 part water and mix well.
Note: ITC 296A is applied **after** ITC 100 has been applied and fired.

CAUTION

To avoid having the reducing atmosphere leaking out of the kiln and harming electrical components, make sure you plug (with ITC) the holes where your element wires go to the outside of the kiln. Allow the kiln to dry, then fire it to cone 08 or so.



STEP 12

Buy a nice high-heat Bunsen burner (propane). We used one from Frey Scientific.



STEP 13

Connect the hose to a 25-pound propane cylinder with a regulator. Fittings are available from gas suppliers. Place a piece of Kaowool over the hose under the kiln so it won't be affected by the heat.



STEP 14

Load the kiln. To enhance air flow, and to promote even reduction, use half shelves and stagger them. Full shelves will simply divert the flame to the outside edge of the kiln

photos : Pottery Making Illustrated magazine

FIRING INSTRUCTIONS

1. Fire with electricity only until you reach 1750°F.
2. Leaving the electricity on, turn on the gas, light and place Bunsen burner under kiln so that the flame goes up the hole in the bottom. Make sure you have proper ventilation.
3. Adjust the reducing atmosphere by partially covering the hole in the lid with a piece of kiln shelf. Move it until you get an inch or more flame from the spy hole on the side of the kiln.
4. Fire until Kiln Sitter trips and/or witness cones fall.
5. Turn off the gas and electricity. Plug holes in top and bottom of kiln with Kaowool plugs.
6. Optional: If firing a lot of copper reds, soak the kiln (when the kiln cools to 1750°F) by turning the gas back on for about an hour.
7. Allow kiln to cool completely (well, 250°F anyway) before opening.

WARNING: This kiln must be well ventilated!

TIPS

Use a decent used kiln, not a beater. You want a clean, tight soft brick surface. Never coat old elements with ITC. It will not work. Always buy new elements. If the lid doesn't fit tight, make a gasket from thin sheets of Kaowool. Kiln shelves may also be coated with ITC 100 to improve resistance to deflection.



photo : Pottery Making Illustrated magazine

12

FIRING SAFETY TIPS FOR GAS KILNS

Plan for Firing Safety

The best way to make safety a standard practice is to have a written procedure that you can follow every time you fire your kiln.

A great metaphor is that firing a kiln is like flying an airplane. You, the pilot, need a safety checklist that you run through each and every time you fire. You do not “fly” until everything on your list has been checked off.

We have provided a basic checklist for you here—but you will certainly have items of your own to add to it.

Kiln fear is a real thing. Many people become skittish around gas burners and hot kilns. But the more you practice safety the more confident you will become.

How many minutes in your life do you need a seat belt in your car? About 10 seconds, but if you don't have it buckled, you are hurt or dead. The same concept is in play for your kiln.

Before Starting

Know How to Shut Off the Gas

Always know where the main gas shutoff valve is. Practice shutting things down in an emergency, and have family members versed in turning things off. You may only need your main valve shutoff once in your life, but that will be the day you save your studio and home from fire.

If you have a major gas leak, it is always safest to shut off all the gas to your kiln and home right at the meter. You may have a metal tag through the shutoff valve. Remove that, and just turn the main valve off with a wrench.

Post a sign with shutoff instructions near your kiln. This sign should also include your fire number or address, and the location of the nearest fire hydrant.

Plan and practice a fire drill. Know exactly what you will do if you have a gas leak or a fire.

Checklist for Firing

Before Starting

- Post a sign with gas shutoff instructions, fire number/address, and location of fire hydrant.
- Clear all debris and items you can trip over away from the kiln site.
- Check weather and wind direction. Rain and low barometric pressure can make the kiln harder to control. Heavy wind will also affect firing. If bad weather is expected, hold off firing to another day.
- Gather personal safety gear:
 - Welding or other heat-protected gloves Heavy-duty boots
 - Welding goggles (to view inside the kiln during maximum heat)
- Gather fire safety gear. (This is to protect wooden or flammable structures near your kiln. You DO NOT spray a hot kiln, EVER.)
 - Fire extinguisher and garden hose
 - Simple garden sprayer filled with water, and on the mist setting. This tool is wonderful to cool walls or beams in your ceiling during a firing.
 - Have your fire number at hand and a phone for 911. If firefighters do come, let them know they cannot spray water on a hot kiln. It will explode.
- Make sure you have another person around who knows you are firing your kiln. That person must know where the gas valve is for shutting off the kiln.
- Remove all children and pets from the kiln site.

At Start-Up

- Check thermocouples and pilot lights.
- Remove the damper. Pre-heat the stack with a BernzOmatic type torch before lighting the burners.
- Turn on gas. There should be no gas smell or hissing. Check gauges if you have them.

During Firing

- First hour is most critical. Check that pilots have clean blue flame and damper is properly set.
- Check that you have proper air movement around the kiln. Check for excess heat.
- Have an oven timer or alarm clock to set as a reminder of kiln firing tasks.
- Check the firing, then step away. Do not stay in the room with the kiln.
- Remain sober! This is not a party. Do not leave your kiln untended.

Be on Constant Lookout for Danger Signs

- Headache, dizziness or nausea is a sign of carbon monoxide poisoning.
- Smell of gas or smell of burning wood are signs of danger.
- Strange noises from burner, like screaming sound may mean gas is burning at the orifice. This will cause the burner to get red hot. Turn off burner and start over.

Clean Your Kiln Site

Keeping your kiln site clean and tidy seems to be logical. We have all seen those kilns with broken brick all over the ground, shelves scattered around, and broken pots on the ground under the feet of those firing. This is a recipe for disaster.

Clean your kiln site before you ignite the kiln. Make all walk paths and areas around the kiln free of debris. If you have to make a dash to your burners, you should not be tripping on old broken pots and bricks.

The very concept of being a craftsperson should dictate the same sense of order and care around your kiln as you do when you make quality clay work. “Craftsmanship” means all phases of the work, from the clay to the fire.

Consider Variables like Weather

I remember writing a section for Nils Lou’s book *The Art of Firing*. I wanted to illustrate to people that there is no simple answer to firing. The variables are just too many. For example:

June 16th, at the farm, the sky is clear, hot sun about 88°F, barometer is high. Perfect conditions to fire a kiln. Wind out of the south at 8 miles per hour. Happy potters. Six months later, at the farm, -16°F and a wind and snow squall from the north at 20–30 miles per hour and you have to fire the kiln. Barometer is dropping like a brick in a pond. Notice any difference? Oh, and that propane tank is frozen. Another problem to solve.

Burning incense and chanting will not help the firing. In fact, you may have to shut it all down and wait for a better day. Rain and low barometric pressure can make the kiln harder to

control. Heavy wind will also affect firing. If bad weather is expected, hold off firing to another day. You cannot take out your notebook from June and fire the same way every time.

Gather Personal Safety Gear

Owning a variety of gloves is helpful when firing. The gloves that baseball players wear are nice for loading kilns. They will have that good feel, but save your hands on sharp edges of kiln shelves and furniture. Always keep several pair of welder’s gloves on hand and use them when the kiln gets hot. Heavy-duty boots will protect your feet.

The glass that goes into an arc welder’s helmet works very well for peering into bright kilns. It is far superior to sunglasses. Always have a few of those glass pieces for visitors to use when looking into your kiln. They cost just a few dollars and may save your eyes looking into hot kilns.

Check that Fire Safety Gear Is Ready

Even though you have built your kiln and structure with safety in mind, you should still be prepared for fire. Keep a garden hose and extinguisher handy. **Remember that you should never spray water on a hot kiln. It will explode.**

Use your garden sprayer on mist setting to cool walls or beams in your ceiling during a firing.

Review the steps you would take if there were a fire or other accident.

Plan to Concentrate on Firing

Plan firing times so you will be without interruption, but make sure you have another person around who knows you are firing your kiln and

can check up on you. That person must know where the gas valve is for shutting off the kiln.

Clear all children and pets from the kiln site.

BASOs, Thermocouples, Pilots, and Burners Must Be Well-Maintained

Always use BASO valves that are activated with a good strong pilot light. Keep your thermocouples clean and in good shape.

Periodically test your system to make sure it's working correctly. With your burners on, blow out the pilot lights. Look to see that the BASO valve shuts down the fuel to the burners. This is a small test that will keep your kiln from giving you dangerous problems. If the kiln does not shut down, the first thing to check is for a bad thermocouple. Keep several in your kiln area for quick replacement. They are very inexpensive and easy to change. A good BASO valve will last a long time.

If possible, have more than one shut down valve. Paint them red for greater visibility.

Cleaning Tips

With all burners, simple cleaning and maintenance is critical. Keep a small wire that is the same size as your orifice to clean them out every few months. There is a moth that loves the smell of gas, and will nest inside burner orifices. A hornet that loves clay will pack clay inside your hoses and burners. If you ever experience a lack of gas pressure for your kiln, check for a moth nest in your burner.

Periodically Replace Hoses and Connections

Replace all hoses and burner connections every five years. Double-check hoses for small breaks or leaks. Check all pipe thread connections

every spring. Make sure everything is tight and not contaminated with grease or dirt. A thick bubble solution of dishwashing soap and water and a big watercolor mop brush slobbered on all connections will help you see bubbles that show your connection is leaking or loose. In that case, shut down the gas and tighten or replace the connection. You cannot be too careful with gas connections.

Just like a sharp knife is the safest kind, a clean, well-maintained burner system is safe and easy to operate.

At Start-Up Turn on the Gas and Check Pilots and BASO

First make sure your stack is clear of all gases and that your damper is removed.

Turn on the gas to your pilots and burners. Check the regulator gauges if you have them.

Light the pilot. Your pilot light should burn bright blue. If it is yellow, it may not be getting enough oxygen. You most likely have dust or other grit in the pilot. Shut off the gas and clean out the pilot with a small brush. Air out the kiln and start over.

If your pilot is clean and you still have a yellow flame, you may have a problem with the oxygen level in your kiln area. Check for proper air flow in your area and be wary of carbon monoxide poisoning.

If the pilot is bright blue, you can continue to check the BASO valves. Light the pilot and burners. Blow out the pilot and make sure the BASO valve shuts the burners off.

Pre-Heat the Stack and Light the Burners

The most common error in firing is not clearing your kiln of fumes before you light your main burners.

Get the stack pulling up before you light the burners. Remove your damper, use a Bernz-Omatic type gas torch to warm the stack, or, if nothing else, light newspaper on fire and push it into the damper slot. This will help the air to start moving in the right direction.

The BernzOmatic is a great aid for lighting kilns. The new ones have a quick start feature. If you have to relight that kiln at 1900°F and things are really hot, the torch comes in very handy. Many a potter has burned fingers trying to light big power burners with a paper match.

If your chimney is pulling air from the kiln, the main burners can be turned on with little fear. If your burners are backfiring, turn them off. Backfiring happens when there is insufficient air movement.

After the burner lights, there should be no gas smell or hissing. Strange noises from the burner, like a screaming sound may mean gas is burning at the orifice. This can happen if you are firing really low and air pressure pushes the flame back to the orifice. This is very dangerous as the tube will heat up and turn red.

Again, this is generally caused by lack of proper air flow. Turn everything off and start over.

Wait, then clear your kiln and stack, preheat the stack and try again. Make sure the heat is going up the stack, instead of cold air coming down.

Start-Up Checklist

- Make sure the stack is clear of gases.
- Remove the damper.
- Open the main gas valve.
- Check the regulators.
- Open gas valve to the pilot and burners.
- Test the pilot and BASO valves: Light the pilot and burners. Blow out the pilot and make sure the BASO valve shuts the burners off. (You do not need to do this every firing.)
- Heat the stack with your BernzOmatic torch.
- Relight the pilots and one burner on low.
- Turn the second burner on low.
- Let the burners fire for 15 minutes.
- Turn the kiln up to normal firing pressure.

The First Hour of Firing

The most common accidents happen in the first hour of firing, as the kiln has no stored heat. If the burner sends raw gas into the kiln it may explode.

If you find the kiln is not working properly in the first hour, shut it all down NOW. TURN OFF THE GAS. Open the damper and exhaust all the fumes and gases from the kiln. Re-warm the stack with a torch, and start the process of lighting again. Never just turn the gas back on. This cannot be stressed enough.

After the kiln has turned red inside and the bricks have a slight glow, any raw gas or any fuel will ignite from the glowing walls or kiln furniture. A kiln gets safer the longer you fire. It is that first hour when the kiln is black inside that the danger is greatest.

Be near your kiln and watch it closely for that first hour. Make sure it has a great flow of heat going through it. The pilots should be working well and have clean blue flame. The damper should be set so that a great deal of air goes up the chimney. Check that the chimney is pulling the gases up and out.

Any time you smell a great deal of gas, you should not turn on anything electric, as this may create a deadly spark. Do not use a phone or operate light switches in the building for the same reason. Just shut down the gas. Even an hour of shut down will not harm the pots. They don't care. Just close the damper and get the kiln set for re-ignition.

When you know that all is in order, go through the checklist again before you relight the kiln.

During Firing Create Air Movement Around the Kiln

During the firing, the structure that covers the kiln must be kept cool (and damp if possible). Fires around the stack are common. If that stack gets really hot, it can transfer heat to the structure. Air flow is critical.

The more air you can move around a firing kiln the better. Dead air trapping heat is a primary cause of fire. If your kiln is in a building, make sure windows are open, and fans are running. An old box fan on the floor moving air towards the kiln is a good thing. Big attic fans mounted

in your studio wall are great for venting a big kiln.

A smell of burning wood is a sign of imminent fire danger. A good potter learns to listen, smell and watch the kiln. Anything that is different or unusual should be checked immediately.

Beware of Carbon Monoxide

Besides fire, the other major safety hazard is carbon monoxide (CO) poisoning. This must be watched for at all times, especially during reduction firing.

The best warning sign for a potter is **headache**. If you have the slightest headache, dizziness, or nausea, leave the area immediately and get fresh air. Another indicator of CO poisoning is a red face, neck, or chest.

Never fire a kiln in the room you are working in. Never. You should only enter the kiln room to check it. Check the firing, then step away. Never fall asleep while you are firing. This is a recipe for disaster.

Carbon monoxide is odorless and invisible, so careful monitoring and maintenance of your gas fittings is critical. At various times during the year use a soap wash to check all gas fittings. Make sure they are tight and safe.

Tend the Kiln

Kilns that have a responsible and duty-honored potter at the helm will fire for many years. Do not leave your kiln untended.

Always have an alarm clock or oven timer with you when you fire. We wonder how many kiln disasters happen when the potter is sound asleep. Remain sober! This is not a party. Never assume anything when firing a kiln. If you are

fully prepared, confident in your kiln and understand that bad things can happen, and be prepared for those events, your confidence soars. Sloppy practices will always lead to disaster.

Be Aware of Signs of Trouble

See, smell and hear your kiln. Know the signs of trouble, and never ignore them.

Signs of Trouble

- Headache, dizziness or nausea.
- Smell of gas.
- Smell of burning wood.
- Strange noises from burner.

Organization and keeping to a plan is still and always will be a must for firing fuel-fired kilns. “Pilot error,” sloppy schedules, and not having good safety in mind are almost always at the root of kiln accidents.

At Shut-Down Bleeding Your Gas Lines

When shutting down a propane system it is prudent to turn the gas off at the tank, and let the gas burn off at the burner until no gas is left in the line. Then shut down all the valves back to the tank.

When I turn off my natural gas kiln at home, I blow out the pilot and let the kiln shut down using the BASO valve. Then I walk back through the system shutting all the on/off valves. In all cases, your kiln is ready to start up again the next time you fire. There will be no surprises.

Do a visual check of your ceiling, stack, and entire kiln area to make sure all is cool and safe, and clean up the debris so you are ready for your next firing.

Mel's Story

My kiln is in a wooden studio/attached building. Years back I installed an asbestos board 8'x10' on my back wall. I have added a used brick wall in front of that backer board. The asbestos cannot flake off, and it sure is fire proof. I have mounted six fans in the room. The most important fan is an attic type fan that pulls hot air out of the room to the outside. The ceiling has a large turbo fan mounted.

Behind the kiln is mounted a small summer fan that just moves air. Across the top of the kiln blows air from a six-inch electric fan. All the fans are turned on when the kiln is lit. Several of the fans are on rheostats and can be set at very low speed. As heat builds up in the hot summer, I can increase the fans rpm's.

I keep a water-filled garden sprayer on a fine mist setting. As the kiln fires and the room gets warm, I spray a mist on the ceiling and back wall. This is just a bonus system that makes me much more comfortable. I have also painted my ceiling and back wall with “Fire Paint” from contegointernational.com. It is a Kaowool-based paint that keeps a wall or wood from combusting. It is not totally fire proof, but it will sure slow down a fire.

A Cautionary Tale **by Fred Paget**

A gas kiln is something that needs to be used with a great deal of care and a full awareness of the possible dangers it presents to the unwary potter. A gas kiln is a mighty engine for the production of reducing gasses. These are mainly carbon monoxide and some hydrogen. These hot gasses do the reduction we are hoping to get in our glazes but the carbon monoxide especially can be a deadly danger.

In February, 2000 I was firing my Kaizan kiln paying careful attention to the Oxyprobe and the pyrometer and entering the readings in a log book. I was seated right in front of the kiln door and I got a snoot full of carbon monoxide that was coming out of the slight leak in the door. I got up to go in the house and walked about 20 feet when I passed out (the medical term is syncope).

I fell forward and struck my face first on a camilla bush that had a stubby dead branch that punched a hole in my cheek. Then, my face hit the cast iron armrest of a little park bench we had there, and I fell down the one step to the patio deck. My face hit the deck. I was out cold. My wife, in horror, saw the fall and immediately called 911. The paramedics got there in record time—only about 5 minutes. They stabilized me and took me to the hospital. They cut off my shirt while doing this and Nan, my wife, said my chest was red—a sign of carbon monoxide poisoning.

At the hospital in the next few days they patched up my face and put back my upper jaw, which was broken, with three teeth and a jawbone fragment loose. My jaw was wired shut for 6 weeks.

The worst damage to my head was the total ruin of my left eye so it is completely blind. No response to light at all. The most skillful of Marin's plastic surgeons worked on me for five hours patching up my face.

The next thing that happened was I got clots in my leg veins that made it very difficult to walk at all and I spent 21 days in the hospital altogether as I had to go back twice because of my legs.

While in the hospital they gave me every test they could think of to find out why I fainted. Nothing was found. The carbon monoxide does not linger; if it doesn't kill you it goes away in hours, leaving no trace.

The hospital bill must have been astronomical, but I had a 100 percent HMO and I never was asked for money. The next year the HMO closed up shop in our county. I think I put them out of business.

It is now eight years later and I deal with my one-eyedness pretty well and walk a lot better now, but I tire quickly on hills. Even so I managed over 1000 steps up the trail in the Yellow Mountains of China. I wrote a Clayart posting about this accident while in the hospital under treatment.

13

FIRING TIPS FOR GAS KILNS

There is perhaps more mystery and “hocus pocus” about firing kilns than any other subject in the universe. The subjects range from long candling to fast fire, no reduction to heavy reduction, and on and on.

There have to be some standards, and perhaps the best place to look is industry. Industry does not care what Bernard Leach had to say; they care not what “Wally at the junior college” has to say. Industry bases everything on results based on solid principles of engineering and science.

Industry hires some of the best ceramic engineers in the world. They understand thermodynamics and are very conscious of the economy of fuel use as well as the use of “space age” materials. If we discuss kilns and firing with professional engineers, we should be able to learn a great deal.

Several concepts come forward and must be studied at length. But first let’s look at the use of an age-old firing aid—the cone.

Understand Pyrometric Cones and Their Use in the Firing Process **By Tim Frederick**

Pyrometric cones have been in use for over 100 years to help control and measure the firing process taking place in the kiln. A line of pyrometric cones was developed by Edward Orton Jr., and is still produced today by the Orton Ceramic Foundation, located in Westerville, Ohio.

What is a Cone and Why Should We Use Them?

Cones are tools used to measure heatwork, the relationship of both time and temperature, inside the kiln chamber. They do not measure just temperature. The cone reflects what is actually happening to the ware in the kiln, since they are manufactured from the same inorganic materials used to make the ceramic bodies and glazes. They will react to the combination of heat and time in a similar manner. Due to this fact, it is important to use witness cones in wood, gas, and electric kilns, to ensure that the ware was fired properly.

Pyrometric cones have a slender pyramid shape. These pyramid shaped cones are pressed from carefully controlled compositions of ceramic materials. Each composition has been formulated to melt at a specific temperature range. Each cone composition has a number ranging from 022 (the coolest cone), used for decoration on ceramics, to cone 42 (the hottest cone), used in special industrial applications.

As cones absorb the heat being produced in the kiln, the cone compositions begin to melt and form glass. At a certain point, enough glass will have formed to cause the cone to bend, indicating the amount of heatwork taking place inside the kiln chamber.

As mentioned, cones reflect what is actually taking place with the ware. It will indicate when the body or the glaze is reaching the maturation point. Most ceramic materials such as clay bodies, casting slips, glazes, or other decorative materials, have a cone firing range on the label.

Cones can be placed in various positions in the firing chamber and the results will indicate if the firing was uniform or if there are hot and cold spots in the kiln. This information can be used to assist in the loading and firing of the kiln to obtain more even heatwork to all of the ware.

The cone is a great diagnostic tool that allows us to evaluate kiln performance, help to monitor the kiln to prevent over firing, and can act as a shutoff device in some kilns equipped with a kiln sitter. For kilns equipped with electronic controllers, the cone can act as a calibration device. If the controller temperature



photos : Mel Jacobson

Cone numbers range from 022 (coolest) to 42 (hottest).

differs from the expected equivalent temperature of the cone, but the cones are at the correct bending angle, then the proper heatwork has been achieved. These different temperature readings can be caused by many variables, such as how fast or slow the kiln is firing. This can be affected by the power supply in your location. If you start to see differences in the cones as the number of kiln firings increase, this could indicate failing thermocouples or deteriorating elements. Cones can also supply data on other problems, such as irregular atmospheres in gas and wood kilns. The color of the cone can indicate if reduction atmosphere (the lack of enough oxygen) is present. It is a good idea to keep a cone log and cones from several firings so that they can be used as a comparison.

Self-Supporting Cones or Large Cones

The self-supporting cone is the ideally suited for use in your studio especially in electric or small gas kilns. These cones serve the same purpose as the large cones, but the mounting angle and height are built into the cone to eliminate any error. The other advantage is that these cones

do not require a plaque or clay wad to hold them during the firing process. Because of this, you do not have to make your plaques ahead of time, and they allow for easy placement in the kiln. Large cones mounted in a wad of clay may be better suited for wood-fired or gas or other fuel-fired kilns, due to a lot of movement in the atmosphere in the kiln. Some kiln atmospheres (wood, salt and soda) may have an effect on the melting point of the cone. Small shelters made from clay slabs can be set over the top of the cones to protect them from the ash and soda vapors being deposited directly on the cones. Even in these types of atmospheric conditions, the cones will still be a good guide to what is happening in the kiln.

Use of Cones

When using cones to visually check conditions in the kiln, it is very important to have the mounting height and the proper angle with the bending face of the cone in the proper position. Self-supporting cones do all of this for you, but large cones can be easily mounted in the proper position in a wad of clay.

The three cone system is recommended as the best way to visually monitor the kiln either during or after the firing. For example:

Guide Cone (Cone 06)

One cone number cooler than the firing cone.

Firing Cone (Cone 05)

Cone to which you are firing the kiln.

Guard Cone (Cone 04)

One cone number hotter than the firing cone.



photos : Mel Jacobson

The three cone system is the best way to monitor the kiln.

This system allow you to determine if you underfire or overfire, and by how much, using the bending angles of all three cones. More detail will be given in the section on interpretation of cones.

Cone Placement

Cones should be placed at the top, middle and bottom of the firing chamber to check the heat distribution during the firing. It is highly recommended to use cones regularly in every firing so you may quickly detect any changes that may occur. The use of cones is the most inexpensive insurance you can buy to protect your firing process.

Heating Rates and Hold Time

Heating rates and hold times can change the amount of heatwork that the ware will receive.

Heating rate is important to know, since many physical and chemical changes occur when firing a ceramic body, and you may want control of the heating rate during the firing process. When the heating rate is known, especially during the last stages of firing, it becomes much easier to understand the temperature equivalents presented on the cone charts. It can also help to explain why

the temperature reading on your controller or your pyrometer may differ from the equivalent temperatures listed on a cone chart.

Heating rates are preset in digital controllers with the cone fire programs and are listed in the kiln manual. Your kiln may not follow these ramp rates exactly due to differing power supplies, density of the load, or other variables. The cone fire programs in the controllers take this into account. The witness cones will indicate if the kiln is achieving the proper amount of heatwork.

Hold time or soak time can be an important tool used in the firing as seen in the following illustration. One hour of soak time can bring down the next higher cone. If your cone is bent to a 40 degree bending angle and you would like it to bend further, the addition of a 15 minute soak might bring it down to an 80 or 90 degree bending angle. It may take a couple of firings to find the exact amount of soak time that you want.

Short soaking periods may not affect cone deformation to any great degree, but you will probably see some movement of the cone. Long soaking periods will affect the amount of heatwork taking place and should be considered when holding for extended time in a wood firing, as an example.

Note: See Chapter 14 for examples of firing segments.

How to Interpret Cones After the Firing

When you unload the kiln, place your sets of cones on the table for further study. You may want to mark each set's location on the cone or cone plaque.

You can use a measuring template that shows the bending angles to measure each cone (Orton has these) or you can base it on a clock position.

As you begin to study the measured bending angles, you can compile all of this information into a plan that will work for you. The most important observation would be if your ware looked okay. As an example: if you are firing a glaze load to cone 06 and the tip of the cone was at a bending angle of 60 degrees and the glazes looked good, then you would want to aim for this cone position all the time.

You will probably notice over a period of time that your firings may vary due to load pattern and density, electrical power differences, and other possible variables. If the bending angle of the cone varies to either side of the 60 degree position you are aiming for and the ware still looks good, do not worry. This might only be a few degrees in equivalent temperature.

If the cones begin to vary to a significant degree, such as 30 or 40 degrees to either side of the position you usually fire to, this is the indication of a possible problem such as a broken heating element or a bad thermocouple. You may also notice a difference in the look of the ware. It is now time for a maintenance check on the kiln. This can also indicate a problem in fuel-fired kilns so that you can make changes where necessary.

Adjusting the Kiln

If the cones are not deforming to the desired position and the ware does not look the way that it should, there are some simple options to change this.

If your kiln has a controller, you can add some soak time at the maximum firing temperature to increase the amount of heatwork. An example would be to add a 15-minute hold to the firing to increase the bending angle of the cone. The specific amount of bend will depend on the load, the heating rate and other variables. It may take a couple of firings to determine the correct amount of hold time. This works very well if you are using the cone fire programs that are already in the controller. You may also use the cone offset feature that is built into the controller to increase or decrease the temperature (refer to your owners manual).

If you have entered custom programs into your controller, you can also raise your final maximum temperature set point by 5 or 10 degrees, causing more heatwork to take place and increasing the bending angle of the cone. Another option in custom programs is to lower the heating rate at the upper end of the firing curve to allow more time for total heatwork to be developed.

If the kiln has over fired and the cones have deformed past the desired position, you can reduce the amount of soak time, you can lower the final set point, or you can possibly increase the heating rate if your kiln has that capability. This will change the amount of heatwork taking place.

If you have a manually controlled kiln, it is more difficult to implement any of these options, but not impossible. You can slow down the firing by adjusting the control knobs, as an example.

In a fuel-fired kiln, it is also possible to make changes such as extending the amount of firing time to let your firing cone fall further before ending the firing or adding a soaking period at the end by adding a smaller amount of the fuel to hold the temperature at the present point.

Summary

For electric, and some gas kilns, controllers are precise instruments that allow the firing of kilns to become easier and more accurate. They ramp up or down at controlled rates, allow for additions of hold time, and provide the end user with input to the firing process. But even in this age of digital technology, we still measure the reactions that take place in ceramic materials by a cone number. The pyrometric cone continues to be the most accurate and best measuring tool to provide you with the same results of heatwork that takes place with your ware.

Cones are the best inexpensive insurance you can purchase to monitor your firings. They are also a great tool to use in understanding and obtaining the best results from your controller and kiln. Cones should be an important part of your firing plan. Use the information they provide so that you can always have the best of firings.

Tim Frederick was a Product Support Specialist for the Orton Ceramic Foundation, a former editor of Pottery Making Illustrated and associate editor of Ceramics Monthly. He now is associated with Diversified Ceramic Services, Inc. providing refractory and mineral products to the ceramic industry. Tim has B.F.A. in Ceramics from Ohio State University and has been a potter for over 40 years.

Firing Tips

Leave Plenty of Room when Stacking

Leave room, lots of room, around pots and between shelves. If you cannot get them in, good, leave them for the next firing. Those extra pots may just ruin the entire load.

One of the chief causes of failure is an overloaded kiln. Overloading keeps the heat from circulating and the kiln from breathing. If you want good reduction throughout the kiln, leave room for circulation.

Stagger your shelves and leave inches between them. Let each pot have its own space and keep at least a big thumb distance between pots. Do not crowd the ceiling of the kiln.

On the flip side, a half-load firing is a big waste of fuel. Get busy and make those extra pots, it is worth the effort.

A Long Pre-Heat is Unnecessary

What good does a long pre-heat do for a firing? In most cases, nothing. It is a great waste of fuel. If your pots are dry, the glazes set and your kiln is totally dry, then it is prudent to start the kiln with a great deal of energy. Fill that box with as much heat as you can muster. Before a kiln can really get going, you have to heat everything in the kiln. What takes the most energy? Shelves, posts, kiln furniture and the walls. Then the pots begin to warm. Potters think pots, but engineers think about the entire kiln and everything else that goes into that kiln.

Consider Candling and the K Factor

If a potter starts the kiln on low and leaves it for six hours, the heat will begin to soak through the brick. It destroys the K factor. If the bricks are heated all the way through, there goes the heat to the outside. When you fire, you want to get the firing done before you lose the K factor. IFBs are wonderful insulators, so why destroy their best feature?

We are beginning to understand that many more interesting things happen during **cooling** than happen during the rise in temperature. Observe what happens when you cool slowly, downfire, or relight your kiln. What happens when you crash cool from max to 1900°F? Experiment more in cooling than firing up.

A Very Gentle Warm-Up is Enough

You can warm your kiln to rid it of moisture and protect your shelves and furniture, without pre-heating it for hours on end. Gently warming your kiln is not the same as pre-heating. I warm my kiln overnight. I keep the gas very low, leaving a tiny opening in the flue, maybe a half inch. I use a very small burner, about 10,000 BTUs. It is really a large pilot light. I try to warm the kiln to about 400°F.

My plan is to warm and protect the kiln shelves, melt the wax on the pots, and generally warm up the kiln box. The secondary benefit is that the pots almost never crack, even large platters.

Get a Big Early Shot of Heat

When I start the actual firing, the moisture is completely gone from the kiln and I can turn the burners to full on and build heat as strongly as possible.

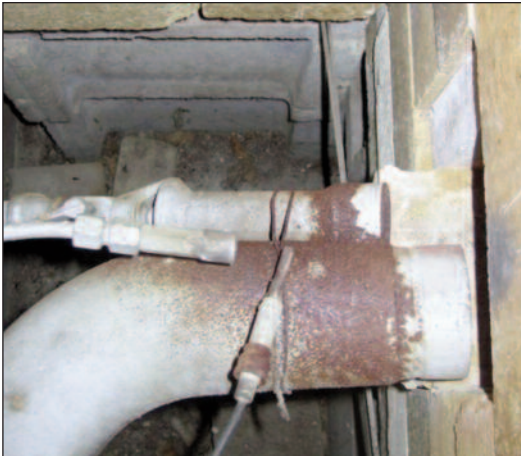

photos : Mel Jacobson

Mel uses a tiny 10,000-BTU burner above his regular burner to do a very gentle warm-up of the kiln furniture and pots.

In my opinion, you have to get a big early shot of heat. Kiln shelves and furniture have to get hot, then the pots, then the air inside the pots, then the air in the kiln, and finally the walls of the kiln. No sense messing around. Put the burners on full, open the damper, get that kiln to 1750°F as fast as you can.

By turning the kiln to its most powerful setting at the beginning, my kiln reaches high energy and begins to work well extremely fast.

As the kiln gets hot you can reduce pressure. Light reduction can happen with just a slight push-in of the damper. Wait for a slight flame to come from the center peephole.

The hotter the kiln, the less gas you need (in most cases—there is always one exception). Reduce for the entire firing; keep it light, with no belching smoke ever. What comes out of the stack from any gas kiln should be clean heat with no smoke; if there is flame you are making your gas fire outside the kiln and up the stack.

Firing Tips We've Learned From Industry

- Use lots of air—industry fires with a clean oxidized atmosphere.
- Use as much added insulation as you can. A Kaowool/fiber blanket on top of your kiln adds insulation and slows the cooling. Add a third layer of broken brick to the top of your kiln. Put all those old IFBs to good use.
- No long warm-ups. Fire as fast as you can, and then control the cooling.
- Bisque fire “bone dry” pots. Use your kiln top to dry pots and pre-warm them.
- Make sure your flue is not oversized. Do not heat the air outside your kiln.
- Fire for efficiency and fuel saving. Chart everything and keep honest records.

(Look at the Ward chart on page 124. Learn BTU costs and understand them.)
- Chart the bottom-line costs of firing your kiln. Know the costs and learn to reduce them with efficient firing. It's money in your pocket.
- Industry does not waste fuel. In many cases, it is their greatest cost of doing business. They care about fuel waste and quickly correct it.
- Look at alternative firing temperatures. Maybe cone 6 or less is in your future.

High Gas Pressure Can Cause Low Heat

Nils Lou has some great thoughts about high gas pressure and what it will do and where it will go. If you fire with gobs of pressure the heat will go lower in the kiln; when you fire with low pressure it seems to go up.

Use a Tuning Brick to Direct Heat

A tuning brick half way down the flame way will help divert the heat to the top of the kiln. But, without doubt, you have to find the sweet spot for that tuning brick. Perhaps it should be a brick with a small brick on top to form a T that you can turn as you experiment with it.

Deal with Uneven Firing

Uneven firing is a common problem. A half-cone difference from the top to bottom is not a worry, but two cones from top to bottom is a serious problem. You must consider what you just read about tuning bricks and gas pressure changes. Down-firing will help in many cases. It tends to even the kiln out from top to bottom.

It is important to be able to move heat around in your kiln. Learn to back off one burner, and turn the other to high. See if the heat will move across the kiln. See what happens when you fire with high gas pressure vs. low gas pressure. Chart what you change and document the results.

Heat must move through the kiln, and stacking the kiln with tight shelf placement can hinder that, so leave room. Never block the flue opening with a kiln shelf.

“Tune Your Kiln” for Better Firing

As your kiln ages it will open cracks between bricks. This opening up of the kiln may affect the firing. Plug those gaps with Kaowool fiber. Tighten your metal bracing. Tune the top if you are using a flat-top. Tighten the bolts just a bit. (You may have to replace the plywood form and jack up the kiln a tiny bit and take off the pressure, and re/tighten the entire top.) Make sure your arch bricks are tight and still in their proper place. A rubber mallet used to tap bricks back in place is prudent. Keep your kiln in good “tune.” Do not slather wet clay, or kiln mortar into cracks; it tends to shrink and then fall out, and often that drip or chunk will fall into your best platter—the one you need for a commission. Use fiber—it works. (Soaking fiber in ITC 100 and ramming it into cracks works well. It is a permanent fix, and does not shrink out of the crack.)

A Clean Kiln Fires Better

Keeping your kiln clean, inside and out, is important. Use a shop vac and clean the floor and side walls. Keep chunks of broken pots and kiln pieces off the bottom of the kiln. Clean and scrape your shelves from time to time.

Check your flue for debris, and slide the vacuum hose into the base of the chimney to clean it out from time to time. Make sure bats, birds, raccoons and other animals are not making a home in your stack. Look down it from time to time with a good flashlight. A clogged stack is a common cause of bad firing. Many potters cover their stack top with a five gallon pail. Make a long pole with a hook on the end and slide the pail over the top of the stack. (*See Bob Anderson’s video for an example of this.*)

Having a wind screen behind your kiln is a good idea too. Bob Anderson uses plastic screening hung with bungy cords around his kiln. He can move them as the wind changes. It is also good to screen your kiln from view of the neighbors.

A well-designed, tight, maintained kiln will be the best cure for the problem of bad firings and lost pots. The many potters that have written for this book will give testament to “even, well-balanced firing.” Remember, the best ecology system for a pottery is: no lost pots, 100% perfect firings, every time. The fuel that you burn is being used to make only well-designed, well-fired pieces.

Fire Only when Weather Permits

Weather affects firing. If you are experiencing storms or high winds, it may be best to turn off the kiln and start again later. A complete load of pots ruined or the waste of gas fighting the weather is just not worth it.

Firing with the least amount of fuel that will still give you heat rise is the best way to fire. Creep your gas pressure up after you put the kiln in light reduction. Don't blast it—that's not necessary. Once your kiln goes into reduction, it's often best to leave it alone and let it do its work.

If Your Kiln Stalls

The dumbest people in the world are not those who make mistakes, but those who make the same mistake over and over and over. “Hey, Mel, we fired this kiln 68 times and it stalled at 1900°F every time.” If my kiln stalled even once, I would change things fast. How often is the cure for a stalled kiln to turn down the

burners or the gas pressure? Often. Rarely does a stalled kiln need more gas or pressure.

There is a wonderful tip that if your kiln stalls you should either take off a foot of your stack or add a foot to the stack. You must do something. Turn down the gas, open the damper, close the damper and see what happens.

Remember, experience is a tough teacher—first it gives the test—and then the lesson.

Keep a Journal as You Learn to Drive Your Kiln

Take notes when you make experiment with your firing methods. Your journal will help you memorize what you do and you will learn to drive your kiln.

Try everything you can think of—one burner, two burners, full gas, low gas. Can you move the heat across your kiln? Put one burner on low, one burner full bore. Can you fire your kiln with a brick in the flame way? Move it around, and see what happens. How do you get heat to the top, to the bottom? Learn to control your kiln, not the other way around—don't let it drive you.

What happens when you fire a set of all flat dishes? What happens when you fire a load of 20-inch bottles? Every load is not a perfect mix of tall, short, thin and fat. How does your kiln react when you have every kiln shelf you own in one firing? You'll soon see why there is no precise recipe for firing any kiln.

Chart everything during experiments. You will be amazed at how your changes will affect your pots. A good reason for having a smaller kiln is that it can be fired more often. If you should lose pots or have a terrible firing, you haven't lost very much. It is very difficult to experiment with a huge kiln as the investment is too great.

Far too often potters get caught up in experiments with new glaze recipes. But firing changes may affect the quality of your work more.

When Joe Koons and I did experiments with temmoku, we were stunned at the subtle things that happened when we started to fire hotter and hotter, finishing with cone 13 oxidized. Without doubt, finding the wonderful colors at that temperature and atmosphere made all the difference in our research.

How the Kiln Atmosphere Affects the Glaze by David Hendley

During firing, a kiln is operating in one of three conditions: oxidation, neutral, or reduction. This is simply a measure of the amount of oxygen compared to the amount of fuel in the kiln. An electric kiln fires neutral because no fuel is being burned, but a gas, wood, oil, or coal kiln can be adjusted to be oxygen starved (reduction), have excess oxygen (oxidation), or have the optimal amount to combust the fuel (neutral).

When a glaze material is heated, its molecules are excited and are able to move more freely. Thus during reduction, the oxygen-starved atmosphere is able to "steal" oxygen molecules from the glaze material. For example, the carbon monoxide (CO) in the kiln and red iron oxide (Fe_2O_3) can combine to produce carbon dioxide (CO_2) and black iron oxide (FeO).

Often when you see a glaze recipe it is classified as an oxidation or a reduction glaze. With two big exceptions, most glazes will do fine fired in any atmosphere, with subtle, if any, differences.

Generally, oxidized glazes have a slightly brighter and more colorful hue, while reduced glazes have a more muted and earthy look. Variables such as temperature rise, soaking at peak temperature, total firing time, and cooling rate often affect the look and feel of the glaze more than firing atmosphere.

The two exceptions, when atmosphere is very important, are glazes which contain either copper or iron as a colorant. In reduction, a copper glaze can produce a bright red glaze rather than the normally expected blue-to-green. These are the famous Chinese ox blood or *sang de boeuf* glazes. Likewise, in a properly formulated glaze base, iron oxide, instead of producing the expected brown glaze, can make a transparent green-to-blue glaze, the prized celadon glaze. In addition, when a clay body contains iron, as many do, firing in reduction will darken and warm the color of the clay, as the iron changes from Fe_2O_3 to FeO.

Controlling the Kiln Atmosphere Tips for Reduction Firing

For years potters sought reduction firing in fuel kilns to achieve the subtle colors of old Oriental wood-fired kilns. Gray, tan, oatmeal and soft blue were the standard colors of the 1950s.

Many potters pushed the limits of reduction and fired with a great deal of smoke and carbon. Often the pottery suffered from over-reduction. It became brittle and the core of the body was blackened and weak.

Modern potters are learning to fire with soft reduction and even find that taking the reduction out of the firing will give them the very bright and lustrous colors that customers seek.

You can get reduction several ways: in with the damper, open the gas pressure some, and turn down the primary air on your burner. Often it will be a combination of those things, though I rarely turn down the primary air; it just stalls the quality of the flame and makes it dirty. Keep that flame bright blue.

A great way to study reduction is to turn your gas pressure up, close the damper a quarter of an inch at a time and measure the length of the flame from the peephole. My own rule of thumb is to keep the flame about two to three inches long. It will dance, so it is an average. The back-pressure flame will be largest from high on the kiln, with hardly any back-pressure at the lowest peephole near the floor. I always use the mid-level peep on the front of the kiln. The same one, every time. That will let me

know from firing to firing if things are the same. If the kiln is really loaded with pots and shelves, the back-pressure will be different. Learn to read that. Remember, each kiln will be unique.

Avoid Over-Reduction

Over-reduction as a result of too much back pressure, a damper in too far, and a dirty flame all lead to poor firing quality. And, without question, over-reduction wastes a great deal of fuel. It is important to find a balance of kiln atmosphere and the quality and color you are seeking for your work.

When You Finish Firing

When your kiln is done, open it up for a few minutes, damper out, peeps out, and let it clear. Then button it up and wait for 1900°F. When you cool to 1900°F (especially if you are firing bright reds), turn on one burner half way, and open the damper just a bit and hold the 1900°F for as long as you want, but never in reduction. Two hours is fine.

Your firing will be terrific. There are always exceptions to this method however. If your kiln is full of temmoku and celadon, you probably will not want crystal growth, so do not downfire. If you are doing shino and feldspar whites, let it go for three hours at 1900°F. Hank Murrow, who helped us understand this idea, can downfire for 6 hours with his shino glazes. Amazing surfaces.

Why Fire Cone 6 Reduction? **by Diana Pancioli**

First of all cone 6 saves money. Some say it costs less by almost a third compared to cone 10. Secondly, it helps preserve the kiln; cone 6 is much easier on kilns than cone 10. Thirdly, less gas used means less carbon emissions produced and a greener planet for polar bears and humans. Lastly, a reduction atmosphere makes beautiful glazes, whatever the temperature.

The development of cone 6 reduction glazes was originally an attempt to ensure that our expensive new gas kiln would last a long time. It has. Extending its life was my major goal ten years ago; saving fuel and reducing emissions were secondary, until now.

Having fired cone-10 R for many years, I also thought that it might be fun to add something to the literature by developing reduction glazes for a lower temperature. After several years of firing a handful of glazes at 6R, I applied for a summer grant to develop a better palette. I tested hundreds of glazes—anything I could find that was written for mid-range. The 22 glazes chosen for my project *Glaze Forward* are the product of that summer's research. (Thank you Eastern Michigan University.)

My first goal was to lower the temperature of traditional cone 10R glazes—celadon, temmoku, iron saturate, shino, copper red, etc. I revised some favorite formulae to the new lower temperature. The remainder were selected from many tests; I hoped to provide a range of colors, surfaces, and bases that would satisfy many tastes and encourage experimentation by others.

You will find a list of the sources of these glaze at *21stcenturykilns.com*. You will recognize some of them from cone 10. I renamed all the glazes according to their surface qualities so that (a) they would not be mistaken for their cone 10 versions and (b) their names would give my students a clue about each glaze's color and appearance.

I sent some glazes to the Alfred Analytical Testing Laboratory for leach testing. The results are reported in the notes at the bottom of each glaze page. Some testing still needs to be done.

John Hesselberth has been generous in allowing me to use a version of his software "Glaze Master" to present the glaze recipes, their photos, and their chemical analyses for you. (Thank you John.)

Diana Pancioli can be found at: dianapancioli.com. Her glaze recipes can be found at 21stcenturykilns.com

Cone 6 Reduction Thoughts **by John Hesselberth and Ron Roy,** **authors of *Mastering Cone 6 Glazes*.**

Now that Mel and this fantastic list of contributing potters have shown you how to build a great fuel fired kiln, we have an additional suggestion—consider firing it to cone 6 instead of cone 10. There is essentially nothing that can be achieved at cone 10 reduction that can't be achieved at cone 6 reduction! And that includes not only plain vanilla gas reduction but also salt and soda firing. And the fuel saving, while varying a bit from kiln to kiln and depending on how well you maintain efficient firing conditions, is conservatively estimated at one third! Some say it is half. We have to say it again. One third less fuel!

How Cone 6 Saves Fuel

How can that be you ask? For only 4 cones? Well, fuel-fired kilns become less and less efficient as the temperature increases. While all modes of heat transfer are involved, much of the heat is transferred by convection—interaction of the hot combustion gases with your pots, the kiln furniture and the kiln itself. And the rate and efficiency of heat transfer in convection is directly proportional to the temperature difference between those gases and the pots/kiln furniture/kiln. So as the kiln becomes hotter the efficiency drops lower and lower and most of the heat goes up the stack.

Now if you have been firing at cone 10 all your life and have a set of glaze recipes and clay bodies that you like and took a long time to develop, it is understandable that you may be reluctant to make the switch. But if you are just starting out working with a fuel fired kiln or, in particular, have been working at cone 6 in an electric kiln there is essentially no reason to fire at cone 10 except “tradition.” We would suggest it is time to move on and become a bit greener. Or if you are a production potter making your living from your pottery and are, therefore, firing often, why not switch to cone 6 and put the savings into your retirement fund.

While one can debate until the end of time whether electric kilns or fuel-fired kilns are “greener” than the other and reach no defensible conclusion—there are excellent points to be made on both sides and anyone who states one is greener than the other is speaking from incomplete knowledge. However, there is absolutely no question that in the same kiln cone 6 is greener than cone 10. The tiny

amount of additional fluxes (usually boron or, in oxidation, zinc) that have to be added to glazes to get them to melt at cone 6 is way more than offset by the fuel savings (a third less—or did we say that already?). And we have seen beautiful examples of shinos, temmokus, and other traditional cone 10 glazes that were fired at cone 6 reduction.

And for that matter, cone 6 oxidation produces beautiful results too if you make one simple change from traditional electric kiln practices—cool the kiln slowly.

How to Get Started

OK, you say, you’ve made the case. How do I get started? Here are some things to consider.

Lots of existing cone 6 glazes will do well in reduction. Most of the ones in our book *Mastering Cone 6 Glazes (MC6G)* will. The exceptions are the zinc base and its color variants and, possibly, Waterfall Brown. Any zinc-containing glaze is questionable in reduction because zinc oxide is easily reduced to zinc metal which boils at 907°C (1665°F). Unless you delay going into reduction until after your glaze has sealed over (usually about 1000°C [1800°F] or below) the zinc oxide will convert to zinc metal and go up the stack.

We mention Waterfall Brown because it is already pretty runny and has a high level of iron oxide. In reduction, iron becomes a flux and the glaze is likely to become even more runny. One *MC6G* recipe that does work well in reduction is Raw Sienna. It would be a good place to start if you want to try *MC6G* recipes.

For a commercial clay body, look for one that has less than 3% absorption at cone 6. Stay

away from ones that say they are good for a range of cones from, say, 4–9, unless you test them thoroughly at cone 6. Most clay bodies only have a useful range for functional work of a couple cones. Properly vitrified (no water leakage) cone 6 white clay bodies will work well at cone 6 reduction, but watch out for any iron-bearing cone 6 clays that are normally properly vitrified at cone 6 oxidation. Any iron in those clays will over-flux those types of bodies. You may need to mix in some more refractory clays with them to get the absorption right. On the other hand, many of the dark mid-fire bodies sold today are too open to prevent leakage—they may be just right at cone 6 reduction. You will have to test them to see how they do.

Another place to look for starting points for glazes would be Diana Pancioli's recipes which are on the website at 21stcenturykilns.com.

Diana has been a leader in cone 6 reduction and has done as much or more work as anyone in actually evaluating this firing process. Just be sure to read her comments on each glaze carefully. Some are only suitable for work where durability is not important. But she has tested many of her glazes and those where the durability was found lacking are noted in her “Comments” section.

Glaze Criteria

For durable, functional glazes, look for ones that meet the criteria for stability that we first established and published in *MC6G*—more detail is given there. Namely:

- They have enough silica (at least 2.5 and preferably >3.0 in Seger Unity terms).

- They have enough alumina (at least 0.25 in Seger Unity terms).
- They are thoroughly melted at cone 6. (This almost always requires at least 0.2 of either boron oxide or zinc oxide—again, Seger Unity terms. Glazes containing iron as a colorant may require a bit less since iron acts as a flux in reduction. But glazes with no boron or zinc are only rarely fully melted at cone 6.)
- They are not overloaded with colorants or opacifiers—copper being of particular concern.

A significant number of schools have already converted to cone 6 reduction in their fuel-fired kilns and more are doing so every year. The cost savings amid tight budgets is just too large to ignore. The result is that lots of experimentation is going on with C6R and the literature will soon be full of people's experiences. We would predict that in another 10 years there will be more written about C6R than is written about C10R and that hardly any potter just starting out will fire at cone 10. In fact, we already hear of quite a number of studio potters who have already converted or are seriously considering it.

So we urge you to give it a try. We think you will like it and never or rarely feel the need to take your kiln up to cone 10.

John Hesselberth and Ron Roy can be found at: masteringglazes.com

**Oxidation Firing
Thoughts on “Hank’s Soak”
by Hank Murrow**

It has been 7 years and 160 firings in my kiln since “Shinos in the Fire...an Odyssey” and “A Doorless Fiber Kiln” were published in *Ceramics Monthly*. Many potters have since shared their experiments with an oxidation soak during cooling, prompting me to review my original remarks and try to sum up what I have learned in those intervening 160 firings.

Though the procedure has been called “Hank’s soak,” it should be understood that until the 1950s, potters generally fired in large heavy kilns, whose cooling cycle normally gave a long clean period for crystalline development. In 1958 I learned to fire in just such a kiln—45 cubic foot and 13.5” hard and soft brick walls. It was not until 1974 that I built my first fiber kiln (for a ceramics factory) and realized that this was a kiln that could fire any way I wanted. Even at 400 cubic foot capacity, this lifting fiber kiln did not have a cycle of its own (the first firing went from cold to cone 8 in four hours!), and one had to decide exactly how the firing and cooling cycle should be designed. After building the much smaller 28-cubic-foot doorless fiber kiln, and through my studies of shino glazes, I decided to try a soak in oxidation to develop better fire color.

After this first firing success with a soak in oxidation, I determined the best time to initiate the soak by placing a series of shino draw rings beside the cones. I began to draw them beginning with shutdown, and pulling a ring out every 50°F during the cooling. I was amazed to find that no color showed until

around 1900°F, with strong color coming around 1800°F. Since my kiln has a built-in Oxyprobe, it was easy to tell when it had cooled to 1800–1900°F, relight the kiln, and set it for steady state and oxidizing atmosphere. During the subsequent 160 firings, I have varied the duration and the temperature of this soak, and have seen quite spectacular results from this practice. While glossy glazes have little to gain, any matte or semi-matte glaze is likely to show deeper color and a satiny surface from a soak, and some spectacular oil spot and hares fur glazes have resulted from the practice. Variations on “the soak” have become my practice with this kiln, whether I am firing the ware in oxidation or reduction.

A wonderful result of this work has been the continuing experimentation and reporting that has developed on the two listserves, *Clayart* and *Claycraft*, among potters of varying backgrounds and practices. Electric kiln users have joined the discussion, and it seems there is benefit to be had when added to nearly any temperature and atmospheric régime. It seems something of a paradox that so much variety and breadth of result should come from a kiln design having so little “personality” of its own. But then, we are artists, and paradox should be a staple of our inquiry. Soon, I will begin a series of fires, both oxidation and reduction, which will try a soak in reduction during the cooling cycle to see what might be had from that practice. I hope that discussion will be just as lively.

*Hank Murrow can be reached at murrow.biz
hankbmurrow@efn.org*

The Study Never Ends

When Joe Koons and I did the “Hares Fur” temmoku experiments (*see 21stcenturykilns.com*), we discovered that increased heat and very low reduction produced the results we had been seeking. We ended that study firing the kiln to cone 13 in an almost oxidized atmosphere. The color, surface and texture all became fluid at that temperature. I presented a paper to the ceramic engineers at the "National Academy of Science" in China. They were amazed at the glaze surface and final temperature that made the project a success.

Joe Koons has studied this glaze for nearly 50 years and we continue to do research together to find new answers to old questions.

14

ELECTRIC KILN SETUP AND FIRING

Electric Kilns: The Entire Story by Arnold Howard and Frances Darby

Safe Installation of the Electric Kiln **Selecting a Location**

In most home studios, the kiln goes in the garage or basement. An alternate location is a separate storage building. It is okay to place the kiln in an unheated building in cold weather.

Room Size & Ventilation

Avoid small, enclosed spaces such as a closet or small utility room. The kiln room must be large enough to avoid heat buildup around the kiln.

The minimum spacing between the kiln and nearby walls is 12". But in addition to the 12", plan for generous space around the kiln to promote good ventilation. Include room for steel shelves to hold ceramic ware. Maintain a minimum of 3 feet of space between kilns to prevent heat buildup around the kilns. Keep flammable material, such as shipping materials, out of the kiln room.

Consult building codes for recommended non-combustible wall material for walls that are

near the kiln. Cement board or masonry tile are good choices.

An Exterior Wall

Select a room with an exterior wall. You should vent the kiln, similar to the way a clothes dryer is vented, using a motorized vent. Fumes are vented outside through an exterior wall. If your kiln room has only interior walls, you will need to vent through the ceiling or floor to the outside.

Concrete Floor

Place the kiln on a concrete floor. Avoid wood floors and, of course, carpet. If you place a kiln on a concrete floor finished with linoleum tile, place a fireproof material over the tile to protect it from discoloration.

Be sure the bottom of your kiln is covered with an outside layer of sheet metal. Over-fired glazes can eat through the firing chamber insulation and drip onto the floor under the kiln. The sheet metal bottom prevents this.

Warning About Fire Safety Sprinkler Heads

In the kiln room, position sprinkler heads in the ceiling away from the kiln(s). I know of schools that were flooded because the sprinkler head, positioned above the kiln, turned on the fire alarm. Consider using a higher temperature sprinkler head in the kiln room or the type that senses smoke rather than heat. You could also install a Vent-A-Kiln vent hood, which will lower the temperature around the kiln.

Electrical Capacity

Before you order a studio kiln, measure the voltage in your building. (In the US and Canada it is usually 240 or 208. Both voltage systems use the same wall outlets, so you can't tell voltage by the type of outlet.) If you are not sure how to use a voltmeter, ask your power company to confirm voltage, or hire an electrician to check it. If you are in a commercial location, find out if you have single or 3 phase power. (Single phase: 2 hot wires and a grounding wire; 3 phase: 3 hot wires and a grounding wire.)

Besides knowing voltage and phase, be sure your building can handle the kiln's amperage. Some older sites cannot power a studio kiln without an expensive upgrade of the electrical system. See the kiln's specifications.

In some areas, the power company gives a discount for electricity consumed during the night. This is to encourage you to take advantage of excess generating capacity during off-peak hours. You might want to ask your power company if they offer this discount. If so, you will need a time-of-use meter installed.

Plan enough space and electrical capacity for additional kilns if you believe your kiln program will expand later.

Doorway Clearance

Make sure the kiln will fit through the necessary doorways to reach the kiln room. Ask your dealer for the kiln's exterior width. Some catalogs include doorway clearance for each kiln. There is nothing more embarrassing than receiving a kiln that won't fit through the doorway. I know of a school that had to remove a window to get a new kiln into the building.

HVAC: Heating, Ventilating & Air Conditioning

If you are installing a kiln in a school, mall, or other location with a central heating, ventilating, and air conditioning system, the building manager may ask how much heat your kiln will generate. A good estimate for studio kilns is 23,000 BTUs.

Electrical Installation

Please have only a qualified electrician wire your kiln circuit.

I recommend an electrical shutoff box near the kiln in addition to having a circuit breaker at the electrical panel. The shutoff box is necessary for direct-wired kilns, which can't be unplugged to disconnect the power. The shutoff box is also important for kilns with plugs. I recommend disconnecting the power when the kiln is not in use. If you unplug the kiln frequently, the spring tension on the wall outlet may eventually weaken. The shutoff box disconnects the power without having to unplug the kiln.



photo: Neil Winston

A direct-wired kiln with a blade switch box.



photo: Arnold Howard

Do not use your circuit breaker as a kiln switch.

Install the kiln within 25' of the fuse or circuit breaker panel. For every additional 50' from the panel, increase circuit wire size by one gauge.

But do not place the kiln right in front of the electrical panel. Keep the panel at least 3'– 4' away. Otherwise, the breakers may trip more easily on a hot day. This is because a circuit breaker is triggered by heat, and a nearby kiln can raise the temperature of the electrical panel.

Use a circuit wire size large enough for the wall receptacle amperage, even if the kiln amperage is less than the wall receptacle amperage.

Warning: changing the cord plug on your kiln may void your warranty.

Do not allow an electrician to use aluminum wire on your new circuit. Aluminum terminals corrode worse than copper and require greater installation care. Avoid using extension cords.

You may have a 240-volt circuit conveniently located where you will keep your kiln. But do not assume that the circuit is the correct size. Dryer circuits are too small for most studio kilns. Even if you have the correct wall outlet, you should verify that the wire and breaker sizes are also correct. Make sure the equipment

grounding wire is properly installed. Sometimes circuits have been installed by homeowners with limited electrical experience.

Note: Do not use the circuit breaker to disconnect the kiln. Frequently switching the circuit breaker will weaken it. Instead, use a shutoff box located near the kiln.

Direct Wiring the Kiln

Large studio kilns above a certain amperage are shipped without a plug and must be direct wired. This means that instead of using a plug and wall outlet, they are connected permanently to a terminal box mounted on the wall.

Direct wiring is better than a plug and outlet connection, because if the outlet corrodes, it can overheat. You can remove the plug and direct wire the kiln to eliminate this potential problem. But the kiln will no longer be portable.

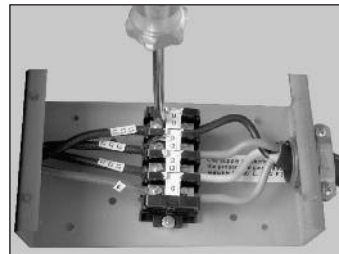

photo: Arnold Howard

Direct wiring your kiln will eliminate the danger of a corroded outlet, but you will sacrifice portability.

Please follow these guidelines in direct wiring a kiln:

- 1 Use a supply wire size large enough for the circuit amperage even if kiln amperage is less than the circuit amperage.
- 2 The supply wire must be suitable for 90°C (194°F).
- 3 Protect the supply wire with flexible or rigid conduit. You can also direct wire a kiln by removing the plug and using the existing cord.
- 5 Connect the supply wires at the wall using a high amperage screw-down connector block. Make sure all connections are tight.
- 5 Enclose the connection block in a suitable outlet box with cover.
- 6 Place the electrical shutoff box near the kiln.

The Plug and Wall Receptacle

If you choose to plug your kiln in, the wall outlet should be installed so that the kiln cord hangs downward—not upward—from the wall outlet. Do not place the outlet so close to the floor that the kiln cord bends at a sharp angle. In either case, the plug may not seat properly in the outlet, which will cause the plug to overheat

and corrode.

Make sure the plug is pressed all the way into the outlet. Heavy amperage plugs sometimes work their way out of the wall receptacle due to the weight and movement of the cord. This leads to poor contact between the plug and outlet.

Remove the plug from the wall every few firings and check for blackened plug prongs and melted or discolored plastic. At these signs of heat damage, replace both the wall outlet and the kiln's electrical cord. Make sure the receptacle feels tight when you press the plug back into the outlet. A loose receptacle indicates worn springs, which will lead to overheating. While the kiln is firing, occasionally touch the cord near the plug, and the wall outlet cover. It is okay if they feel warm, but if they are hot, turn the kiln off. Have an electrician inspect the circuit.

Note: Some people apply a light coating of oxidation inhibitor to the prongs on the kiln plug. This helps insure good contact between the plug and wall outlet. The inhibitor is a paste available at electrical supply stores.

Electric Kiln Safety

Following these safety pointers will add very little extra time to your daily firing routine.

There is little danger of serious burn from accidental contact if you exercise the same caution you would use with an electric iron.

- Place the kiln on the stand recommended by the kiln manufacturer. When a kiln is safety tested, the lab fires the kiln on the stand designed for it. Cinder blocks or bricks can inhibit the flow of air under the kiln. They can also change the kiln's heating characteristics.
- Place the kiln on a non-combustible surface.
- Do not install closer than 12" from any wall or combustible surface.
- Fire only in a well ventilated, covered, and protected area.
- Do not open the lid until the kiln has cooled to room temperature and all switches are turned off.
- Dangerous voltage: do not touch the heating elements with anything.
- Disconnect the kiln before servicing.
- Do not leave the kiln unattended while firing. Do not leave a kiln turned on at your studio while you are at home sleeping.
- Wear firing safety glasses when looking into a hot kiln.
- Unplug the kiln, or turn off the electrical shut-off box or circuit breaker when the kiln is not in use, especially if you are concerned that someone could turn it on while you are away.
- Keep the kiln lid or door closed when the kiln is not in use. This keeps dust out of the kiln. Also, should someone turn on the kiln while you are away, the closed lid will keep the heat safely inside the firing chamber.
- Never store things on the kiln lid, even when the kiln is idle. If people become accustomed to placing papers and other objects on the kiln, they may forget and do that while the kiln is firing.
- Remove all tripping hazards from around the kiln. Keep the kiln's supply cord out of traffic areas.
- Do not let the cord touch the side of the kiln; it becomes hot enough to damage the cord.
- Avoid using extension cords.
- Wear gloves when you load and unload your kiln. The gloves should be thick enough to protect you from glaze shards and bits of pyrometric cones that have stuck to shelves, sharp edges of broken ware, and sharp stilt marks on the bottom of glazed ware. Razor sharp glaze fragments can be so small that they are difficult to see.
- Do not remove the ware from the kiln until the kiln has cooled to room temperature. It is possible for thermal shock to break hot ceramic pieces. The sharp edges of broken ware can injure hands.
- After firing glazed ware in your kiln, examine the shelves for glaze particles. Sharp slivers of glaze stuck to the shelf can cut hands. Before rubbing a hand over a shelf, be sure the shelf is free of glaze shards.

-
- Fire only approved materials purchased from a knowledgeable supplier. Do not fire marbles, pieces of concrete, rocks, and other objects. Rapid heating to high temperature can cause violent reactions in many materials.
 - Avoid firing toxic materials such as mothballs inside the kiln. Mothballs create toxic fumes inside a kiln and can even explode.
 - Never fire tempered glass inside a kiln. It could explode.
 - Greenware must be bone dry before firing. Moist greenware can explode inside the kiln, damaging the ware and the kiln. Place a piece of greenware against the inside of your wrist. If it feels cool, it is too wet to fire.
 - Do not fire cracked shelves. They can break during firing, damaging the ware inside the kiln.
 - Store kiln shelves in a dry area. Moist shelves can explode inside a kiln.
 - If you smell burning plastic, turn the kiln off. Examine the wall outlet and supply cord for signs of burning.
 - As the kiln fires, it is a good habit to place your hand on the kiln's power cord to check the temperature. It is okay if the cord is slightly warm, but it should never feel hot. Make sure the plug is pushed all the way into the receptacle.
 - Never place extra insulation around the kiln in an attempt to conserve energy. The extra insulation can cause the switch box wiring to overheat and the steel case to warp.
 - Do not wear loose-fitting clothing around a hot kiln.
 - Remove flammable materials from the kiln room. If you fire a kiln in the garage, park your car outside. Remove the lawn mower, gasoline, and other flammable materials. Keep packing materials such as shredded newspapers out of the kiln room.
 - Keep unsupervised children away.
 - Keep a Class C fire extinguisher and a smoke alarm in the kiln room. Mount the extinguisher near the door to the room.
 - Do not breathe brick dust, kiln wash, or kiln repair cement. Prolonged exposure may cause lung injury. Vacuum the kiln with a HEPA filtered vacuum cleaner or a central vacuum that takes the dust outside.
 - Only vitrified ware should be used in a microwave oven. (Vitrified clay has been fired to a point where the particles become glasslike and no longer absorb water.) Non-vitrified clay such as earthenware is generally not suitable for microwave use, because the clay absorbs water. The water in the pores of the clay can expand rapidly enough in a microwave to cause the ware to crack or even explode. Ware that has been decorated with metallic glazes should not be used in a microwave oven.

Digital Controller Basics

Some controllers are more complicated than others, but they all do three things. Once you understand this, you can understand any digital controller.

- 1) A controller fires at a heating rate, or speed. This is usually measured in degrees of temperature change per hour and is similar to measuring the speed of a car in miles per hour. At a rate of 100° per hour, it would take 10 hours for the kiln to reach 1000°.
- 2) A controller fires to a target temperature. This is the same as turning the dial on an oven to 350° to bake potatoes.
- 3) After the controller reaches the target temperature, it can also hold, or soak, at that temperature. Baking potatoes at 350° for 45 minutes would be called a 45-minute hold.

The controller fires in segments, or stages. Each segment has a firing rate, target temperature, and hold. After the controller has fired the last segment, it turns off power to the heating elements.

Cone-Fire Or Ramp-Hold Mode?

The modern digital electric kiln has two firing modes: Cone-Fire and Ramp-Hold.

Most people use Cone-Fire mode to fire pottery. It is simple—just enter speed, cone, and hold time. Ramp-Hold mode, by comparison, seems complicated. Ramp-Hold divides the firing into segments, each with a rate, target temperature, and hold time as explained above. But some people prefer Ramp-Hold instead of Cone-Fire. Their reasons:

- 1) The standard thermocouple (temperature sensor) used in ceramic kilns is the K-type. Over its life, the K-type thermocouple drifts in temperature. This means the temperature readout changes slightly with time and wear. To compensate in Cone-Fire mode for temperature drift, you calibrate the thermocouple using a feature called Thermocouple Offset. It raises or lowers the temperature setting of the thermocouple.

To compensate in Ramp-Hold mode for temperature drift, on the other hand, just alter the target temperature of the segment that fires the cone to maturity. You don't have to use Thermocouple Offset.

For example, the witness cone on the shelf needs to bend just a little farther. Merely add 5 degrees of temperature rise to the next firing. Instead of programming a target temperature of 2232°F for cone 6, program 2237°F. If the witness cone is bent slightly too far, you can easily back off a few degrees the next time.

- 2) The latest digital kilns have candling and slow-cool features in Cone-Fire. Candling helps

dry the greenware; slow-cool gives certain glazes extra time for full development. In Ramp-Hold, you can program candling, slow cooling, and other features merely by adding more segments.

3) You learn more about firing when you program each step yourself.

4) You can experiment in Ramp-Hold more than you can in Cone-Fire. Ramp-Hold simplifies the firing of difficult glazes such as crystalline. If a friend or teacher gives you the firing schedule for a glaze, you can modify it easily in Ramp-Hold to obtain the best results for your kiln and materials.

5) You want to fire faster than Cone-Fire will permit. For instance, firing to cone 6 in Cone-Fire at fast rate takes 9½ hours. To fire faster, use Ramp-Hold.

More on Rate

The most confusing thing about Ramp-Hold mode is firing rate. Once you understand rate, the rest of the controller is easy to learn.

Rate is confusing because the rate on switch-operated kilns is adjusted by merely turning dials. You don't have to think about degrees of temperature rise. Microwave ovens require that you enter only high, medium, or low, and time at that temperature.

A car's speedometer measures speed in miles or kilometers per hour. To understand temperature rate, think of a speedometer that measures temperature change per hour instead of miles. This applies to both heating and cooling rates.

"Does the increase in temperature always assume a one hour time period?" someone asked. "If I need to get to 300 degrees in 30

minutes, would I set the ramp for 600 degrees per hour?"

The answer is yes. Rate is the amount of temperature change, up or down, in one hour.

Note: Degrees per hour is becoming our industry standard for controllers. A few controllers, however, use degrees per minute or number of hours to reach temperature. But once you understand rate, you can soon master any controller.)

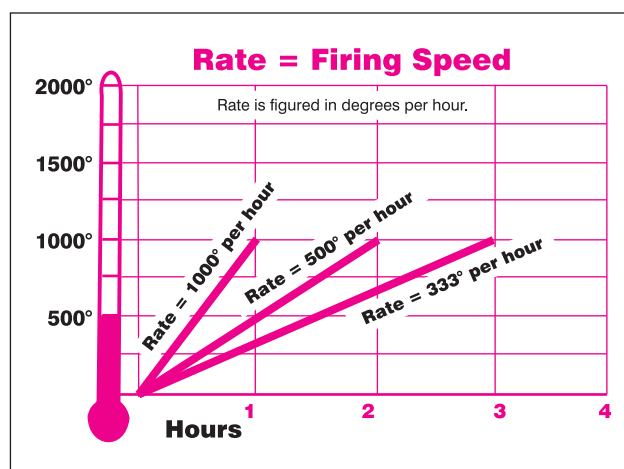

art. Arnold Howard

Suppose you wanted to fire from room temperature to 1000 degrees in 2 hours. To figure rate, divide 1000 by 2 hours. The temperature needs to go up 500 degrees every hour. Rate = 500 degrees per hour.

If you need to be more precise, subtract room temperature from 1000 before dividing by 2 hours. If room temperature is 100, then subtract that from 1000:

$$1000 \text{ minus } 100 = 900$$

$$900 \text{ divided by } 2 = 450 \text{ rate}$$

Segment Firing

Here is a sample 4-segment firing:

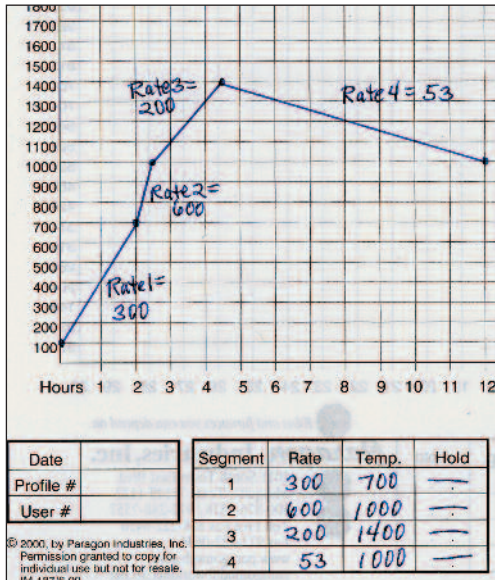

The sample 4-segment firing graph.

photo:Arnold Howard

Segment 1

Go from a room temperature of 100 to 700 degrees in 2 hours

Segment 2

Go from 700 to 1000 in 30 minutes

Segment 3

Go from 1000 to 1400 in 2 hours

Segment 4

Cool from 1400 to 1000 in 7 1/2 hours

Figuring rates for the above program:

Segment 1

700 minus 100 = 600 divided by 2 = 300 rate

Segment 2

You are firing from a temperature of 700 to 1000 in 30 minutes. First, subtract 700 from 1000. Answer: 300.

You are raising the temperature 300 degrees in half an hour. Since rate is measured in hours, and the temperature will rise 300 degrees in 30 minutes, rate per hour is $300 \times 2 = 600$.

Segment 3

1400 minus 1000 = 400 divided by 2 hours = 200 rate

Segment 4

1400 minus 1000 = 400 divided by 7.5 hours = 53 rate

If you are like most artists, who think visually, it is easier to understand the controller by drawing the program on graph paper. You can even make a rough sketch on plain paper showing slanted lines for rates and horizontal lines for temperature holds.

To master Ramp-Hold mode, first understand rate. Then segments, target temperatures, and holds will fall into place.

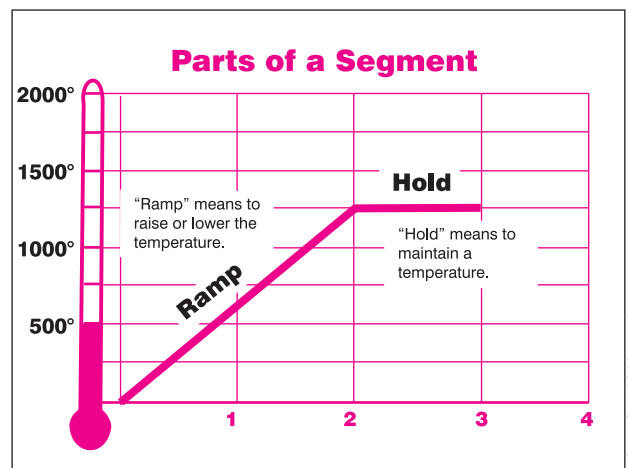

photo:Arnold Howard

How the Digital Controller Operates

A digital kiln is not complicated. When you understand how it works, you may find greater satisfaction in firing the kiln, because the controller won't seem so intimidating. Knowing how it works will also simplify the maintenance on your kiln. This information applies to basically any brand.

The Fuse

The first item in the digital circuit is a 1/2 amp fuse, which helps protect the controller from power surges. This fuse is usually located on the side of the kiln's switch box. If the controller display ever stops working, the first thing to check is the 1/2 amp fuse.

The Transformer

The next item in the circuit is a transformer, which converts the power to 24 volts AC. The transformer is easy to recognize. It is a square block wired between the power cord and the controller. The transformer is needed because the controller operates on 24 volts.

The Thermocouple

Wired to the controller is a heat sensor, which is a small rod that protrudes into the firing chamber. We call this sensor a thermocouple. It is made of two wires of dissimilar metal joined together in the thermocouple tip. When heated, the thermocouple actually produces a small voltage.

The Controller and Relays

The controller is a computer that converts that voltage to a temperature.

The controller is a switch that turns on the heating elements to maintain the correct temperature inside the kiln. But the controller

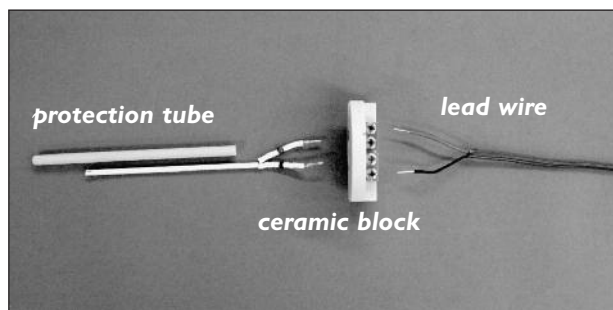

This is an S-type thermocouple.

cannot turn on the elements directly. It uses an electromagnet called a relay. When the controller needs to raise the heat, it sends a 12-volt signal to the relay. That energizes an electromagnet inside the relay, which pulls electrical contacts together. This, in turn, sends power to the heating elements. When the controller senses that the heat is about to rise too far, it shuts off power to the relay. (Some kilns have more than one relay.)

One of the most common questions I've heard is, "My kiln is making a clicking noise. Is there something wrong with it?" The clicking is the normal sound of the relays turning the elements on or off. Each time a relay receives the 12-volt signal, the contacts come together and make a clicking noise.

Another type of relay is the solid-state, which in theory outlasts the mechanical relay. However, the solid-state relay is more prone to fail due to overheating than is the mechanical relay. And when the solid-state relay fails, the heating elements stay locked on, overfiring the kiln. When the mechanical relay fails, on the other hand, the heating elements usually turn off.

A third type of relay is the mercury relay, noted for long life. It outlasts the other types of relays; its service life has been measured in

millions of on/off cycles. When it fails, the elements remain off. We have used the mercury relays for years in our larger pottery and glass kilns with outstanding results. Optional factory-installed mercury relays are available for many of our studio-size kilns.

Type-K and Type-S Thermocouples

You will notice a small rod projecting into the firing chamber of a digital kiln. It is the thermocouple, which reads the kiln temperature. Ceramic kilns use two basic types of thermocouples: Type-K or Type-S. Most kilns are equipped with the Type-K, which is less expensive than the Type-S.

The Type-K shows very little wear below 2000F. It is ideal for glass, silver clay, and low-fire ceramics.

Type-S is ideal for porcelain and stoneware. At these high temperatures, Type-S thermocouples show little wear. Some people claim that they last for years of heavy use. Type-S failure is ordinarily due to breakage rather than to wear.

Type-K and Type-S thermocouples are not interchangeable. Some controllers, such as the Paragon DTC 100, 600, 800, and 1000 series, and Sentry 3-key accept only Type-K thermocouples. The Paragon Sentry 12-key controller accepts either type, but you must select



photo: Arnold Howard

The thermocouple must protrude into the firing chamber $\frac{1}{2}$ "– $\frac{3}{4}$ ".

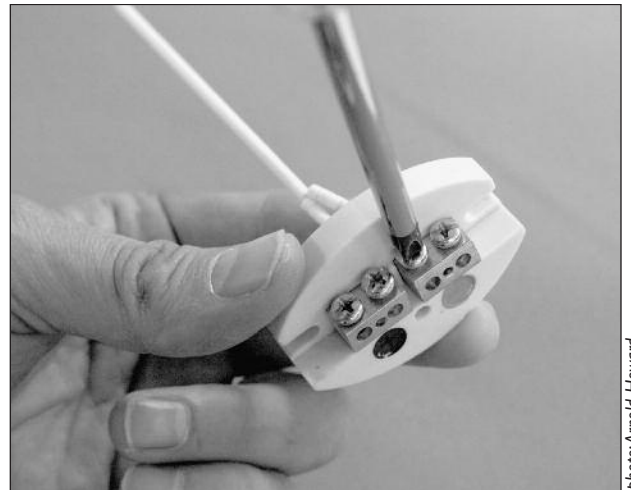

photo: Arnold Howard

To adjust the thermocouple length, gently change the gap between the thermocouple and ceramic block. Then securely tighten the 2 screws in the ceramic block. Caution: Do not sharply bend the two thermocouple wire ends. Otherwise they will break.

the correct thermocouple in *Options*. Some brands of controllers require a change in computer chip to accept the Type-S thermocouple.

Is the Thermocouple Type K or Type S?

Type-K and Type-S thermocouples each require different types of thermocouple wires:

Type-K

Yellow wire (+ terminal)
Red wire (- terminal)
Brown or yellow outer wire insulation

Type-S

Black wire (+ terminal)
Red wire (- terminal)
Green outer wire insulation

If you have the wrong thermocouple type wired to the controller, the temperature will be wrong:

Problem: Type-K thermocouple wired to a controller that is adjusted for Type-S: The kiln will under-fire.

How far the kiln will under-fire depends on the temperature. The higher the temperature, the greater the error. At 75°F, the controller will think the kiln has reached 100°F. At 500°F degrees, the controller will think the kiln is at 2000°F.

Problem: Type-S thermocouple wired to a controller that is adjusted for Type-K: The kiln will over-fire.

The higher the temperature, the greater the error. At 75°F, the controller will think the kiln has reached 75°F. At 2000°F, the controller will think the kiln is at only 500°F.

If the controller is matched correctly with the thermocouple, you can still get an error in temperature by using the wrong thermocouple wire. However, the error is not too noticeable: 10–30°F when the thermocouple wire is only a few feet long. The error becomes greater when the wire length increases, however.

How To Adjust the Kiln Sitter

Never lubricate the Kiln Sitter. Lubricants will only attract dust.

Your kiln will arrive with the firing gauge in place on the cone supports and the actuating rod inserted through the center hole. Remove the rubber band that holds the gauge in place; then remove the gauge. Save the gauge for future adjustment. Do not fire with the gauge in place!



photo:Arnold Howard

Remove the rubber band.

Store the firing gauge, Kiln Sitter allen wrenches, and storage bag in a handy place near the kiln along with a small bottle of kiln wash.

Most people think the firing gauge is only to keep the actuating rod from bouncing during shipping. Please do not throw the gauge away! You will need it to keep the Kiln Sitter adjusted to factory specifications.

Guide Plate Adjustment

1 Check the position of the actuating rod. (The actuating rod is easier to see if you hold a small mirror inside the kiln.) The rod should be centered sideways in the refractory tube's oblong slot. If not, loosen the two guide plate adjusting screws and move the plate to the right or left, as necessary.



photo:Arnold Howard

Step 1

Note: The easiest way to adjust the guide plate is to loosen the screws so that they barely hold the guide plate in place. Then gently nudge the plate sideways. If you loosen the screws completely, the guide plate is more difficult to adjust.

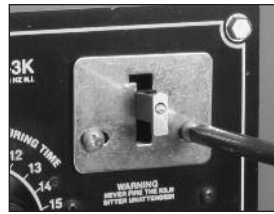

photo: Arnold Howard

Loosen the screws and gently nudge the plate.

- 2** After the rod is centered, securely tighten guide plate screws.
- 3** Test the full travel of the actuating rod. Watch the actuating rod inside the kiln as you move the release claw up and down. The actuating rod should be free to move within the tube without touching the sides.

If the rod does not fall freely to the bottom of the tube, check the guide plate to see that its slot is parallel to the direction of travel of the release claw. If not, straighten the guide plate and readjust rod centering. Be sure to retighten the two screws securely.

As the Kiln Sitter develops wear, the actuating rod may no longer fall freely within the tube. This is usually caused by a corroded tube assembly. Replace the tube.

Trigger Adjustment

- 1** Inside the kiln, slide the firing gauge over the end of the actuating rod and the two slotted cone supports. The actuating rod fits into the firing gauge hole.

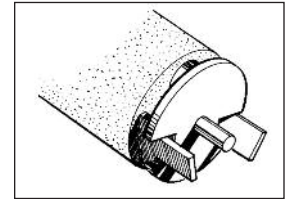

photo: Arnold Howard

Step 1

- 2** Lift the weight on the outside of the Kiln Sitter all the way to the fully raised position. At the end of the weight is the adjustable trigger. With the firing gauge in place, the trigger should just clear the release claw, coming as close as possible without touching. If the trigger is too high to clear the release claw or if it is too low, loosen the set screw in the center of the weight, move the trigger up or down until it just clears the release claw, and retighten the set screw.



photo: Arnold Howard

Step 2

Check the trigger adjustment with the firing gauge after every 12 firings.

If the set screw is too loose, the trigger will slide out of adjustment with repeated use. But if the set screw is too tight, you can strip out the threads.

Release Claw Adjustment

After you have adjusted the trigger height, check the amount of play between the trigger and the release claw. Raise the weight and lower the release claw over the trigger. Raise the weight and lower the release claw over the trigger.

Look at the Kiln Sitter from the side to check the play between the trigger and the release claw. It should be $\frac{1}{16}$ " (2 mm). To adjust, loosen the setscrew on top of the release claw.



photo:Arnold Howard



photo:Arnold Howard

Release claw adjustment.

Test the Mechanical Operation

- 1 With all kiln switches turned OFF, raise the weight and lower the release claw over the trigger. The weight **MUST NOT** be able to stand up alone, and the trigger **MUST** lean against the release claw.
- 2 With your other hand, hold up the end of the actuating rod inside the kiln. Let go of the release claw. The release claw should hold the weight up while you hold up the end of the actuating rod inside the kiln.
- 3 Set the Limit Timer clock. Push the plunger all the way in until it locks into position. (The Limit Timer clock **MUST** be set before the plunger will lock.)



photo:Arnold Howard

Step 3

- 4 From inside the kiln, move the actuating rod slowly downward until the claw releases the trigger. The weight should fall all the way to the bottom, releasing the plunger and allowing the button to pop outward to its original position. Repeat the operation 6–12 times to loosen the mechanism.



photos:Arnold Howard

Step 4.

For reliable operation of the Kiln Sitter, the kiln should be level. You can level it by inserting shims under the stand legs.

The Kiln Sitter: Replacing The Porcelain Tube Assembly

Replace the porcelain tube assembly when the movement of the sensing rod becomes sluggish or when the sensing rod is bent. Be sure the replacement tube assembly is the correct length for your kiln.

- 1 Disconnect the power to the kiln.
- 2 Make sure there is no cone or firing gauge in the Kiln Sitter.
- 3 Remove and save the screws at the side of the switch box that hold it to the kiln and remove the box, carefully pulling straight out to avoid damaging the Kiln Sitter tube. You may need to prop the box on a chair or

other object as you lean the box against the kiln. Leave the wires attached to the Kiln Sitter.

Note: While you have the Kiln Sitter out, it is a good idea to clean the back side of the Kiln Sitter with compressed air.

4 Remove the 2 screws holding the guide plate to the front of the Kiln Sitter.

5 Remove the guide plate.

6 Remove the 2 screws that hold the porcelain tube bracket to the Kiln Sitter.

7 Remove the porcelain tube and bracket.

8 Remove the nut holding the porcelain tube assembly to the tube assembly bracket.



Step 4.

photo:Arnold Howard



Step 5.

photo:Arnold Howard



Step 6.

photo:Arnold Howard



Step 7.

photo:Arnold Howard



Step 8.

photo:Arnold Howard

9 You will see a notch on the top of the new tube assembly. Align that notch with the pin on the tube assembly bracket. Install the washer and nut. (The washer goes under the nut on the front of the tube assembly bracket.)

10 Remove the release claw from the old porcelain tube and install it on the new tube.

11 Install the porcelain tube bracket to the Kiln Sitter.

12 Reinstall the guide plate to the front of the Kiln Sitter. Tap the guide plate from side to side until the rod is centered in the porcelain tube.

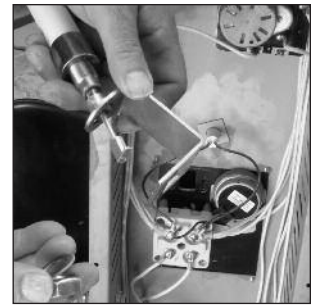

Step 8.

photo:Arnold Howard



Step 9.

photo:Arnold Howard

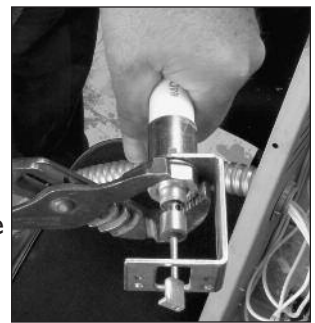

Step 9.

photo:Arnold Howard



Step 10.

photo:Arnold Howard

Note: The easiest way to adjust the guide plate is to loosen the screws so that they barely hold the guide plate in place. Then gently nudge the plate sideways. The guide plate is more difficult to adjust if you loosen the screws completely.



photo:Arnold Howard

(Step 12 is the reverse of step 6.)



photo:Arnold Howard

Step 13.

13 After the rod is centered, securely tighten guide plate screws.

14 Reinstall the switch box. Arrange the wires so they do not interfere with the locking slide that trips when the weight drops. (You can see how the locking slide works by lifting the weight, pressing the plunger, and then dropping the weight.) Also, arrange the wires inside the switch box so that wires do not touch the element connectors or the kiln case.

Check the Kiln Sitter adjustments before firing the kiln.

Electric Kiln Firebrick Maintenance

Kilns are hard working tools. After the first few firings, the steel case of a new kiln discolors and hairline cracks appear in the firebricks. This is normal.

Though the insulating firebrick is fragile enough to carve with a fingernail, it is a miracle of physics. It can routinely withstand temperatures over 2000°F, which is hot enough to melt copper, bronze, brass, and aluminum. When properly maintained, firebricks can survive many hundreds of firings.

The high temperatures inside a kiln cause tremendous stresses. Since the insulating firebricks expand and contract with each firing, cracks appear in the bricks while the kiln is cold. Do not be concerned with these. The cracks close tightly when the heated bricks expand and function as expansion joints.

Cracks in the firebrick bottom usually should not be repaired. As long as you are supporting the kiln with the correct stand and a protective sheet of steel under the bricks, the cracks in the bottom are nothing to worry about.

If you use silica sand on the kiln shelves, be careful not to allow the sand to seep onto the firebrick bottom. The sand will get into the cracks and widen them.

Do not be concerned with the line of light that appears around the edge of the door or lid at high temperatures. That light is due to the natural expansion of the firebricks and does not affect the firing.

Preventive Maintenance

Do not breathe the dust that forms when you vacuum the kiln or mix kiln wash. Wear a mask.

Vacuum the Kiln

One of the easiest kiln maintenance tasks is regular vacuuming. This is especially important if you fire glazes. Vacuum the kiln before every glaze firing.

Use the soft brush nozzle on a vacuum cleaner. Be sure to vacuum the element grooves, the inner surface of the kiln lid or roof, and the underside of kiln shelves. Vacuuming the grooves is essential if clay has exploded inside the kiln. Pieces of greenware that lodge inside the grooves can cause element failure. Vacuum the kiln often if you use silica sand on the shelves to support ware. Sand can ruin the elements if it filters down into an element groove.

As you vacuum the kiln, examine the walls for glass or glaze particles that have embedded into the firebricks. Dig these out carefully with a screwdriver.

Coat the Brick Floor

Coat the firebrick floor of your kiln with kiln wash. (The kiln wash must be rated to 2400°F.)

- 1 Pour water into a disposable container and add powdered kiln wash until it has the consistency of coffee cream. Stir until lumps dissolve.
- 2 Apply three thin layers of kiln wash rather than one thick layer. You can use a small paintbrush or a Chinese haik brush. Allow the kiln to dry before firing.



photo: Arnold Howard

Coat the firebrick floor with kiln wash or glass separator. If your kiln has sidewall elements, hold a piece of cardboard in front of the elements to protect them from contact with the kiln wash.

If the kiln wash cracks or flakes off, reapply it only to the bare spots. Do not remove the kiln wash from the firebrick floor and apply a fresh coat. This is unnecessary and messy.

Avoid splashing kiln wash onto the firebrick walls and sidewall elements. Contact with kiln wash destroys elements, often during the next firing. Leave the floor uncoated if your kiln has an element in the floor.

Top-Loading Kilns: Extending the Life of Top Wall Bricks

The wall area of a top-loading kiln that is most prone to damage is the top rim of sidewall firebricks. This is because people lean against the edge of the kiln to load and unload. Place as little weight as possible on the kiln.

Reduce brick damage by cutting a piece of plywood about 3"–4" wide shaped to fit over the edge of the kiln when the lid is open. The plywood should be curved to the shape of the kiln. Lean against the plywood instead of directly against the brick rim. The plywood will help distribute weight evenly over several bricks.

Be Gentle with the Kiln

During loading and unloading, do not touch the sidewalls of the kiln with anything. Do not allow a shelf to bump into the firebricks. The extra time and care you give when loading and unloading may add years of life to your kiln.

Allow only trusted people to load and unload your kiln. They must be gentle, or your kiln will quickly show wear. Do not let your students touch your school kiln until you have given them a lesson in care of the kiln. Lower the lid (or close the door) gently. Slamming the lid can crack the bricks the first time it happens.

Lids with a locking support arm: Fully disengage the arm before lowering the lid. Otherwise you can break the lid near the hinge. Lids with a spring counterbalance: Hold the lid handle and guide the lid until it is fully opened. If you let go of the handle too soon, the lid will slam back, damaging the bricks. From time to time, check the condition of the lid support or spring system and the lid handle.

When firing heavy loads, place a spare shelf directly onto the kiln floor under the posts. The shelf will spread the weight of the load over the entire floor.

Most large kilns are designed to be fired on a kiln stand. It raises the kiln off the floor and helps to dissipate heat under the kiln. The top of the stand should be directly under the kiln walls. A stand that is too small for the kiln will strain the brick bottom.

The kiln stand should be level and rock steady. An unlevel stand can stress the firebricks. A

stand that rocks can cause the kiln to move when jarred, knocking over ware against the sidewalls inside the kiln.

Remove Melted Glaze from the Bricks

If glaze drips onto a kiln wall or the kiln floor, repair before the next firing. Otherwise the glaze will re-melt and embed deeper into the firebricks. Remove by scraping gently with a putty knife. After removing kiln wash from the kiln floor, apply a fresh coat to the bare spot.

Repair Cement Techniques

The purpose of the firebricks is to:

- Insulate the firing chamber.
- Support the heating elements.

Do not repair damaged bricks as long as they continue to insulate the kiln and to support elements. (An exception: Dust is falling from the brick roof.) Most firebrick damage is cosmetic and does not affect the firing results.

Some of the reasons to repair firebricks:

- The lid coating is flaking onto the ware.
- Dust is falling onto the ware from lid cracks.
- Glaze or glass has embedded into a wall or floor.
- You need to plug a vent hole.

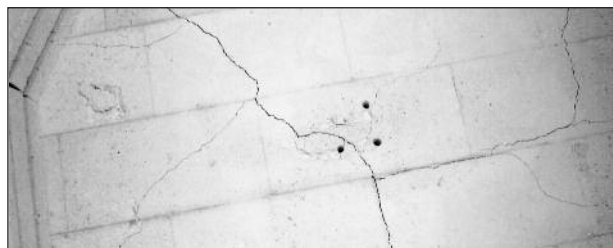

photo: Arnold Howard

These holes in the floor close tightly during firing.

Coating the Kiln Lid

On top-loading firebrick kilns, the inside of the lid and top rim of wall bricks can be coated for longer wear. Liquid Kiln Coating is a refractory cement that Paragon has formulated for coating firebrick lids here at the factory. (The door or lid of ceramic fiber kilns and front-loading firebrick kilns does not need the coating.) The coating hardens and protects the firebrick surfaces. One application lasts through many firings even though the coating will seem to disappear after the first firing.

Do not fire the kiln until the coating is completely dry. If you splash the coating onto an element, remove as much of the cement as possible from the element.

Coating that is applied too thick will flake off the lid after you fire the kiln. If the roof or inner surface of the lid peels, sand the peeled area and apply kiln coating to the bare spots.

If you are coating over a freshly patched firebrick surface, allow the cemented patch to dry first.



photos: Arnold Howard

Sand the peeled areas of the lid and reapply the coating.

Liquid Kiln Coating Instructions

- 1 Shake the container until the liquid coating is thoroughly mixed. Pour some of the coating into a bowl. Stir the coating just before you apply it to the firebricks.
- 2 Apply the coating with a large, soft sponge such as the type used for wallpaper. Moisten the sponge with water squeezing out the excess.
- 3 Dip the moistened sponge into the bowl of kiln coating. Wipe the coating over the lid surface. Work quickly, and wipe off the excess. The coating should be thin enough so that you can still see the grains of the bricks underneath.
- 4 Allow the coating to dry completely before firing the kiln.



photo: Arnold Howard

Work quickly and wipe off the excess.

Repair Cement Basics

We use Paragon's Liquid Kiln Coating & Repair Cement at the factory to make lids and bottoms. It comes in pint bottles.

- 1 The thinner the cement seam, the better. Try to make the two firebrick surfaces match as closely as possible for a thin seam.
- 2 Vacuum all firebrick surfaces that are to be cemented. Remove all traces of dust. (If you do not have a vacuum, you can remove dust with a dry paintbrush or with canned air. Do not breathe the brick dust.)
- 3 Spray a fine mist of water onto both firebrick surfaces before cementing. Mix 1 drop of liquid dishwashing soap to 1 cup of water. The soap reduces surface tension of the water to help it absorb into the bricks. Use a small spray bottle.

Note: Water is unnecessary if you work rapidly. The water on the bricks merely allows you more time to work with the cement.

- 4 After you have cemented the firebrick pieces and pressed them tightly into position, do not reposition the pieces. Otherwise the bond may not hold. If you move the pieces after the cement has set, you will see hairline cracks in the cement. In this case, remove the repair piece and cement and start over from the beginning.
- 5 Gently wipe off excess cement from the brick surface. However, do not sand smooth until the cement dries overnight.

Speed-Drying the Cement

Sometimes it is necessary to dry the cement quickly so the patched firebrick piece doesn't fall out of place. This technique allows you to patch difficult areas such as a lid or roof. Speed-drying the cement eliminates the need to hold a prop against the repaired lid while the piece dries.

After you have cemented the brick patch, heat the cement seam with a propane torch. Hold the torch 5–6 inches away from the firebrick surface for about 10 seconds.

Move the torch back and forth so the firebrick does not get too hot in one place.

(Otherwise you may heat-shock the wet cement.) Let the patch dry overnight before firing the kiln.

You can purchase a propane torch from a home improvement center. Buy the type that has a push-button igniter. When you press the button, a blue flame appears. When you release the button, the flame goes out.

For kiln maintenance, do not use the older manual propane torches. Turning them on and off is awkward. (You must first turn a knob to start the flow of propane and then hold a match under the nozzle.) The push-button type is much safer and worth the extra expense.



photo: Arnold Howard

Move the torch back and forth so the firebrick does not get too hot in one place.

Powdered Firebrick Filler

Do not fill in firebrick gouges or low spots with solid repair cement. When applied as a filler, the cement will break out later from the firebrick due to a difference in thermal expansion between the cement and the brick.

Fill brick gouges with Kaolin Grog mixed with repair cement. (Kaolin Grog, available from Paragon in 5 lb bags, is powdered firebrick.)

Kaolin Grog filler more closely matches the coefficient of expansion of the firebrick and stays in place. Add just enough cement to hold the Kaolin Grog together.

Note: The gouged firebrick floor shown in the photos does not need to be repaired. We simply used this as an example. Small gouges in the brick floor do not affect firing results.



photo:Arnold Howard

To fill gouges, mix Kaolin Grog with repair cement.

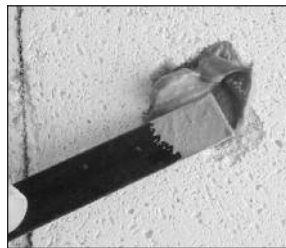

photo:Arnold Howard

Add just enough cement to hold the Kaolin Grog together.

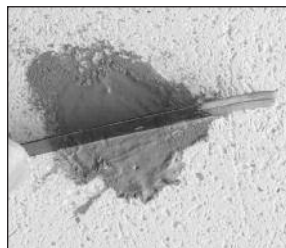

photo:Arnold Howard

Scrape away the excess.

Making Firebrick Patches

Patching a broken firebrick is not difficult. It just requires patience and a little practice. Make firebrick patches to repair the lid, walls, and floor of a kiln.

Firebrick Sanding Blocks

Use coarse sandpaper to make a sanding block. Remove the peel-away backing from self-adhesive sandpaper and stick the sandpaper to the block.

For sanding small firebrick sections, you may need a sanding block as small as ½" x 1". Banding steel, which is used to reinforce shipping crates, makes a good miniature sanding block. Bend a 6" piece of banding steel 90 degrees at one end. The length of the bend should be whatever size block you need, such as 1". Then cut the

sandpaper to the correct size, peel off the sandpaper backing, and press the sandpaper onto the outer bent end of the banding steel.

You can also make sanding blocks from strips of sheet metal, wood, etc.

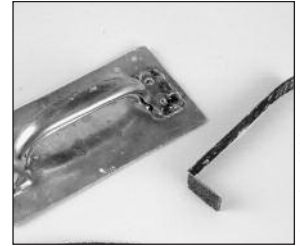

photo:Arnold Howard

Sanding blocks made with self-adhesive sandpaper. The block on the right is made from banding steel.



photo:Arnold Howard

The left sanding block is ¼" wide; the right sanding block is 1" wide. In the center is a hacksaw blade used to cut firebricks.

Repairing Damaged Brick

Practice patching firebrick scraps before working on your kiln.

1 With a hacksaw blade, cut an outline around the broken brick section. Cut a small rectangle or square.

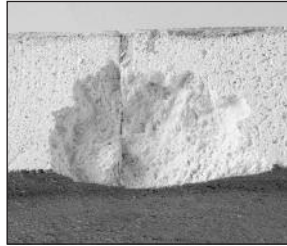

photo:Arnold Howard

Use this technique to repair wall damage where the lid touches the kiln wall.

2 Use the hacksaw or small sanding block to remove most of the brick within that outline. Then sand the bottom of the recess flat and smooth. If the repair section is small, you will need a miniature sanding block.

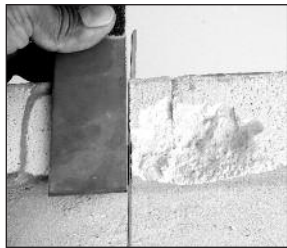

photo:Arnold Howard

3 After the recess is smooth, make a firebrick piece to fit into the recess. The piece should be a little smaller in width and depth so that the brick seam will be $\frac{1}{16}$ " or less on all sides. Spend time to make the plug fit precisely. A thicker seam than $\frac{1}{16}$ " may break later due to the difference in expansion between the firebrick and cement.



photo:Arnold Howard

Step 2

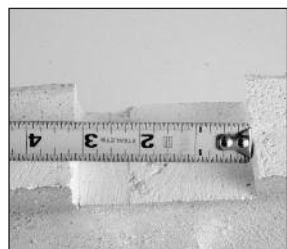

photo:Arnold Howard

Step 3

4 Use a brush, vacuum cleaner, or canned air to remove the dust. (Wear safety glasses when using canned air.)

5 Spray a fine mist of water onto all mating brick surfaces.

6 Working rapidly before the water dries out, wipe firebrick repair cement onto mating surfaces.



photo:Arnold Howard

Step 6

7 Press the plug tightly into place. Do not move it once the mating surfaces make contact. Hold the brick piece for one minute.

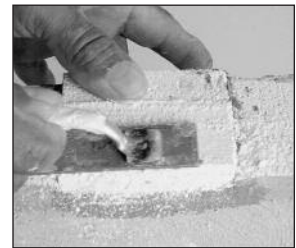

photo:Arnold Howard

Step 7

8 Remove excess cement while it is still wet. Allow to dry for 24 hours. Then sand the surface smooth if necessary.

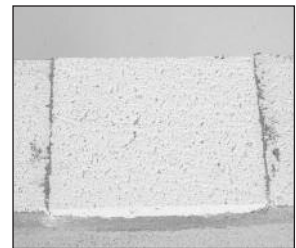

photo:Arnold Howard

Step 8

Plugging a Drilled Firebrick Hole

You can make a firebrick insert to fill a drilled firebrick hole:

1 Cut a firebrick that is the same length as the width of the kiln wall and slightly larger than the hole you are filling.

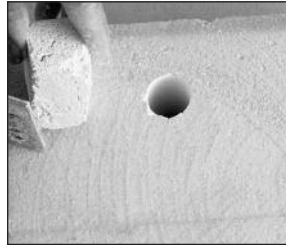

photo:Arnold Howard

Step 1

2 With a sanding block, round the firebrick piece. It should be $\frac{1}{16}$ " smaller in diameter than the hole.



photo:Arnold Howard

Step 2

3 Coat the plug with repair cement and insert into the hole until the plug is flush. Wipe off excess cement. If necessary, sand after the cement has dried.



photo:Arnold Howard

Step 3

Cementing Broken Pieces

Broken firebrick pieces can be cemented together provided there is enough surface area for the bond.

1 Use a brush, vacuum cleaner, or canned air to remove the dust. (Wear safety glasses when using canned air.)

2 Spray a fine mist of water onto all mating brick surfaces. Mix 1 drop of liquid dishwashing soap to 1 cup of water. The soap reduces surface tension of the water to help it absorb into the bricks.

3 Working rapidly before the water dries out, wipe firebrick repair cement onto mating surfaces.



photo:Arnold Howard

Step 3

4 Press the piece tightly into place. Do not move it once the mating surfaces make tight contact. Hold the brick piece for 1 minute.



photo:Arnold Howard

Step 4

5 Allow to dry for 24 hours. Then sand smooth if necessary.

Cementing Flat Sections

When cementing firebricks together, make the cement seam as thin as possible: $\frac{1}{32}$ "– $\frac{1}{16}$ ". If the seam is too thick, it will break due to the difference in expansion between the bricks and the cement.

The ideal way to cement bricks together is along mating flat surfaces, because sliding the surfaces together after applying the cement makes a very thin seam.

- 1 First, the bricks you are cementing should fit as precisely as possible. Rub the surfaces with a sanding block, and then rub them against each other until they slide smoothly. Vacuum all surfaces.
- 2 Pour the cement into a 12" x 36" galvanized steel or plastic tray.
- 3 Do not spray or soak the mating brick surfaces in water. That is unnecessary, because by dipping into a tray, you can coat the entire brick surface with cement in several seconds leaving plenty of time to work with the cement. Of the two surfaces you are cementing, dip only one surface into the cement tray. Leave the mating surface dry of cement.

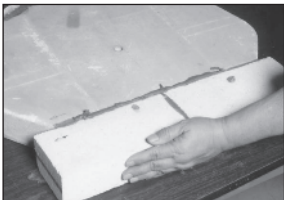

photo: Arnold Howard

Cement in new brick.



photo: Arnold Howard

Cut and sand to shape.

4 After dipping the bricks into the tray, do not wipe off excess cement. Also, do not be concerned with trying to cover the entire brick surface with cement. The cement may cling to the outer edges and not to the inner section of the surface that you have dipped. That's okay.

5 Slide the mating surfaces together. If the cement is mixed with the proper proportion of water, the brick surfaces will slide together smoothly. To achieve a $\frac{1}{16}$ " – $\frac{3}{32}$ " seam, slide the surfaces back and forth about 5 times, sliding about 3" before changing the direction. Each time you change directions, the seam will become thinner. In a few seconds, it will be difficult to slide smoothly. The cement has set. Stop moving the pieces.

6 Allow the cement to dry. After 24 hours you can lift the brick sections without breakage.

Wall Repairs

Repairing Firebricks with Element Staples

In some cases, element staples (also called pins) can hold small broken brick sections together:

- 1 Bend a U-shaped element staple with pliers to form an L shape.
- 2 Fit the broken brick piece back into the wall where it fell out.
- 3 Grasp an element staple with pliers, and press the staple at an angle into the broken brick piece. Use two staples tilted away from each other. (Pressing the staples in at an angle holds the broken brick better than pressing the staples straight in.) Press the staples until flush with the surface of the firebrick. Be careful to avoid pressing a staple into an element. The staple should also be short enough so that it does not touch the kiln case on the other side of the brick wall.

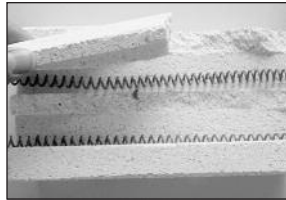

Step 3.

photo: Arnold Howard

Alternately, you can pin elements in place where a brick groove has broken off. This will prevent elements from sagging and touching. Press the element pin over only one element coil.

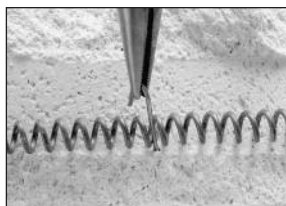

Pin the element in place.

photo: Arnold Howard

Lid Repairs

Repairing Lid Cracks

Dust may fall from cracks in the lid. This does not affect ceramic greenware, but dust can ruin glazed ware and glass. Before a glaze or glass firing, vacuum the lid cracks. If dust continues to fall even after vacuuming, load the kiln so that ware on the top shelf is away from the lid cracks.

You can also stuff the cracks with ceramic fiber. The cracks must be at least $\frac{1}{16}$ " wide. Hairline cracks are too small to accept the ceramic fiber.

- 1 Roll the ceramic fiber in the hands to form a pencil-like strand.
- 2 Press it into the cracks with a small stick or putty knife being careful not to damage the firebricks further.

Sometimes tightening a loose lid band helps to keep cracks from opening wider:

- 1 Grasp the clamp with pliers to prevent the clamp from twisting.
- 2 Tighten the screw to take up the slack in the lid band. Tighten until the screw feels snug. Try not to over-tighten.



Step 1.

photo: Arnold Howard

*Arnold Howard and Frances Darby
can be reached at: paragonweb.com*

Electric Firing and Tiles, Commercial Firing by Stephani Stephenson

Though I love the flame of a gas or wood kiln, my 21st century kiln is a 35-year-old Cress electric CH8.

You sometimes see these old behemoths in the backs of school studios with their wiring fried, soft brick crumbling, and switches and elements in disrepair. Ten years ago I purchased a used one in great condition for \$100. I borrowed a truck and an engine hoist and hauled it to my studio, where I now keep it on blocks so I can easily move it with a pallet jack. Over the years I have come to respect this heavy, boring, dour, welded box. I have worked it continually, and it has not let me down.

Electricity Use

Compared to similarly sized kilns, this kiln draws only 35 amps, which is an important consideration when sizing up breaker box capacity, especially in older or residential studios. With beefy 7"-thick walls and lid, it doesn't use much electricity and retains heat like a greedy miser. In fact, the kiln will keep ware warm for a week, if the lid is not cracked for cooling. The ability to slow cool without the use of a controller or firing down changed and improved my glaze palette. Following are a few tips on how I stack and fire tile in my kiln.

Stacking and Firing Tips

I single fire large relief tiles by placing glazed, bone-dry tiles on clay strips. I make the strips out of a coarse A clay body. I run strips the length of the tile and space them 2 inches apart. I run my finger down the center of some of the strips to form shallow gutters, which will catch



photo: Stephani Stephenson

Stephani Stephenson's kiln.

any glaze drips from glazed tile edges. Sometimes I fire large glazed tiles on a $\frac{1}{16}$ " layer of silica sand placed on the kiln shelf. I rake the sand into an even thickness before placing the shelf in the kiln, making sure no sand falls to the shelf or tile below.

To bisque, or fire non-vitreous stained tiles, I stack tiles on end, just like slices in a loaf of bread. Bookend each loaf with kiln posts, small bricks, or tile stacks, to hold the slices snugly in place. Large unglazed tiles and field tile are easily fired on end as well.

Allow for Air Circulation

The kiln load, stacked in this way, can have a good deal of mass and density and can, in fact, be stacked too densely. You want to put as much ware as possible into the kiln, yet allow for some air circulation. When stacking a glaze load, I keep in mind whether my glazes require

an oxygen rich or oxygen-deprived atmosphere, and stack accordingly. (Yes, it is possible to have a reduction firing in an electric kiln!) I leave about 2" clearance between the ware on the bottom shelf and the next shelf up, then leave about ½" clearance for the rest of the shelves. If you notice incomplete burnout or over-reduced glazes, open up the load by inserting a few spacer stilts between tiles or by leaving a bit more clearance between shelves. If the kiln seems to stall or take too long to fire, check your elements and your switches. As the mass of the load increases, the kiln may fire slightly slower but should still climb steadily and readily.

Shelving

My relief tiles are too large and thick for standard tile setters, but not heavy enough to need thick refractory shelves. There is no need to fill valuable small kiln space with excessive refractory or pay good money to heat thick shelves. When a commercial tile manufacturer went out of business, I bought some thin mullite shelves, serrated on one side. At one dollar apiece, the shelves were affordable and entirely sufficient for my cone 04–cone 2 firing range.

Pay Attention to the Pyrometer

I do not follow a specific regimen with regard to how and when I turn switches on my kiln. Timing depends on the mass of the ware, the stack, thickness, clay body, and glazes. With a light load, if I turn all switches on to low and close the lid, the temperature climbs rapidly, possibly too rapidly for thick pieces or a fine clay body. Rather than a strict schedule, I pay attention to the pyrometer and the color and

how much the lid is cracked or closed during the first part of the firing. I will generally start with the bottom 2 switches on low and the lid cracked 1–4 inches. The kiln will usually reach 100°C in 1–2 hours. I then turn the rest of the switches to low. After another hour, at about 300–400°C, I will turn all switches to medium and close the lid. If there is an unusually heavy A load I leave the lid cracked longer and take it up a little slower to allow for thorough out gassing. An hour or two later, switches go to high. I look for a gradual, not spiky rise in temperature. I fire as fast and smooth as I can get away with, taking 1–2 hours to go through the first 100°C, then a moderately fast steady climb all the way to temperature, taking care not to flip switches through quartz inversion.

Be Present when the Kiln Is Near Temperature

I have learned to be present when the kiln is near temperature. Though the kiln has a timer to back up the cone sitter, both can potentially fail. I am careful because I have overfired my kiln. Once I check two pyrometers and the color, I am there to manually shut the kiln off if I feel it is hot enough. The kiln's peepholes are too small to see a guide cone, but guide cones can periodically be placed at different places in the kiln to check against your pyrometer and to remind yourself about color and temperature.

After Shutoff

Once the kiln shuts off, I usually prop open the lid ½" with a piece of kiln shelf. Sometimes I do this right away. Sometimes not. The prop is long enough to rest on the welded frame, so it does not damage the underlying soft brick. Depending on the load, the glazes, and the clay,

I will gradually insert additional pieces of cut kiln shelf, being careful not to introduce cool air during quartz inversion. Take notes and pay attention to determine the best firing schedule for your needs.

Generally I fire up from 6–10 hours, depending on the load, and cool down for 8–12 hours.

Kiln Maintenance

Electric kilns have long been the salvation of urban and suburban tile makers and potters working in rented, residential, basement or garage studios. In many ways, the dependability and convenience of electric kilns can lead to inattention or ignorance in maintenance and repair. It is so easy to simply flip switches and forget them. My kiln has 5 switches and 5 elements. Each element is 33 feet long. It will continue to fire fairly well even when running three of the five elements. But do not let this happen! Keep a couple of extra switches on hand, because they can fail with no warning. Periodically open the switch box and inspect the wiring and replace any worn or fried wiring. Inspect and replace broken or aging elements and re-pin elements where needed. Take care of the soft brick and vacuum the interior of the kiln regularly. Get into the habit of understanding and maintaining your kiln. I no longer take my electric kiln for granted. It has been a real workhorse and has earned its keep many times over.

Stephani Stephenson can be reached at: revivaltileworks.com

Downfiring an Electric Kiln by Carol Marians

“Downfiring” is what potters call the controlled cooling of a kiln—from top temperature (where the desired cone has properly bent or “squatted”) to room temperature. Ideally this is done with the help of a computer control, but is feasible with “just” a pyrometer. The important part is “to know when to hold” and when to let the kiln cool some more.

We downfire in order to achieve the enormous and exciting variety of colors and textures. that may be gotten. If a glaze is sensitive to cooling-and-holding, then it is up to the potter to find the exact combination to achieve the “best” result.

Examining a Glaze Up-Close

Note: The recipe for the Chinle glaze discussed here and micrographs of the glaze may be seen at 21stcenturykilns.com.

If you were to look at the Chinle glaze with a 30x rock-hounding loupe you would find a variety of textures and colors. What examination reveals first is that the smooth uniform surface of the glaze on your pot turns into a Pointillist painting. Your glaze tile looks like what you see from an airplane flying over a desert.

1. Glassy red rivers, showing mottling. Dark islands of material submerged under a liquid surface.
2. Textured islands—pale green, waxy, with fan-like crystal needles, some of which seem to float in a glassy red sea.
3. Sheaf like fans of crystals rise on top of waxy islands. Crystal “sails.”

4. The waxy islands have scalloped, irregular edges—like breakers hitting a beach.
5. Fine pink blooms.
6. The pale green islands now look like ice floes—opaque and thick in the middle, transparent at the edges. The microscope transforms this “simple” glaze into a fantastic landscape inhabited by an abundance of different rocks and structures.

The micrographs were taken of the same glaze on the same pot, but at different places on the pot. Pay attention to the systematically changing width of the maroon rivers, and the textural difference in the waxy green islands from one to the other micrograph.

Just to repeat: In this single glaze, fired under controlled, selected conditions, there are at least four different kinds of crystalline material: waxy pale green; needle-like fan; sheets of reflecting material; lacy pale pink bloom.

Any crystal that can be born and grow in a glaze does so only within a narrow, “favorite” temperature range. Crystals grow and compete for space, forming domains of varying size. They actually compete for the same materials, just as different plants in a forest compete for the nutrients in the soil.

And, just as in a forest, some plants need the shelter of others in order to thrive, so in a glaze the crystals both compete and cooperate; “fighting” over materials, “co-operating” when crystal A grows on crystal B. Changes in rate of cooling alters possibility. Change the rate of cooling and crystal A grows, but instead of forming a great many tiny crystals, grows a few

giant ones. Change the rate of cooling and crystal A, which needs high temperatures, stops growing when it gets too cold! Thus making “its” materials available to crystal B.

Some Pointers

- Because air/heat circulate in a kiln, and the kiln bricks and furniture, which absorb about 50% of the heat, radiate it back into the kiln, a kiln held at top temperature—let us say cone 6—very well might “drop” its cone 7 if the heat is held/kept too close to the desired firing temperature. It is advisable, therefore, to let the kiln cool at least 50° F (~27°C) before any holds.
- In the technical literature there are reports that 1100° F (~593°C) allows some crystals to grow in glass. These crystals are produced for a melted glass that then is “frozen” and finally held at a lower temperature to allow for crystal formation. It is probable that the same process can be replicated in glazes.
- There are reports that high iron glazes fired to maturity at cone 6 (2201°/1205°C) will form a different and often exciting color when re-fired to cone 04. The same effect may be obtainable by holding the cone 6 firing at 1940° F/1060°C.

Getting Started

It is extremely desirable to have a small test kiln when working out coolings and holds schedules.

These kilns are as costly as others (cubic inch by cubic inch); they cost more than larger kilns, but if you are serious about glaze, and particularly about coolings and holdings they are a good investment.

Choosing a single glaze, make up a test batch that will allow for several tests. Make up enough so that you have plenty left for later reference-firings. (You do not want to question later results, wondering if you weighed things out correctly, or if a new batch of glaze material was different from the one you started with!)

Choose a high iron glaze, or one that hovers between shiny and matte—some glaze whose composition promises shocks and surprises! (Many are the glaze tests we have done because one sentence in one book suggested something new and different!)

Picking the Glaze

Most glazes are sensitive to the downfire. However, just as there are places on Earth where nothing grows, or so slowly one wouldn't notice it in a human lifetime, so there are glazes where the hold times would have to be hundreds of hours.

Then there are the glazes which will only grow crystals if held for an hour at say 1600°F (~871°C). Nothing else will do. But its perfect holding temperature might be 1450°F (~787°C) instead, and so on.

So how would you know which properties make a glaze a likely candidate for something that happens almost anywhere between sunup and sundown, i.e., top and frozen?

How Would You Guess Which Glaze to Try?

There are three “lighthouses” to guide you:

1. Contains .1000 Rutile or Bone ash or Zinc
2. Is moderate or high in MgO (the Empirical Formula has $MgO > .1$)
3. The Empirical Formula is $Al_2O_3 > .4$ or $SiO_2:Al_2O_3 < 7$

All your firings must include a cone below and a cone above your desired temperature. For example, for a cone 6 firing you use a cone 5 (cone 6), and a cone 7 as well. (*Note: If you are new to this, be aware that the temperature difference between cones is NOT consistent.*)

Be aware that the “squatting” of regular standard cones, and the self-supporting ones, is not the same, nor is the deformation temperature of junior cones. We recommend standard cones—either type—or use as visual cones in the kiln. It does not matter whether you use self-supporting or regular, just be consistent!

First Firing Test

You begin with a reference firing to establish the “baseline.” If the result of the reference firing is a smooth, glassy, transparent, featureless glaze even at 30x magnification, it probably is unsuitable for your purposes.

Second Firing Test

With the next firing, cool the kiln from cone 6 to 1500°F (~ 865°C) at the rate of 150°F per hour (~83°C).

Third Firing Test

If there is a change in glaze appearance between the first and second test firing, slow down the cooling speed of the third firing to 50°F

(~28°C) an hour. Remember that you need to cool the kiln at normal rate from top temperature to 2150°F (~1226°C) or you risk overfiring.

Examine your results, observe the changes in the glaze's appearance and "feel," and make good clear, detailed notes.

Compare the Results

Compare the results of your three firings. You now might proceed with firings like this:

Firing A: downfire from cone 6 to 1800°F (982°C); turn kiln off.

Firing B: Let the kiln cool "naturally," on its own, to 1800°F (~982°C) then cool at 50°F (~28°C) an hour to 1500°F (~815°C). The object is to see if different schedules show any different results.

About Holds

Holds are an extreme form of slow downfiring. If you find that a glaze continues getting more interesting with slow firing in the region 1600°F (~870°C) to 1400°F (760°C), you might try a hold somewhere in that interval.

You get the idea. You think carefully about the results obtained by different coolings and holds. You follow your hunches. If you are working with two similar glazes you might notice that glazes containing a big amount of material X "like" being cooled quickly from the top, and slowly to the bottom. Or that a particular shade of pink is favored by a slow drop and a long hold.

Mastering Downfiring

We need to caution you! Mastering downfiring with all its zigs and zags not only takes hard work and the ability to absorb a great deal of

disappointment and frustration, but it takes an enormity of continuous time. Furthermore, while certainly a small test kiln consumes less wattage than a big kiln, this is not an inexpensive project. Electricity costs vary quite a bit from one part of the country to another, so this may or may not be affordable where you live!

If you are doing this manually—using a pyrometer—then, ironically, you cannot put your "holds" on hold! You must stay in the kiln room, focusing on exactly what you are doing—even if it takes ten hours (or more).

If you are using an electronic controller, it has been programmed up front, and there wouldn't be any point staying with the kiln while it fires. You do not need to stay in the kiln room. You need to be nearby, able to check repeatedly that all is well.

Firing Multi-Zone Kilns

If you are firing a multi-zone kiln, you must load it thoughtfully. Multi-zone kilns have pyrometers in every zone. Each "reports" to the controller. If there is empty space at the top of the kiln, or some large "open" area in the middle, the pyrometer for that zone will give a "false" report, and cause misfirings. If you do not have enough pottery to fill the kiln, with the ware distributed evenly, then add an empty shelf, and put enough kiln furniture on it to "fool" the pyrometer into thinking "pots" and reporting accurately to the controller.

Last: there are no guarantees or givens. I do not know what the crystals are, how they relate, nor anything specific about why they form in certain hold and cool patterns.

*Carol Marians can be reached at:
carol.knighten.org*

Have Courage

There are many ways to build a kiln. It is just a brick box that you fill with heat. Some get caught up in architecture, some in untried design, but the bottom line is and always will be “how does it fire”?

Being wise, prudent and a good home-based engineer is still the key. Understand why you fire the way you do and what alternatives you have. Can you save money by changing your system? We are a world that is “about change,” so why not change how you build and fire your kiln?

Why would you build a kiln with 19th century ideas? Well, it is being done every day. There is strong speculation that the wood fired kiln illustrated in the Daniel Rhodes’ book, *Kilns* was never built before publication; it was a theory of a friend. In most aspects, that kiln does not fire well and is a total failure in design. Yet, folks are still building wood-fired kilns from that plan. No kiln should ever be built that does not meet tested results.

With the skills you have learned here, you can now make a kiln on your property—a tried and true design and a super-firing kiln that is inexpensive to operate and maintain.

Research and study are key. Conversations with potters that have built the kind of kiln you want will be very helpful. Join the Clayart listserv (find the link at 21stcenturykilns.com) and ask questions.

Do an Internet search for information. Go to the library, but be wary of old books. Read old books for basic historic information, but don’t be fooled by pretty pictures of untested kilns.

Learn and understand new concepts like “firing down.” Understand that more things of interest happen during cooling than heating.

In most cases, you will be able to build a kiln at your home studio. Don’t let fear and worry about rules and regulations stop you. Consider the variables and start making your plan.

Don’t scrimp on materials. Invest in yourself. Invest in your future—the far distant future. Look ahead 50 years.

You have seen what others have done. You have seen the films and read the stories of kilns built by potters, just like you.

It is time to plan and then build. Yes, you can do it. Courage.



Mel

*Mel Jacobson can be reached at:
21stcenturykilns.com*